

Diaphragm pressure gauge For the process industry Models 432.50, 433.50, up to 10-fold overload safety, max. 40 bar

WIKA data sheet PM 04.03



for further approvals
see page 3

Applications

- For measuring points with increased overload
- With liquid-filled case suitability for high dynamic pressure loads and vibrations (model 433.50)
- For gaseous, liquid and aggressive media, also in aggressive environments
- With the open connecting flange also suitable for contaminated and viscous media
- Process industry: Chemical, petrochemical, power plants, mining, on-/offshore, environmental technology, machine building and general plant construction

Special features

- Case and wetted parts from stainless steel
- Wide choice of special materials
- High overload safety up to the 10-fold full scale value
- Process connection thread or open flange
- Scale ranges from 0 ... 16 mbar

Description

Diaphragm pressure gauges are preferably used for low pressure ranges. Through the large working surface of the circular, corrugated diaphragm element, small pressure ranges can be measured reliably.

The model 432.50 diaphragm pressure gauge is manufactured in accordance with EN 837-3. The high-quality design is particularly suitable for applications in the chemical and petrochemical industry, oil and gas industry and power engineering.

The case and wetted parts from stainless steel fulfil high requirements for resistance against aggressive media. For especially high resistance requirements, the pressure chamber can be designed with a wide variety of special materials such as PTFE, tantalum or Hastelloy.



Diaphragm pressure gauge model 432.50

For the measurement of highly viscous, crystallising or contaminated media, the use of an open connecting flange is recommended. The open connecting flange has the advantage over a threaded connection that the pressure port cannot become blocked. With an additional flushing bore on the open connecting flange, the pressure chamber can be easily cleaned.

Measuring systems with diaphragm elements, on the grounds of their design, offer good protection from overpressure, since the diaphragm can support itself against the upper flange. As standard, the model 432.50 diaphragm pressure gauge already features an overload safety of 5 times the full scale value. Versions with higher overload safeties can be realised.

Specifications

Design

EN 837-3

Nominal size in mm

100, 160

Accuracy class

1.6

Scale ranges

0 ... 16 mbar to 0 ... 250 mbar (flange Ø 160 mm)
0 ... 400 mbar to 0 ... 25 bar (flange Ø 100 mm)
or all other equivalent vacuum or combined pressure and vacuum ranges

Pressure limitation

Steady: Full scale value
Fluctuating: 0.9 x full scale value

Overload safety

5 x full scale value, however max. 40 bar

Permissible temperature

Ambient: -20 ... +60 °C
Medium: +100 °C maximum
Storage: -40 ... +70 °C
(scale ranges ≤ 60 mbar: -20 ... +70 °C)

Temperature effect

When the temperature of the measuring system deviates from the reference temperature (+20 °C): max. ±0.8 %/10 K of the span

Ingress protection per IEC/EN 60529

Model 432.50: IP54
Model 433.50: IP65 (with liquid filling)

Process connection with lower measuring flange

Stainless steel 316L, G ½ B (male), SW 22

Pressure element

≤ 0.25 bar: Stainless steel 316L
> 0.25 bar: NiCr-alloy (Inconel)

Pressure chamber sealing

FPM/FKM

Movement

Stainless steel

Dial

Aluminium, white, black lettering

Pointer

Aluminium, black

Case with upper measuring flange

Stainless steel, safety level "S1" per EN 837:
With blow-out device
Instruments with liquid filling with compensating valve to vent case

Window

Laminated safety glass

Ring

Bayonet ring, stainless steel

Filling liquid (for model 433.50)

Glycerine-water mixture









Other versions

- Other process connection
- Safety level "S3" per EN 837: With solid baffle wall and blow-out back, model 43x.30
- Overload safety: 10 x full scale value, max. 40 bar
- Vacuum resistant to -1 bar
- Max. medium temperature +200 °C
- Permissible ambient temperature -40 ... +60 °C (silicone oil filling)
- Higher indication accuracy, class 1.0
- Open connecting flanges per DIN/ASME from DN 15 to DN 80 (preferred nominal widths DN 25 and 50 or DN 1" and 2" per data sheet IN 00.10)
- Wetted parts lined/coated with special materials such as PTFE (model 45x.50), Hastelloy, Monel, nickel, tantalum, titanium, silver (accuracy class 2.5, overload safety on request)
- With a flushing bore on the open connecting flange
- Diaphragm pressure gauge with switch contacts, model PGS43.1x0, see data sheet PV 24.03
- Pressure gauge with output signal, model PGT43.1x0, see data sheet PV 14.03

Accessories

Sealings, model 910.17, see data sheet AC 09.08

Approvals

Logo	Description	Country
	EU declaration of conformity ATEX directive (option) Hazardous areas - Ex c Gas II 2 G c IIC TX X ¹⁾ Dust II 2 D c TX X	European Union
	EAC (option) Hazardous areas	Eurasian Economic Community
	GOST (option) Metrology, measurement technology	Russia
	KazInMetr (option) Metrology, measurement technology	Kazakhstan
-	MTSCHS (option) Permission for commissioning	Kazakhstan
	BelGIM (option) Metrology, measurement technology	Belarus
	UkrSEPRO (option) Metrology, measurement technology	Ukraine
	Ex-Ukraine (option) Hazardous areas	Ukraine
	Uzstandard (option) Metrology, measurement technology	Uzbekistan
-	CPA (option) Metrology, measurement technology	China
-	CRN Safety (e.g. electr. safety, overpressure, ...)	Canada

1) For instruments with PTFE lining, measures must be taken in the lining area, if necessary, in order to exclude electrostatic charging.

Certificates (option)

- 2.2 test report per EN 10204
(e.g. state-of-the-art manufacturing, material proof, indication accuracy)
- 3.1 inspection certificate per EN 10204
(e.g. material proof for wetted metal parts, indication accuracy)
- Others on request

Approvals and certificates, see website

Dimensions in mm

Standard version

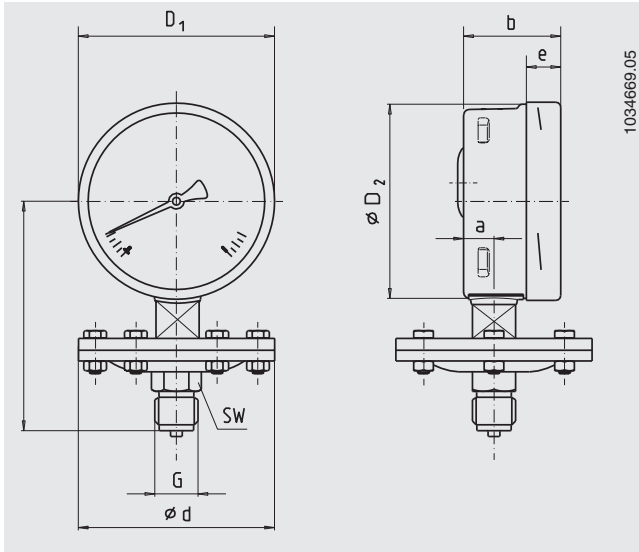

NS	Scale range	Dimensions in mm									Weight in kg
	in bar	d	a	b	D_1	D_2	e	G	h ±2	SW	
100	≤ 0.25	160	15.5	49.5	101	99	17.5	G ½ B	119	22	2.50
160	≤ 0.25	160	15.5	49.5	161	159	17.5	G ½ B	149	22	2.90
100	> 0.25	100	15.5	49.5	101	99	17.5	G ½ B	117	22	1.30
160	> 0.25	100	15.5	49.5	161	159	17.5	G ½ B	147	22	1.70

Process connection per EN 837-3 / 7.3

Ordering information

Model / Nominal size / Scale range / Process connection / Connection location / Options

© 10/2008 WIKA Alexander Wiegand SE & Co. KG, all rights reserved.
The specifications given in this document represent the state of engineering at the time of publishing.
We reserve the right to make modifications to the specifications and materials.

