

5 Port Solenoid Valve

SY3000/5000/7000/9000 Series

Rubber Seal

The SS5Y3/5-45T/T1□ type plug-in terminal block manifold is to be discontinued as of December 2019. Therefore, we recommend considering the SY3000/5000/7000 plug-in connector connecting base terminal block box type manifold as a substitute. ([Click here](#) for details.) However, keep in mind that there is no specification or mounting compatibility between the two products.

CE cUL[®] US
 [Option] (30-SY → From page 630)

SJ

SY

SY

S0700

S0700

Power Consumption
0.1W*
 With Power Saving Circuit

* For details, refer to page 636.



• Flow Rate Characteristics

Series	Flow rate characteristics		
	C [dm ³ /(s·bar)]	b	Cv
SY3000	1.1	0.28	0.29
SY5000	2.8	0.37	0.90
SY7000	4.5	0.28	1.4
SY9000	10	0.29	2.5

• Long service life

* Please contact SMC if life test data is required.

Valve Variations

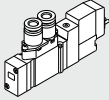
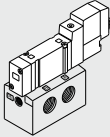



	Series	Sonic conductance C [dm ³ /(s·bar)] { 4/2→5/3 (A/B→EA/EB)}	Actuation					Voltage		Electrical entry				Light/surge voltage suppressor <small>(Note 1)</small>	
			2 position		3 position			DC 24 V 12 V 6 V 5 V 3 V	AC 100 V 50/60 Hz 110 V 50/60 Hz 200 V 50/60 Hz 220 V 50/60 Hz	Grommet	L plug connector	M plug connector	DIN terminal <small>(Note 4)</small>		M8 connector
			Single	Double	Closed center	Exhaust center	Pressure center								
Body ported	P.404 	SY3 □ 20	0.65	●	●	●	●	●	●	●	●	●	●	●	
		SY5 □ 20	2.4	●	●	●	●	●	●	●	●	●	●	●	●
		SY7 □ 20	3.3	●	●	●	●	●	●	●	●	●	●	●	●
		SY9 □ 20	8.6	●	●	●	●	●	●	●	●	●	●	●	●
Base mounted	P.420 	SY3 □ 40	1.1	●	●	●	●	●	●	●	●	●	●	●	
		SY5 □ 40	2.8	●	●	●	●	●	●	●	●	●	●	●	●
		SY7 □ 40	4.5	●	●	●	●	●	●	●	●	●	●	●	●
		SY9 □ 40	10	●	●	●	●	●	●	●	●	●	●	●	●

SJ
SY
SY
S0700
S0700

	Series	Manual override				P, EA, EB port size				A, B port size								Valve option										
		Non-locking push type	Push-tum locking slotted type	Push-tum locking lever type	Bracket	M5	1/8	3/8	1/2	M5	1/8	1/4	3/8	1/2	One-touch fitting					Exhaust throttle	Or resistant (Other than designated tubing oil)	Vacuum specifications	Low pressure specifications	Dual pressure	Enclosure IP65 <small>(Note 3)</small>	Interface regulator	3 Port valve SY	
															C4	C6	C8	C10	N3									N7
Body ported	SY3 □ 20	●	●	●	●				●						●	●												●
	SY5 □ 20	●	●	●	●		●								●	●												●
	SY7 □ 20	●	●	●	●			●	●		●					●	●					●	▲	▲	▲	▲		●
	SY9 □ 20	●	●	●						●	●					●	●											●
Base mounted	SY3 □ 40	●	●	●		●			●																		●	
	SY5 □ 40	●	●	●			●			●																	●	
	SY7 □ 40	●	●	●					●	●																	●	
	SY9 □ 40	●	●	●			●	●			●																●	

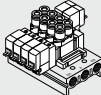
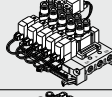
● Standard ● Option ▲ Made to order (Refer to page "Made to Order")
 Note 1) All AC voltage models have built-in surge voltage suppressor.
 Note 2) Body ported external pilot type (made to order) is not available for DIN terminal.
 Note 3) Only available for DIN terminal and M8 connector.
 Note 4) SY3000 does not have a DIN terminal which can be connected to a manifold.

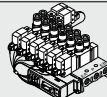

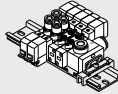









Manifold Variations

Manifold Variations				Valve Series	Wiring									
					Connection							Common specifications		
				5 port	Individual wiring	Flat ribbon cable (26 pins)	Flat ribbon cable (20 pins) connector box	Plug-in type D-sub connector (25 pins)	Plug-in type flat ribbon cable (26, 20, 10 pins)	Plug-in type terminal block (9, 18 pins)	Serial transmission unit	Positive common	Negative common	
Body ported	Bar stock type Individual wiring ■ Direct piping to the main unit of a valve. Combination of different fittings is possible.		Type 20 P. 438	SY3□20	●	—	—	—	—	—	—	—	—	
				SY5□20	—	●	—	—	—	—	—	—	—	—
				SY7□20	—	—	—	—	—	—	—	—	—	—
	Bar stock type Flat ribbon cable ■ A 26 pins MIL connector permits One-touch wiring of external cables in a bundle.		Type 20P P. 448	SY3□20	—	●	—	—	—	—	—	—	● <small>Note)</small>	
				SY5□20	—	●	—	—	—	—	—	—	● <small>Note)</small>	
				SY7□20	—	—	—	—	—	—	—	—	● <small>Note)</small>	
	Stacking type Individual wiring ■ Manifold stations can be increased or decreased.		Type 23 P. 444	SY9□20	●	—	—	—	—	—	—	—	—	
				SY9□20	—	●	—	—	—	—	—	—	—	● <small>Note)</small>
	Stacking type Flat ribbon cable ■ Manifold stations can be increased or decreased.		Type 23P P. 454	SY9□20	—	●	—	—	—	—	—	—	● <small>Note)</small>	
				SY9□20	—	●	—	—	—	—	—	—	● <small>Note)</small>	
	Bar stock type EX510 gateway type ■ Can be used with a serial transmission system.		Type 20SA P. 458	SY3□20	—	—	—	—	—	—	—	●	—	
				SY5□20	—	—	—	—	—	—	—	—	●	
SY7□20				—	—	—	—	—	—	—	—	—		
Stacking type EX510 gateway type ■ Can be used with a serial transmission system.		Type 23SA P. 464	SY9□20	—	—	—	—	—	—	—	●	—		
Cassette type Individual wiring ■ Size and weight reduced by eliminating the manifold base		Type 60 P. 472	SY3□60	●	—	—	—	—	—	—	—	—		
			SY5□60	●	—	—	—	—	—	—	—	—	—	
			SY7□60	●	—	—	—	—	—	—	—	—	—	

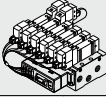
● Standard ● Option ▲ Made to order (Refer to page "Made to Order".)

Note) When there are polarities, the positive common specifications are used.

Manifold Variations

Manifold Variations		Valve Series	Wiring											
			Connection							Common specifications				
			Individual wiring	Flat ribbon cable (26 pins)	Flat ribbon cable (20 pins) connector box	Plug-in type D-sub connector (25 pins)	Plug-in type flat ribbon cable (26, 20, 10 pins)	Plug-in type terminal block (9, 18 pins)	Serial transmission unit	Positive common	Negative common			
Base mounted	Compact bar stock type Individual wiring ■ The base mounting facilitates maintenance after valves are changed.		Type 41 P. 490	SY3□40	●	—	—	—	—	—	—	—	—	
	Compact bar stock type Flat ribbon cable ■ A 26 pins MIL connector permits one-touch wiring of external cables in a bundle.		Type 41P P. 506	SY3□40	—	●	—	—	—	—	—	—	● Note) In common	—
	Bar stock type/Common external EXH Individual wiring ■ The base mounting facilitates maintenance after valves are changed. ■ Vacuum/low pressure combination system is possible.		Type 42 P. 490	SY3□40	●	—	—	—	—	—	—	—	—	—
	Bar stock type/Common external EXH Flat ribbon cable ■ A 26 pins MIL connector permits one-touch wiring of external cables in a bundle. ■ Vacuum/low pressure combination system is possible.		Type 42P P. 506	SY3□40	—	●	—	—	—	—	—	—	● Note) In common	—
	Stacking type Individual wiring ■ Manifold stations can be increased or decreased.		Type 43 P. 500	SY9□40	●	—	—	—	—	—	—	—	—	—
	Stacking type Flat ribbon cable ■ Manifold stations can be increased or decreased.		Type 43P P. 514	SY9□40	—	●	—	—	—	—	—	—	● Note) In common	—
	Bar stock type EX510 gateway type ■ Can be used with a serial transmission system.		Type 42SA P. 520	SY3□40	—	—	—	—	—	—	●	—	—	—
	Stacking type EX510 gateway type ■ Can be used with a serial transmission system.		Type 43SA P. 525	SY9□40	—	—	—	—	—	—	●	—	—	—
	Stacking type/DIN rail mounted Individual wiring ■ Stations can be increased on the DIN rail. Integrated mounting of other electric parts is possible, too.		Type 45 P. 536	SY3□40	●	—	—	—	—	—	—	—	—	—
	Stacking type/DIN rail mounted Connector box ■ Stations can be increased or decreased on the DIN rail. The provided connector box permits one-touch connection of electric cables.		Type 45^A_{NA} P. 548	SY3□40	—	—	●	—	—	—	—	—	●	●
	Stacking type/DIN rail mounted EX510 gateway type ■ Can be used with a serial transmission system.		Type 45S6A P. 556	SY3□40	—	—	—	—	—	—	●	—	—	—
	Stacking type/DIN rail mounted Plug-in ■ Stations can be increased or decreased on the DIN rail. ■ A variety of centralized wiring methods are possible.		Type 45I P. 564	SY3□40	—	—	—	●	●	●	●	●	●	●
	Stacking type/DIN rail mounted Plug-in EX510 gateway type ■ Can be used with a serial transmission system.		Type 45S6B P. 604	SY3□40	—	—	—	—	—	—	●	—	—	—

● Standard ● Option ▲ Made to order (Refer to page "Made to Order".)
 Note) When there are polarities, the positive common specifications are used.

INDEX

Cylinder Speed Chart	P.398
Valve Variations	P.399
Manifold Variations	P.400

5 Port Solenoid Valve

■ Single Unit

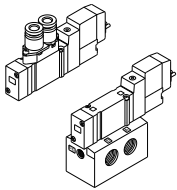

Body Ported	P.404
Base Mounted	P.420

■ Body Ported Manifold

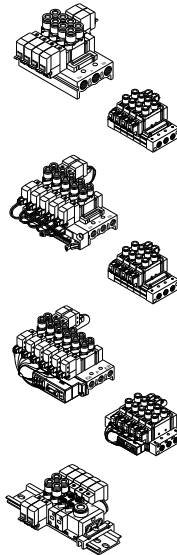

Type 20 Bar Stock Type/Individual Wiring	P.438
Type 23 Stacking Type/Individual Wiring	P.444
Type 20P Bar Stock Type/Flat Ribbon Cable	P.448
Type 23P Stacking Type/Flat Ribbon Cable	P.454
Type 20SA Bar Stock Type/EX510 Gateway-type	P.458
Type 23SA Stacking Type/EX510 Gateway-type	P.464
Type 60 Cassette Type/Individual Wiring	P.472

■ Base Mounted Manifold

	Type 41 Bar Stock Type/Compact Type/Individual Wiring	P.490
	Type 42 Bar Stock Type/External Pilot Capable/Individual Wiring	P.490
	Type 43 Stacking Type/Individual Wiring	P.500
	Type 41P Bar Stock Type/Compact Type/Flat Ribbon Cable	P.506
	Type 42P Bar Stock Type/External Pilot Capable/Flat Ribbon Cable	P.506
	Type 43P Stacking Type/Flat Ribbon Cable	P.514
	Type 42SA Bar Stock Type/EX510 Gateway-type	P.520
	Type 43SA Stacking Type/EX510 Gateway-type	P.525
	Type 45 Stacking Type/ DIN Rail Mounted Individual Wiring	P.536
	Type 45-^A_{NA} Stacking Type/ DIN Rail Mounted Connector Box	P.548
	Type 45S6A Stacking Type/ DIN Rail Mounted EX510 Gateway-type	P.556
	Type 45□ Stacking Type/ DIN Rail Mounted Plug-in	P.564
	Type 45S6B Stacking Type/ DIN Rail Mounted EX510 Gateway-type	P.604

Manifold Option	P.609
SY300/500 3 Port Valve: Mixed Mounting Type on Manifold	P.610

Made to Order

External Pilot/Built-in Silencer	P.616
Mixed Mounting Type	P.621
M8 Connector Conforming to IEC60947-5-2	P.623
Body Ported External Pilot/Fluororubber for Main Valve	P.624
Body Ported Vacuum Release Valve with Throttle Valve	P.625
Pilot Valve Assembly/Port Block Assembly	P.629

Conforming to UL standard

30-SY3000/5000/7000/9000: 5 Port Solenoid Valve Body Ported/Single Unit	P.630
30-SY3000/5000/7000/9000: 5 Port Solenoid Valve Base Mounted/Single Unit	P.631
30-SY300/500: 3 Port Solenoid Valve Body Ported/Single Unit	P.632
30-SY300/500: 3 Port Solenoid Valve Base Mounted/Single Unit	P.633

Specific Product Precautions	P.635
---	-------

SJ
SY
SY
S0700
S0700

5 Port Solenoid Valve Body Ported/Single Unit



[Option]
Note) AC-type models that are CE-compliant have DIN terminals only.

SY3000/5000/7000/9000 Series

How to Order

SY 5 1 20 - 5 L - 01 - - - - -

Series

3	SY3000
5	SY5000
7	SY7000
9	SY9000

Type of actuation

1	2 position single (A) 4 2 (B)	
	(EA) 5 1 3 (EB) (P)	
2	2 position double (A) 4 2 (B)	
	(EA) 5 1 3 (EB) (P)	
3	3 position closed center (A) 4 2 (B)	
	(EA) 5 1 3 (EB) (P)	
4	3 position exhaust center (A) 4 2 (B)	
	(EA) 5 1 3 (EB) (P)	
5	3 position pressure center (A) 4 2 (B)	
	(EA) 5 1 3 (EB) (P)	

Note) For details about Symbol of the 3 position type of the SY9000 series, refer to page 407.

Coil specifications

	Standard
T	With power saving circuit (24, 12 VDC only)

* Power saving circuit is not available in the case of D, DO, Y, YO or W□ type.

For DC

5	24 VDC
6	12 VDC
V	6 VDC
S	5 VDC
R	3 VDC

Rated voltage

For AC (50/60 Hz)	
1	100 VAC
2	200 VAC
3	110 VAC [115 VAC]
4	220 VAC [230 VAC]

* DC specifications of type D, Y, DO and YO is only available with 12 and 24 VDC.

* For type W□, DC voltage is only available. Note) AC-type models that are CE-compliant have DIN terminals only.

Electrical entry

	24, 12, 6, 5, 3 VDC/100, 110, 200, 220 VAC	24, 12 VDC/100, 110, 200, 220 VAC
Grommet	L plug connector	M plug connector
G : Lead wire length 300 mm	L : With lead wire (Length 300 mm)	M : With lead wire (Length 300 mm)
H : Lead wire length 600 mm	LN : Without lead wire	MN : Without lead wire
W□ : With connector cable	LO : Without connector	MO : Without connector
W□ : With connector cable	DO, YO : Without connector	DO, YO : Without connector
CE-compliant	DC	AC
DC	●	●
AC	—	●

- * LN, MN type: with 2 sockets.
- * For DIN terminal of SY3000 series, refer to page 639.
- * "Y" type is a DIN terminal conforming to EN-175301-803C (former DIN43650C). For details, refer to page 638.
- * For connector cable of M8 connector, refer to page 641.
- * M8 connector conforming to IEC60947-5-2 standard is also available. Refer to page 623 for details.
- * Refer to page 638 for the lead wire length of L and M plug connectors.
- * Refer to page 639 for the connector assembly with cover for L and M plug connectors.

Note) Enter the cable length symbols in □. Please be sure to fill in the blank referring to page 642.

A, B port size

Thread piping

Symbol	Port size	Applicable series
M5	M5 x 0.8	SY3000
01	1/8	SY5000
02	1/4	SY7000
02	1/4	SY9000
03	3/8	SY9000

One-touch fitting (Metric size)

Symbol	Port size	Applicable series
C4	One-touch fitting for ø4	SY3000
C6	One-touch fitting for ø6	SY3000
C4	One-touch fitting for ø4	SY5000
C6	One-touch fitting for ø6	SY5000
C8	One-touch fitting for ø8	SY5000
C8	One-touch fitting for ø8	SY7000
C10	One-touch fitting for ø10	SY7000
C8	One-touch fitting for ø8	SY9000
C10	One-touch fitting for ø10	SY9000
C12	One-touch fitting for ø12	SY9000

One-touch fitting (Inch size)

Symbol	Port size	Applicable series
N3	One-touch fitting for ø 3/32	SY3000
N7	One-touch fitting for ø 1/4"	SY3000
N3	One-touch fitting for ø 3/32	SY5000
N7	One-touch fitting for ø 1/4"	SY5000
N9	One-touch fitting for ø 5/16	SY5000
N9	One-touch fitting for ø 5/16	SY7000
N11	One-touch fitting for ø 3/8"	SY7000
N9	One-touch fitting for ø 5/16	SY9000
N11	One-touch fitting for ø 3/8"	SY9000

Manual override

Nil: Non-locking push type



D: Push-turn locking slotted type



E: Push-turn locking lever type



Light/Surge voltage suppressor

Electrical entry for G, H, L, M, W

Symbol	Without light/surge voltage suppressor
Nil	Without light/surge voltage suppressor
S	With surge voltage suppressor
Z	With light/surge voltage suppressor
R	With surge voltage suppressor (Non-polar type)
U	With light/surge voltage suppressor (Non-polar type)

- * For AC voltage valves there is no "S" option. It is already built-in to the rectifier circuit.
- * For "R" and "U", DC voltage is only available.
- * Power saving circuit is only available in the "Z" type.

Electrical entry for D, Y

Symbol	Without light/surge voltage suppressor
Nil	Without light/surge voltage suppressor
S	With surge voltage suppressor (Non-polar type)
Z	With light/surge voltage suppressor (Non-polar type)

- * DOZ and YOZ are not available.
- * For AC voltage valves there is no "S" option. It is already built-in to the rectifier circuit.

Note) When placing an order for body ported solenoid valve as a single unit, mounting screw for manifold and gasket are not attached. Order them separately, if necessary. (For details, refer to page 467.)

Bracket

Nil: Without bracket
F1: With foot bracket

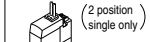

F2: With side bracket

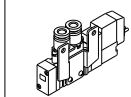

* SY9000 has no bracket.

Thread type

Nil	Rc
F	G
N	NPT
T	NPTF

* Except for M5

Made to Order

Nil	—
X20	Body ported external pilot (Refer to page B24).
X90	Main valve fluororubber (Refer to page B24).

CE-compliant

Nil	—
Q	CE-compliant

Note) AC-type models that are CE-compliant have DIN terminals only.

Body Ported SY3000/5000/7000/9000 Series

Specifications

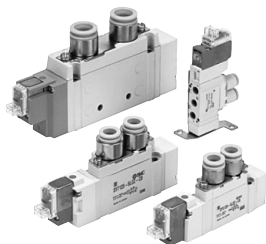

Series		SY3000	SY5000	SY7000	SY9000
Fluid		Air			
Internal pilot	2 position single	0.15 to 0.7			
Operating pressure range (MPa)	2 position double	0.1 to 0.7			
	3 position	0.2 to 0.7			
Ambient and fluid temperature (°C)		-10 to 50 (No freezing)			
Max. operating frequency (Hz)	2 position single, double	10	5	5	5
	3 position	3	3	3	3
Manual override (Manual operation)		Non-locking push type, Push-turn locking slotted type, Push-turn locking lever type			
Pilot exhaust method		Common exhaust type for main and pilot valve			
Lubrication		Not required			
Mounting orientation		Unrestricted			
Impact/Vibration resistance (m/s ²) ^{Note)}		150/30			
Enclosure		Dust proof (* DIN terminal and M8 connector: IP65)			

* Based on IEC60529

Note) Impact resistance: No malfunction occurred when it is tested in the axial direction and at the right angles to the main valve and armature in both energized and de-energized states every once for each condition. (Values at the initial period)

Vibration resistance: No malfunction occurred in a one-sweep test between 45 and 2000 Hz. Test was performed at both energized and de-energized states in the axial direction and at the right angles to the main valve and armature. (Values at the initial period)



Made to Order

(For details, refer to pages 616 to 628.)

Solenoid Specifications

Electrical entry		Grommet (G), (H) L plug connector (L) M plug connector (M)	DIN terminal (D), (Y) M8 connector (W)
		G, H, L, M, W	D, Y
Coil rated voltage (V)	DC	24, 12, 6, 5, 3	24, 12
	AC 50/60 Hz	100, 110, 200, 220	
Allowable voltage fluctuation		±10% of rated voltage *	
Power consumption (W)	DC	0.35 (With indicator light: 0.4 DIN terminal with indicator light: 0.45)	
	Standard	0.1 (With indicator light only) * [Starting 0.4, Holding 0.1]	
Apparent power (VA) *	AC	100 V	0.78 (With indicator light: 0.81) 0.78 (With indicator light: 0.87)
		110 V	0.86 (With indicator light: 0.89) 0.86 (With indicator light: 0.97)
		[115 V]	[0.94 (With indicator light: 0.97)] [0.94 (With indicator light: 1.07)]
		200 V	1.18 (With indicator light: 1.22) 1.15 (With indicator light: 1.30)
		220 V	1.30 (With indicator light: 1.34) 1.27 (With indicator light: 1.46)
	[230 V]	[1.42 (With indicator light: 1.46)] [1.39 (With indicator light: 1.60)]	
Surge voltage suppressor		Diode (Varistor is for DIN terminal and Non-polar type.)	
Indicator light		LED (AC of DIN connector is neon light.)	

* In common between 110 VAC and 115 VAC, and between 220 VAC and 230 VAC.

* For 115 VAC and 230 VAC, the allowable voltage is -15% to +5% of rated voltage.

* DIN terminal and M8 connector with power saving circuit are not available.

* For details, refer to page 636.

Response Time

Note) Based on dynamic performance test, JIS B 8419: 2010. (Coil temperature: 20°C, at rated voltage)

SY3000

Type of actuation	Response time (ms) (at the pressure of 0.5 MPa)		
	Without light/surge voltage suppressor	With light/surge voltage suppressor	
		Type S, Z	Type R, U
2 position single	12 or less	15 or less	12 or less
2 position double	10 or less	13 or less	10 or less
3 position	15 or less	20 or less	16 or less

SY5000

Type of actuation	Response time (ms) (at the pressure of 0.5 MPa)		
	Without light/surge voltage suppressor	With light/surge voltage suppressor	
		Type S, Z	Type R, U
2 position single	19 or less	26 or less	19 or less
2 position double	18 or less	22 or less	18 or less
3 position	32 or less	38 or less	32 or less

SY7000

Type of actuation	Response time (ms) (at the pressure of 0.5 MPa)		
	Without light/surge voltage suppressor	With light/surge voltage suppressor	
		Type S, Z	Type R, U
2 position single	31 or less	38 or less	33 or less
2 position double	27 or less	30 or less	28 or less
3 position	50 or less	56 or less	50 or less

SY9000

Type of actuation	Response time (ms) (at the pressure of 0.5 MPa)		
	Without light/surge voltage suppressor	With light/surge voltage suppressor	
		Type S, Z	Type R, U
2 position single	35 or less	41 or less	35 or less
2 position double	35 or less	41 or less	35 or less
3 position	62 or less	64 or less	62 or less

SY3000/5000/7000/9000 Series

Flow Rate Characteristics/Weight

SY3000 series

Valve model	Type of actuation	Port size		Flow rate characteristics						Weight (g)		
		1, 5, 3 (P, EA, EB)	4, 2 (A, B)	1→4/2 (P→A/B)		4/2→5/3 (AB→EA/EB)		Gro- mmet	L/M plug connector	W M8 connector		
				C (dm ³ /s-bar)	b	Cv	C (dm ³ /s-bar)	b	Cv			
SY3020 -□-M5	2 position	M5 x 0.8		0.61	0.44	0.16	0.64	0.45	0.18	51	53	57
	Double									68	74	82
	Closed center									71	76	84
	3 position											
SY3020 -□-C4	2 position	M5 x 0.8	C4 (One-touch fitting for ø4)	0.72	0.29	0.18	0.64	0.34	0.17	60	63	67
	Double									78	83	91
	Closed center									81	86	94
	3 position											
SY3020 -□-C6	2 position	M5 x 0.8	C6 (One-touch fitting for ø6)	0.76	0.30	0.19	0.65	0.39	0.17	56	59	63
	Double									74	79	87
	Closed center									77	82	90
	3 position											

Note) []: denotes normal position.

SY7000 series

Valve model	Type of actuation	Port size		Flow rate characteristics						Weight (g)		
		1, 5, 3 (P, EA, EB)	4, 2 (A, B)	1→4/2 (P→A/B)		4/2→5/3 (AB→EA/EB)		Gro- mmet	L/M plug connector	DIN terminal	W M8 connector	
				C (dm ³ /s-bar)	b	Cv	C (dm ³ /s-bar)	b	Cv			
SY7020 -□-02	2 position	1/4		4.1	0.23	0.93	3.3	0.33	0.81	101	104	125
	Double									120	125	167
	Closed center									128	133	175
	3 position											
SY7020 -□-C8	2 position	1/4	C8 (One-touch fitting for ø8)	3.2	0.26	0.77	3.2	0.37	0.82	107	110	131
	Double									126	132	174
	Closed center									134	140	182
	3 position											
SY7020 -□-C10	2 position	1/4	C10 (One-touch fitting for ø10)	3.8	0.26	0.86	3.2	0.34	0.82	103	105	126
	Double									122	127	169
	Closed center									130	135	177
	3 position											

Note) []: denotes normal position.

SY5000 series

Valve model	Type of actuation	Port size		Flow rate characteristics						Weight (g)		
		1, 5, 3 (P, EA, EB)	4, 2 (A, B)	1→4/2 (P→A/B)		4/2→5/3 (AB→EA/EB)		Gro- mmet	L/M plug connector	DIN terminal	W M8 connector	
				C (dm ³ /s-bar)	b	Cv	C (dm ³ /s-bar)	b	Cv			
SY5020 -□-01	2 position	1/8		1.9	0.35	0.49	2.4	0.39	0.61	70	72	93
	Double									88	93	135
	Closed center									93	98	140
	3 position											
SY5020 -□-C4	2 position	1/8	C4 (One-touch fitting for ø4)	0.75	0.43	0.20	0.85	0.64	0.30	94	96	117
	Double									111	117	159
	Closed center									117	122	164
	3 position											
SY5020 -□-C6	2 position	1/8	C6 (One-touch fitting for ø6)	1.5	0.33	0.33	2.0	0.37	0.52	88	91	112
	Double									106	111	153
	Closed center									111	116	158
	3 position											
SY5020 -□-C8	2 position	1/8	C8 (One-touch fitting for ø8)	1.9	0.21	0.45	2.3	0.29	0.57	80	82	103
	Double									98	103	145
	Closed center									103	108	150
	3 position											

Note) []: denotes normal position.

SY9000 series

Valve model	Type of actuation	Port size		Flow rate characteristics						Weight (g)		
		1, 5, 3 (P, EA, EB)	4, 2 (A, B)	1→4/2 (P→A/B)		4/2→5/3 (AB→EA/EB)		Gro- mmet	L/M plug connector	DIN terminal	W M8 connector	
				C (dm ³ /s-bar)	b	Cv	C (dm ³ /s-bar)	b	Cv			
SY9020 -□-02	2 position	1/4		7.0	0.33	1.7	7.6	0.35	2.0	241	244	265
	Double									260	266	308
	Closed center									284	290	332
	3 position											
SY9020 -□-03	2 position	3/8		8.0	0.29	1.9	8.0	0.33	2.0	236	239	260
	Double									255	261	303
	Closed center									279	285	327
	3 position											
SY9020 -□-C8	2 position	1/4	C8 (One-touch fitting for ø8)	4.3	0.31	0.99	6.1	0.28	1.4	293	296	317
	Double									312	318	360
	Closed center									336	342	384
	3 position											
SY9020 -□-C10	2 position	1/4	C10 (One-touch fitting for ø10)	6.1	0.28	1.4	7.9	0.33	1.9	279	282	303
	Double									298	304	346
	Closed center									322	328	370
	3 position											
SY9020 -□-C12	2 position	1/2	C12 (One-touch fitting for ø12)	7.0	0.25	1.6	8.6	0.41	2.2	265	268	289
	Double									284	290	332
	Closed center									308	314	356
	3 position											

Note) []: denotes normal position.

Construction

SY series

Symbol 2 position single

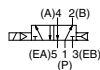

Symbol 2 position double

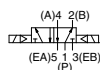

Symbol 3 position closed center

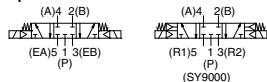

3 position exhaust center

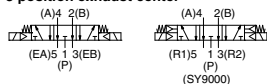

3 position pressure center

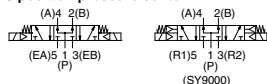

2 position single

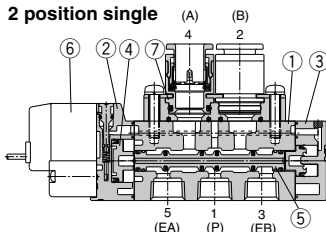

2 position double

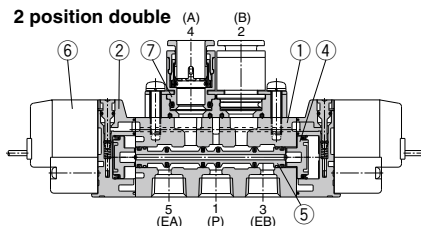

3 position closed center / exhaust center / pressure center

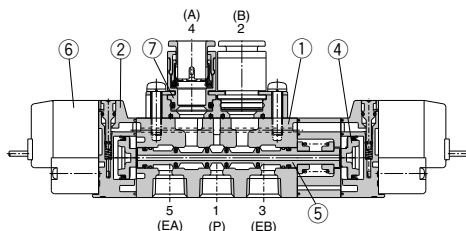

(This figure shows a closed center type.)

Component Parts

No.	Description	Material	Note
1	Body	Aluminum die-casted (SY3000: Zinc die-casted)	White
2	Adapter plate	Resin	White (SY9000: Gray)
3	End plate	Resin	White
4	Piston	Resin	—
5	Spool valve assembly	Aluminum, H-NBR	—

Replacement Parts

No.	Description	Part no.
6	Pilot valve assembly	Refer to "How to Order Pilot Valve Assembly" on page 629.
7	M5 port block assembly	Refer to "How to Order Port Block Assembly" on page 629.

Bracket Assembly No.

Description	Part no.
Bracket (For F1)	SX000-16-2A (with mounting screw)
Bracket (For F2)	SX000-16-1A (with mounting screw)

* SY9000 has no bracket.

SJ
SY
SY
S0700
S0700

How to Change Port Block Assembly

If using body port type, both A and B port sizes can be changed by replacing the port block assembly mounted on the body. When changing this block assembly, the correct screw torque must be achieved to avoid possible air leakage.

For SY5000

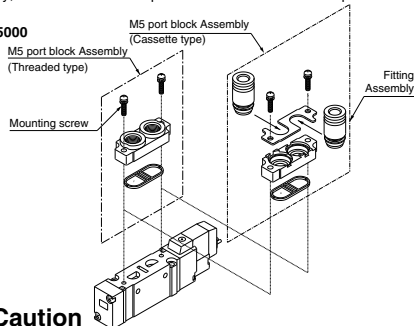

Caution

Mounting screw tightening torques

SY3000 (M2): 0.12 N·m
 SY5000 (M3): 0.6 N·m
 SY9000 (M4): 1.4 N·m

* Refer to "How to Order Port Block Assembly" on page 629 for part no.

SY3000/5000/7000/9000 Series

Dimensions: SY3000 Series

[] : AC

2 position single

Grommet (G), (H): SY3120-□_G□□-C₄, N₃
C₆, N₇(-F₂)

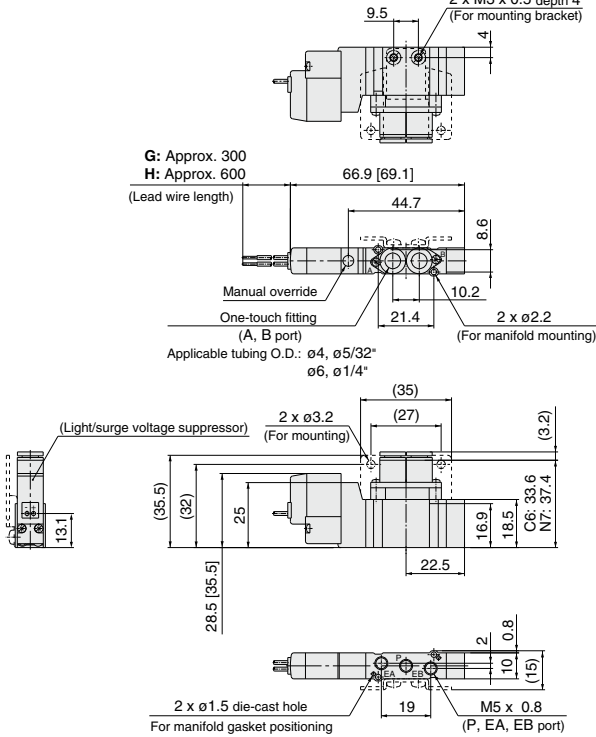

Foot bracket

SY3120-□_G□□-C₄, N₃
C₆, N₇-F₁

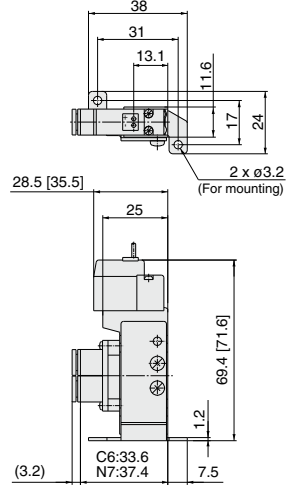

SY3120-□_G□□-M5(-F₂)

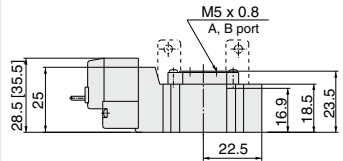

L plug connector (L):

SY3120-□L□□-C₄, N₃
C₆, N₇(-F₂)

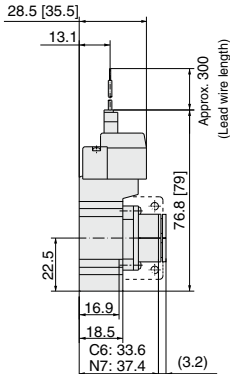

M plug connector (M):

SY3120-□M□□-C₄, N₃
C₆, N₇(-F₂)

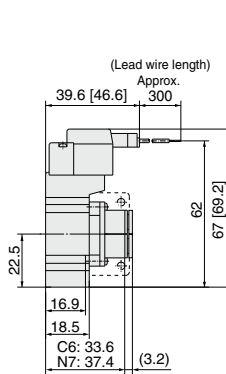

M8 connector (WO):

SY3120-□WO□□-C₄, N₃
C₆, N₇(-F₂)

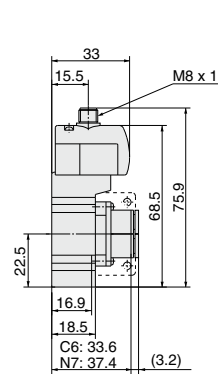

Note) Refer to page 642 for dimensions of connector types.

Dimensions: SY3000 Series

[] : AC

2 position double

Grommet (G), (H): SY3220-□^G□□-C4, N3
C6, N7(-F2)

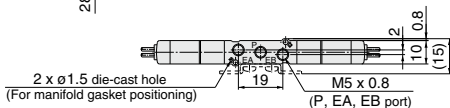
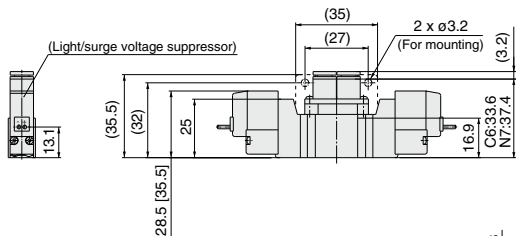
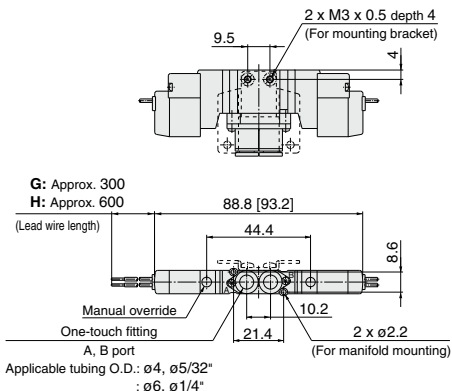

SY3220-□^G□□-M5(-F2)

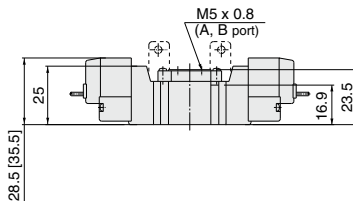

SJ

SY

SY

S0700

S0700

L plug connector (L):
SY3220-□L□□-C4, N3
C6, N7(-F2)

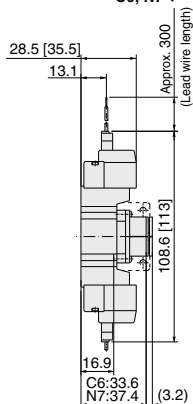

M plug connector (M):
SY3220-□M□□-C4, N3
C6, N7(-F2)

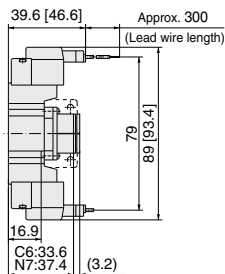

M8 connector (WO):
SY3220-WO□□-C4, N3
C6, N7(-F2)

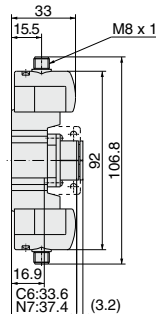

Note) Refer to page 642 for dimensions of connector types.

SY3000/5000/7000/9000 Series

Dimensions: SY3000 Series

[]: AC

3 position closed center / exhaust center / pressure center

Grommet (G), (H): SY3 $\frac{3}{8}$ 20-□G□□-C4, N3
C6, N7 (-F2)

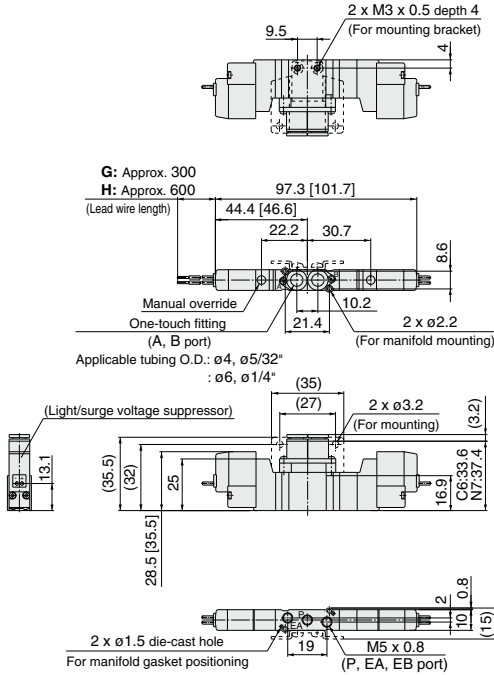

SY3 $\frac{3}{8}$ 20-□H□□-M5(-F2)

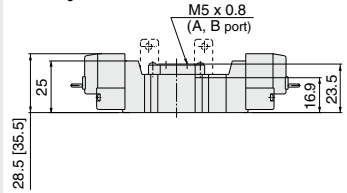

L plug connector (L):

SY3 $\frac{3}{8}$ 20-□L□□-C4, N3
C6, N7 (-F2)

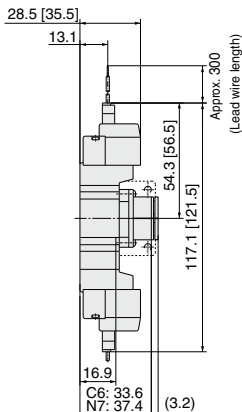

M plug connector (M):

SY3 $\frac{3}{8}$ 20-□M□□-C4, N3
C6, N7 (-F2)

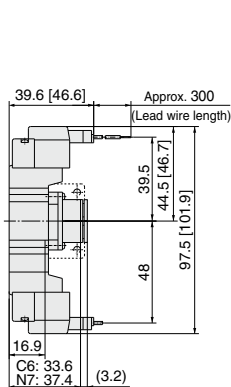

M8 connector (WO):

SY3 $\frac{3}{8}$ 20-□WO□□-C4, N3
C6, N7 (-F2)

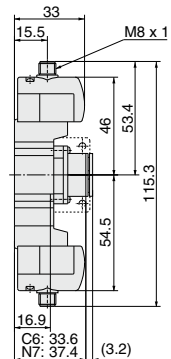

Note) Refer to page 642 for dimensions of connector types.

Body Ported SY3000/5000/7000/9000 Series

Dimensions: SY5000 Series

[] : AC

2 position single

Grommet (G), (H): SY5120-□^G□^H□^{C4, N3}□^{C6, N7}□^{C8, N9}(-F₂)

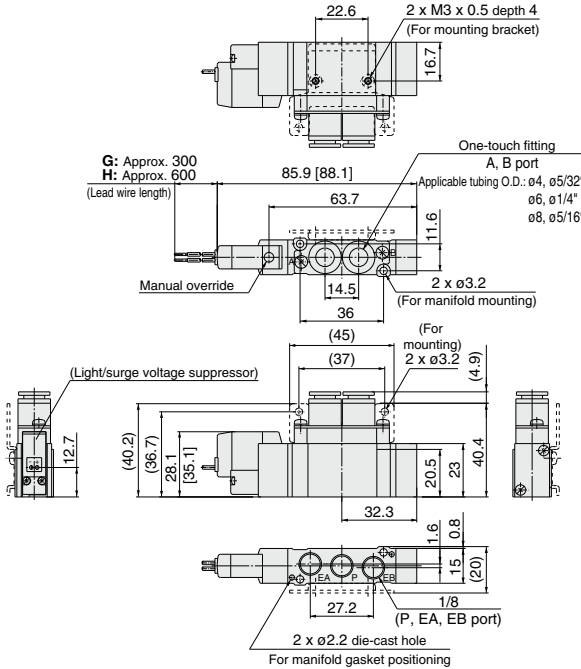

Foot bracket

SY5120-□^G□^H□^{C4, N3}□^{C6, N7}□^{C8, N9}(-F₁)

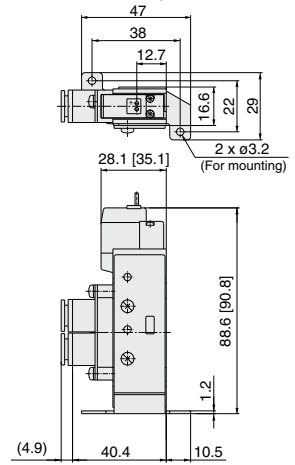

SY5120-□^G□^H□^{C4, N3}□^{C6, N7}□^{C8, N9}(-F₂)

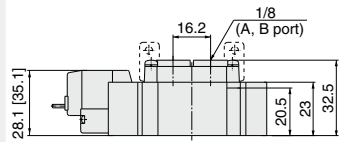

L plug connector (L):

SY5120-□^L□^{C4, N3}□^{C6, N7}□^{C8, N9}(-F₂)

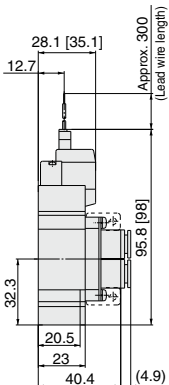

M plug connector (M):

SY5120-□^M□^{C4, N3}□^{C6, N7}□^{C8, N9}(-F₂)

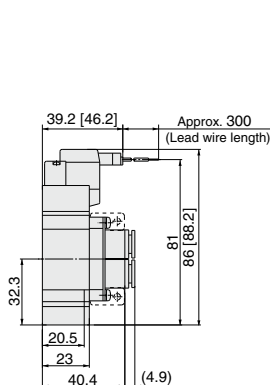

DIN terminal (D, Y):

SY5120-□^{D, Y}□^{C4, N3}□^{C6, N7}□^{C8, N9}(-F₂)

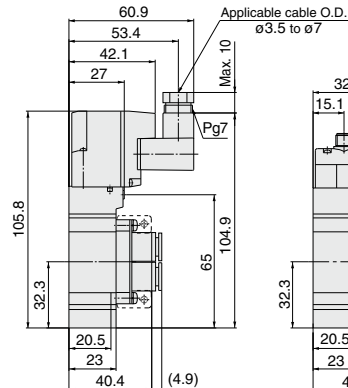

M8 connector (WO):

SY5120-□^{WO}□^{C4, N3}□^{C6, N7}□^{C8, N9}(-F₂)

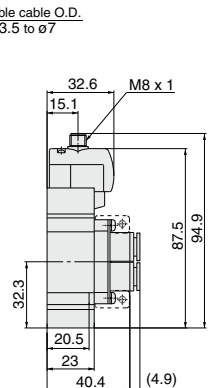

Note) Refer to page 642 for dimensions of connector types.

SY3000/5000/7000/9000 Series

Dimensions: SY5000 Series

[]: AC

2 position double

Grommet (G), (H): SY5220-□^G□^H□^{C4, N3}□^{C6, N7}□^{C8, N9}□(-F2)

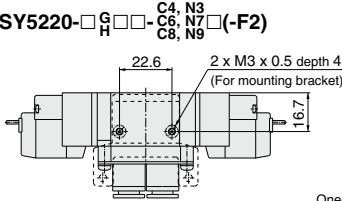

SY5220-□^G□^H□^{C4, N3}□^{C6, N7}□^{C8, N9}-01□(-F2)

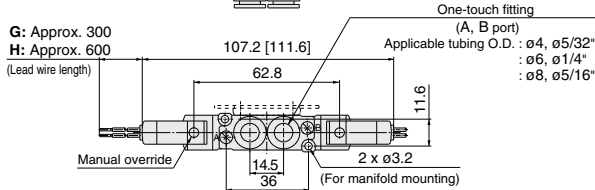
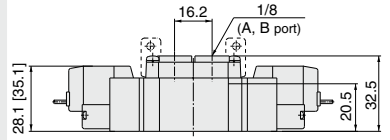

One-touch fitting

(A, B port)

Applicable tubing O.D.: ø4, ø5/32"

: ø6, ø1/4"

: ø8, ø5/16"

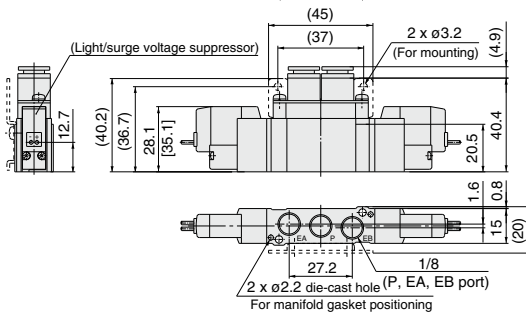

L plug connector (L):

SY5220-□^L□^{C4, N3}□^{C6, N7}□^{C8, N9}□(-F2)

M plug connector (M):

SY5220-□^M□^{C4, N3}□^{C6, N7}□^{C8, N9}□(-F2)

DIN terminal (D, Y):

SY5220-□^{D, Y}□^{C4, N3}□^{C6, N7}□^{C8, N9}□(-F2)

M8 connector (WO):

SY5220-□^{WO}□^{C4, N3}□^{C6, N7}□^{C8, N9}□(-F2)

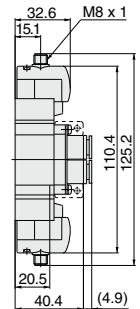
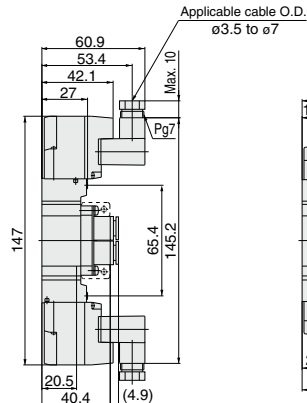
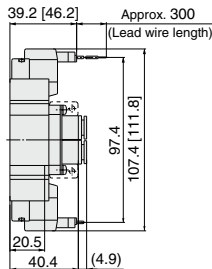
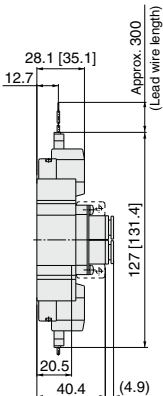

Note) Refer to page 642 for dimensions of connector types.

SY3000/5000/7000/9000 Series

Dimensions: SY7000 Series

[] : AC

2 position single

Grommet (G), (H): SY7120-□G□□-C8, N9□□(-F2)
C10, N11□□(-F2)

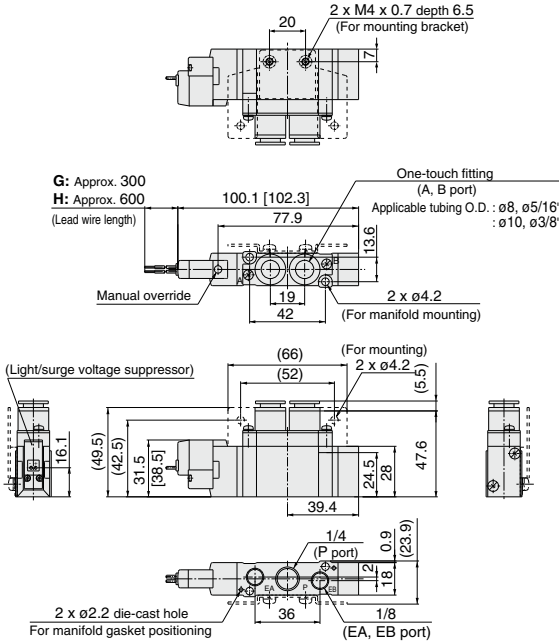

SY7120-□G□□-C8, N9□□(-F1)
C10, N11□□(-F1)

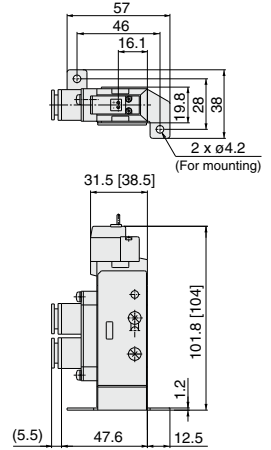

SY7120-□G□□-02□(-F2)

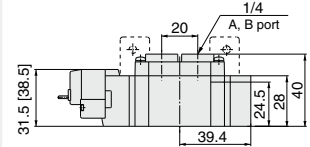

L plug connector (L):

SY7120-□L□□-C8, N9□□(-F2)
C10, N11□□(-F2)

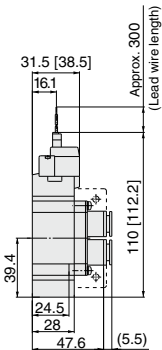

M plug connector (M):

SY7120-□M□□-C8, N9□□(-F2)
C10, N11□□(-F2)

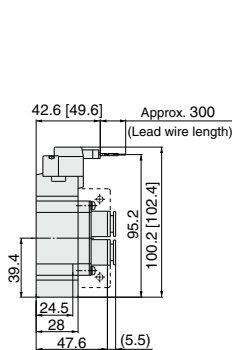

DIN terminal (D, Y):

SY7120-□D□□-C8, N9□□(-F2)
C10, N11□□(-F2)

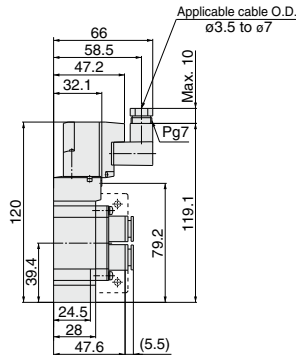

M8 connector (WO):

SY7120-□WO□□-C8, N9□□(-F2)
C10, N11□□(-F2)

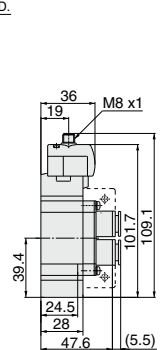

(Note) Refer to page 642 for dimensions of connector types.

Dimensions: SY7000 Series

[]: AC

2 position double

Grommet (G), (H): SY7220-□G□□-C8, N9 C10, N11 □(-F2)

SY7220-□G□□-02□(-F2)

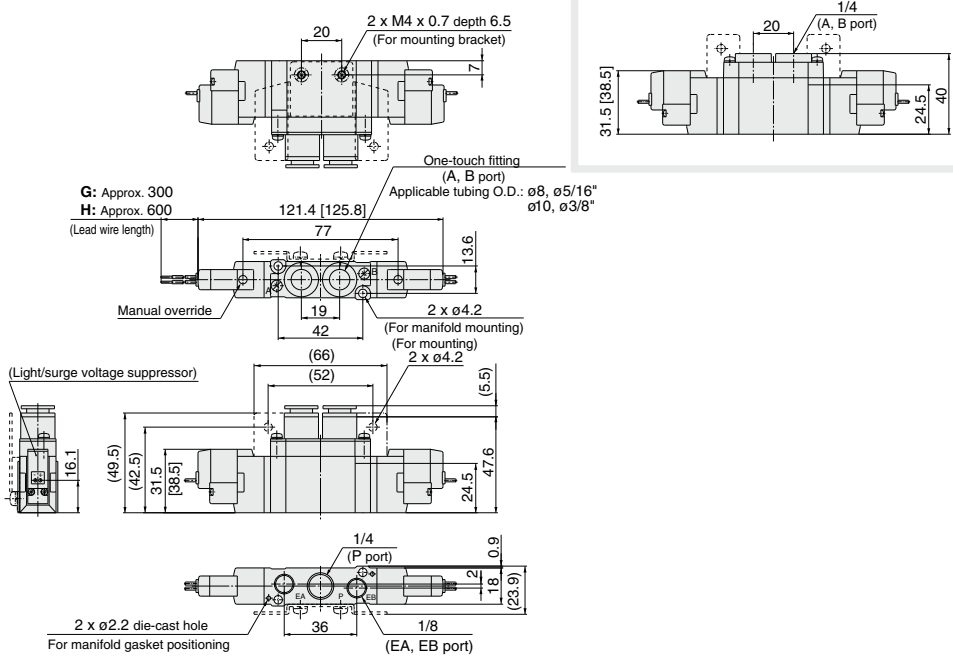

SJ
SY
SY
S0700
S0700

L plug connector (L):

SY7220-□L□□-C8, N9 C10, N11 □(-F2)

M plug connector (M):

SY7220-□M□□-C8, N9 C10, N11 □(-F2)

DIN terminal (D, Y):

SY7220-□D□□-C8, N9 C10, N11 □(-F2)

M8 connector (WO):

SY7220-□WO□□-C8, N9 C10, N11 □(-F2)

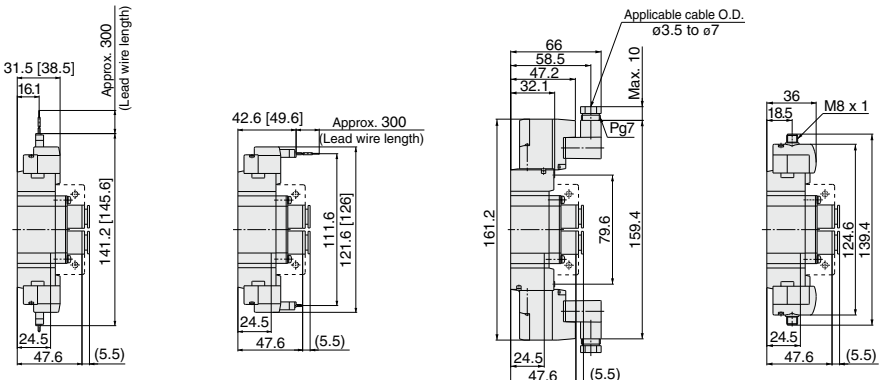

Note) Refer to page 642 for dimensions of connector types.

SY3000/5000/7000/9000 Series

Dimensions: SY7000 Series

[] : AC

3 position closed center / exhaust center / pressure center

Grommet (G), (H): SY7 $\frac{3}{5}$ 20-□□□□-C8, N9
C10, N11 □□(-F2)

SY7 $\frac{3}{5}$ 20-□□□□-02□(-F2)

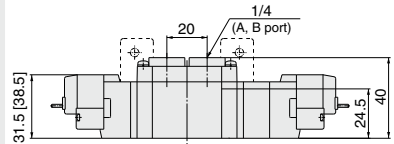
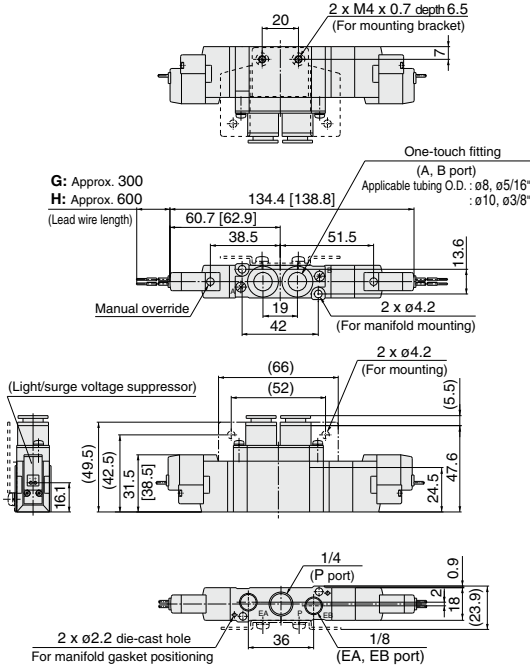

L plug connector (L):

M plug connector (M):

DIN terminal (D, Y):

M8 connector (WO):

SY7 $\frac{3}{5}$ 20-□□□□-C8, N9
C10, N11 □□(-F2)

SY7 $\frac{3}{5}$ 20-□□□□-C8, N9
C10, N11 □□(-F2)

SY7 $\frac{3}{5}$ 20-□□□□-C8, N9
C10, N11 □□(-F2)

SY7 $\frac{3}{5}$ 20-□□□□-C8, N9
C10, N11 □□(-F2)

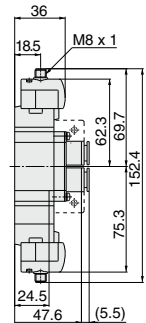
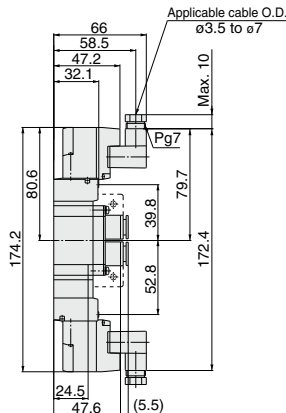
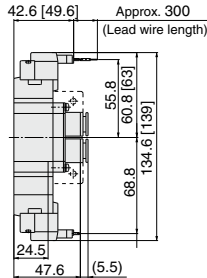
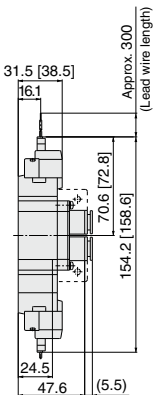

Note) Refer to page 642 for dimensions of connector types.

Body Ported SY3000/5000/7000/9000 Series

Dimensions: SY9000 Series

[JAC

2 position single

Grommet (G), (H): SY9120-□G□□□C8, N9
C12

SY9120-□G□□□02□□

G: Approx. 300
H: Approx. 600
(Lead wire length)

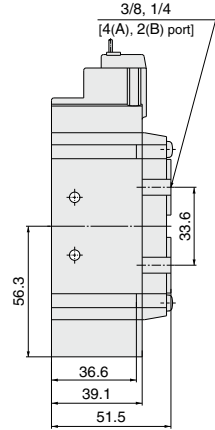
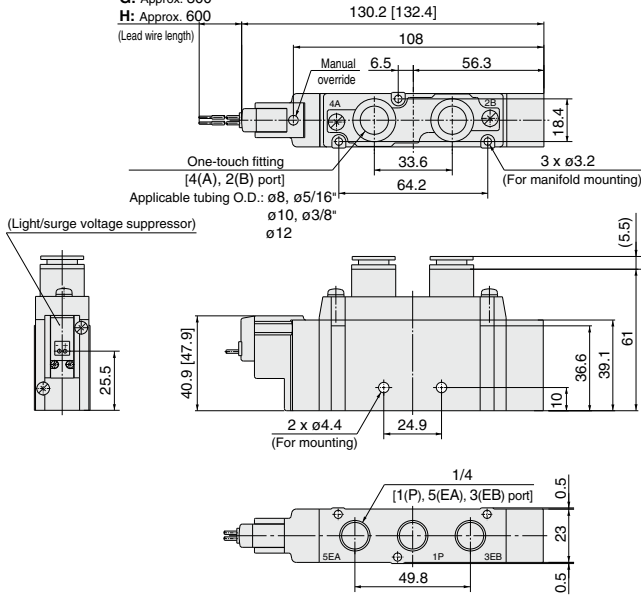

L plug connector (L):
SY9120-□L□□□C8, N9
C12, N11

M plug connector (M):
SY9120-□M□□□C8, N9
C12, N11

DIN terminal (D, Y):
SY9120-□D□□□C8, N9
C12, N11

M8 connector (WO):
SY9120-□WO□□□C8, N9
C12, N11

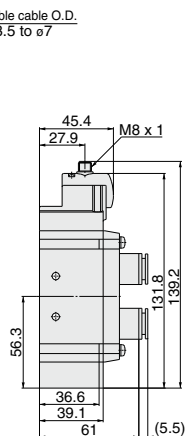
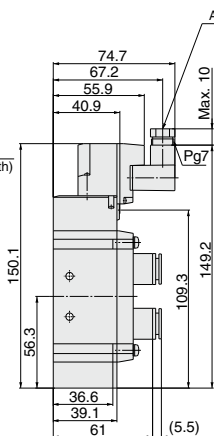
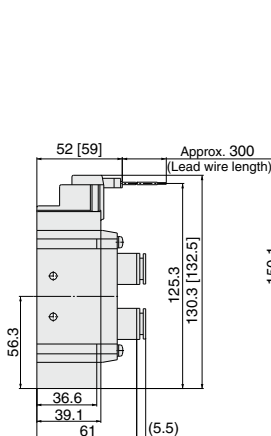
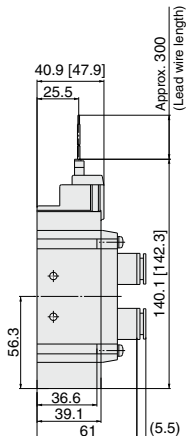

Note) Refer to page 642 for dimensions of connector types.

SY3000/5000/7000/9000 Series

Dimensions: SY9000 Series

[] : AC

2 position double

Grommet (G), (H): SY9220-□^G□^H□^{C8, N9}□^{C10, N11}□^{C12}

G: Approx. 300
H: Approx. 600

SY9220-□^G□^H□^{C8, N9}□^{C10, N11}□^{C12}

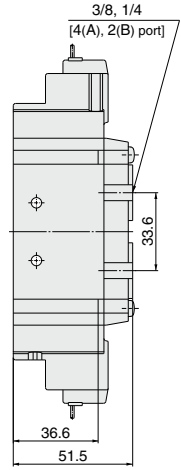
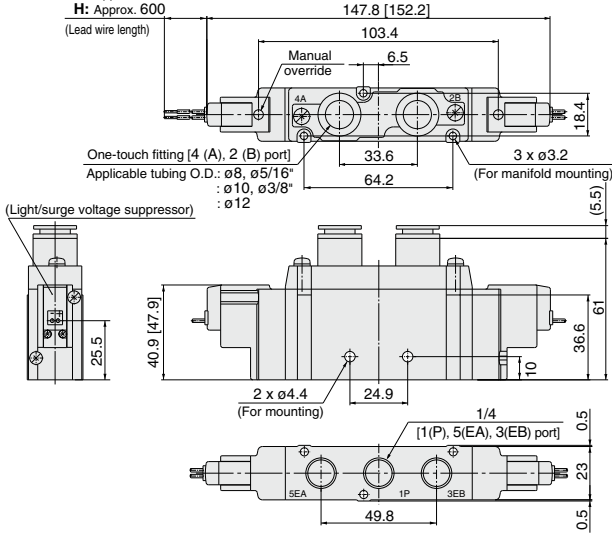

L plug connector (L):
SY9220-□^L□^{C8, N9}□^{C10, N11}□^{C12}

M plug connector (M):
SY9220-□^M□^{C8, N9}□^{C10, N11}□^{C12}

DIN terminal (D, Y):
SY9220-□^{D, Y}□^{C8, N9}□^{C10, N11}□^{C12}

M8 connector (WO):
SY9220-□^{WO}□^{C8, N9}□^{C10, N11}□^{C12}

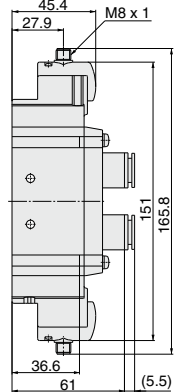
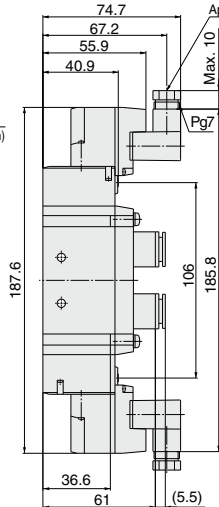
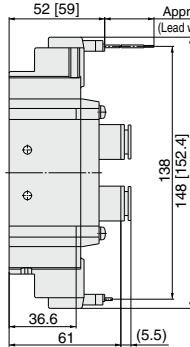
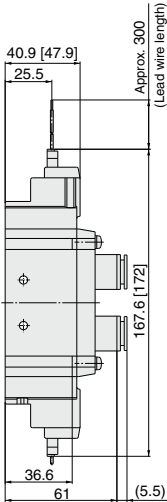

Note) Refer to page 642 for dimensions of connector types.

Dimensions: SY9000 Series

[]: AC

3 position closed center / exhaust center / pressure center

Grommet (G), (H): SY9³/₅20-□^G□□-^{C8, N9}□□-^{C10, N11}□□^{C12}

G: Approx. 300
H: Approx. 600
(Lead wire length)

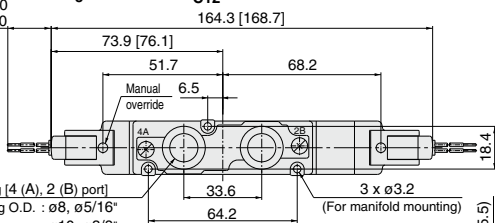

One-touch fitting 4 (A), 2 (B) port

Applicable tubing O.D.: ø8, ø5/16"
: ø10, ø3/8"
: ø12

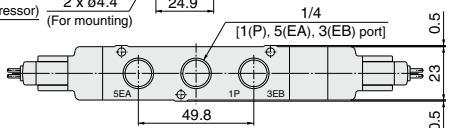
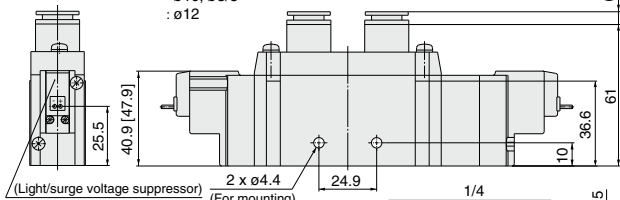

SY9³/₅20-□^G□□-^{C8, N9}□□-^{C10, N11}□□^{C12}

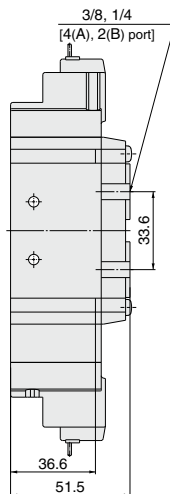

SJ
SY
SY
S0700
S0700

L plug connector (L):

SY9³/₅20-□^L□□-^{C8, N9}□□-^{C10, N11}□□^{C12}

M plug connector (M):

SY9³/₅20-□^M□□-^{C8, N9}□□-^{C10, N11}□□^{C12}

DIN terminal (D, Y):

SY9³/₅20-□^{D, Y}□□-^{C8, N9}□□-^{C10, N11}□□^{C12}

M8 connector (WO):

SY9³/₅20-□^{WO}□□-^{C8, N9}□□-^{C10, N11}□□^{C12}

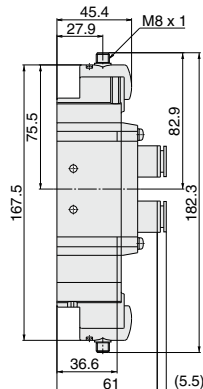
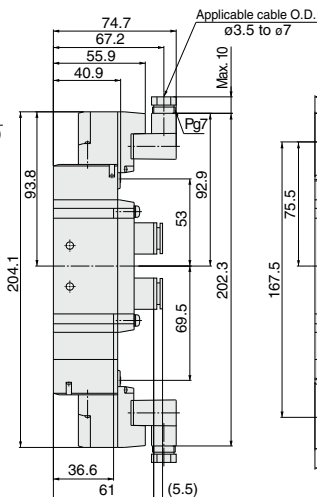
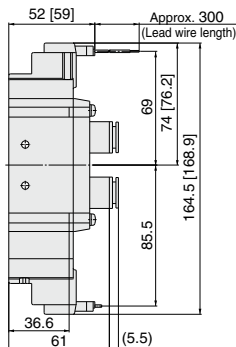
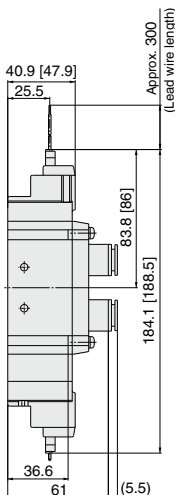

Note) Refer to page 642 for dimensions of connector types.

5 Port Solenoid Valve

Base Mounted/Single Unit

SY3000/5000/7000/9000 Series



[Option]
Note) AC-type models that are CE-compliant have DIN terminals only.

How to Order

SY **5** **2** **40** [] [] - **5** **L** [] [] - [] [] - [] []

Series

3	SY3000
5	SY5000
7	SY7000
9	SY9000

Type of actuation

1	2 position single (A)4 2(B) (EA)5 1 3(EB) (P)
2	2 position double (A)4 2(B) (EA)5 1 3(EB) (P)
3	3 position closed center (A)4 2(B) (EA)5 1 3(EB) (P)
4	3 position exhaust center (A)4 2(B) (EA)5 1 3(EB) (P)
5	3 position pressure center (A)4 2(B) (EA)5 1 3(EB) (P)

Note) For details about Symbol of the 3 position type of SY9000 series, refer to page 423.

Pilot type

Nil	Internal pilot
R	External pilot*

* External pilot specifications for SY3000 DIN terminal are not available.

Coil specifications

Nil	Standard
T	With power saving circuit (24, 12 VDC only)

* Power saving circuit is not available in the case of D, Y, DO, YO or W□ type.

Rated voltage

For DC

5	24 VDC
6	12 VDC
V	6 VDC
S	5 VDC
R	3 VDC

For AC (50/60 Hz)

1	100 VAC
2	200 VAC
3	110 VAC [115 VAC]
4	220 VAC [230 VAC]

* DC specifications of type D, Y, DO and YO is only available with 12 and 24 VDC.
* For type W□, DC voltage is only available.

Port size

Symbol	Port size	Applicable series
Nil	Without sub-plate	
01	1/8 With sub-plate	SY3000
02	1/4 With sub-plate	SY5000 SY7000
03	3/8 With sub-plate	SY7000 SY9000
04	1/2 With sub-plate	SY9000

Thread type

Nil	Rc
F	G
N	NPT
T	NPTF

Made to Order

Nil	—
X90	Main valve fluororubber (Refer to page 624.)

Manual override

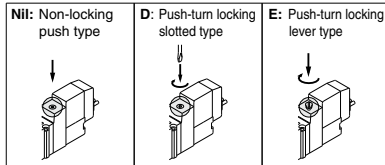

CE-compliant

Nil	—
Q	CE-compliant

Note)
AC-type models that are CE-compliant have DIN terminals only.

Light/Surge voltage suppressor

Electrical entry for G, H, L, M, W

Nil	Without light/surge voltage suppressor
S	With surge voltage suppressor
Z	With light/surge voltage suppressor
R	With surge voltage suppressor (Non-polar type)
U	With light/surge voltage suppressor (Non-polar type)

* For AC voltage valves there is no "S" option. It is already built-in to the rectifier circuit.
* For "R" and "U", DC voltage is only available.
* Power saving circuit is only available in the "Z" type.

Electrical entry for D, Y

Nil	Without light/surge voltage suppressor
S	With surge voltage suppressor (Non-polar type)
Z	With light/surge voltage suppressor (Non-polar type)

* DOZ and YOZ are not available.
* For AC voltage valves there is no "S" option. It is already built-in to the rectifier circuit.

Electrical entry

	24, 12, 6, 5, 3 VDC / 100, 110, 200, 220 VAC	24, 12 VDC / 100, 110, 200, 220 VAC	24, 12, 6, 5, 3 VDC
	Grommet	M plug connector	DIN terminal
	L plug connector	MN: Without lead wire	M8 connector
	G: Lead wire length 300 mm	L: With lead wire (Length 300 mm)	DO, YO: Without connector
	H: Lead wire length 600 mm	LN: Without lead wire	W□: With connector cable (Note)
	LO: Without connector	MO: Without connector	
CE-compliant	DC	AC	

* LN, MN type: with 2 sockets.

* The DIN terminal of SY3000 series cannot be mounted on the standard sub-plate. For details, refer to page 639.

* "Y" type is a DIN terminal conforming to EN-175301-803C (former DIN43650C). For details, refer to page 638.

* For connector cable of M8 connector, refer to page 641.

* M8 connector conforming to IEC60947-5-2 standard is also available. Refer to page 623 for details.

* Refer to page 638 for the lead wire length of L and M plug connectors.

* Refer to page 639 for the connector assembly with cover for L and M plug connectors.

Note) Enter the cable length symbols in □. Please be sure to fill in the blank referring to page 642.

Note) When ordering single unit of the base mounted type solenoid valve, the mounting screws and gaskets for the manifold are included.

Specifications



Made to Order
(For details, refer to pages 616 to 628.)

Series		SY3000	SY5000	SY7000	SY9000
Fluid		Air			
Internal pilot	2 position single	0.15 to 0.7			
	2 position double	0.1 to 0.7			
Operating pressure range (MPa)	3 position	0.2 to 0.7			
	Operating pressure range	-100 kPa to 0.7			
External pilot	Operating pressure range (MPa)	Pilot pressure	0.25 to 0.7		
		2 position single	0.25 to 0.7		
		2 position double	0.25 to 0.7		
	3 position	0.25 to 0.7			
Ambient and fluid temperature (°C)		-10 to 50 (No freezing.)			
Max. operating frequency (Hz)	2 position single, double	10	5	5	5
	3 position	3	3	3	3
Manual override (Manual operation)		Non-locking push type, Push-turn locking slotted type, Push-turn locking lever type			
Pilot exhaust method	Internal pilot	Common exhaust type for main and pilot valve			
	External pilot	Pilot valve individual exhaust			
Lubrication		Not required			
Mounting orientation		Unrestricted			
Impact/Vibration resistance (m/s²) <small>Note</small>		150/30			
Enclosure		Dust proof (* DIN terminal and M8 connector: IP65)			

* Based on IEC60529

Note) Impact resistance: No malfunction occurred when it is tested in the axial direction and at the right angles to the main valve and armature in both energized and de-energized states every once for each condition. (Values at the initial period)

Vibration resistance: No malfunction occurred in a one-sweep test between 45 and 2000 Hz. Test was performed at both energized and de-energized states in the axial direction and at the right angles to the main valve and armature. (Values at the initial period)

SJ

SY

SY

S0700

S0700

Response Time

Note) Based on dynamic performance test, JIS B 8419: 2010. (Coil temperature: 20°C, at rated voltage)

SY3000

Type of actuation	Response time (ms) (at the pressure of 0.5 MPa)		
	Without light/surge voltage suppressor	With light/surge voltage suppressor	
		Type S, Z	Type R, U
2 position single	12 or less	15 or less	12 or less
2 position double	10 or less	13 or less	10 or less
3 position	15 or less	20 or less	16 or less

SY5000

Type of actuation	Response time (ms) (at the pressure of 0.5 MPa)		
	Without light/surge voltage suppressor	With light/surge voltage suppressor	
		Type S, Z	Type R, U
2 position single	19 or less	26 or less	19 or less
2 position double	18 or less	22 or less	18 or less
3 position	32 or less	38 or less	32 or less

SY7000

Type of actuation	Response time (ms) (at the pressure of 0.5 MPa)		
	Without light/surge voltage suppressor	With light/surge voltage suppressor	
		Type S, Z	Type R, U
2 position single	31 or less	38 or less	33 or less
2 position double	27 or less	30 or less	28 or less
3 position	50 or less	56 or less	50 or less

SY9000

Type of actuation	Response time (ms) (at the pressure of 0.5 MPa)		
	Without light/surge voltage suppressor	With light/surge voltage suppressor	
		Type S, Z	Type R, U
2 position single	35 or less	41 or less	35 or less
2 position double	35 or less	41 or less	35 or less
3 position	62 or less	64 or less	62 or less

Solenoid Specifications

Electrical entry		Grommet (G), (H) L plug connector (L) M plug connector (M)		DIN terminal (D), (Y) M8 connector (W)	
		G, H, L, M, W		D, Y	
Coil rated voltage (V)	DC	24, 12, 6, 5, 3			
	AC 50/60 Hz	100, 110, 200, 220			
Allowable voltage fluctuation		±10% of rated voltage *			
Power consumption (W)	DC	Standard	0.35 (With indicator light: 0.4 DIN terminal with indicator light: 0.45)		
		With power saving circuit	0.1 (With indicator light only) * [Starting 0.4, Holding 0.1]		
Apparent power (VA) *	AC	100 V	0.78 (With indicator light: 0.81)	0.78 (With indicator light: 0.87)	
		110 V [115 V]	0.86 (With indicator light: 0.89)	0.86 (With indicator light: 0.97)	
		200 V	1.18 (With indicator light: 1.22)	1.15 (With indicator light: 1.30)	
		220 V [230 V]	1.30 (With indicator light: 1.34)	1.27 (With indicator light: 1.46)	
Surge voltage suppressor		Diode (Varistor is for DIN terminal and Non-polar type.)			
Indicator light		LED (AC of DIN connector is neon light.)			

* In common between 110 VAC and 115 VAC, and between 220 VAC and 230 VAC.

* For 115 VAC and 230 VAC, the allowable voltage is -15% to +5% of rated voltage.

* DIN terminal and M8 connector with power saving circuit are not available.

* For details, refer to page 636.

SY3000/5000/7000/9000 Series

Flow Rate Characteristics/Weight

SY3000 series

Valve model	Type of actuation		Port size	Flow rate characteristics ^{Note 1)}						Weight (g) ^{Note 2)}		
				1 → 4/2 (P → A/B)			4/2 → 5/3 (A/B → EA/EB)			Grommet	L plug connector, M plug connector	W M8 connector
				C (dm ³ /s/bar)	b	Cv	C (dm ³ /s/bar)	b	Cv			
SY3□40-□-01	2 position	Single	1/8	1.0	0.30	0.24	1.1	0.30	0.26	84 (50)	85 (53)	89 (57)
		Double		0.77	0.28	0.18	0.85	0.30	0.19	102 (68)	107 (73)	115 (81)
	Closed center			0.73	0.31	0.18	1.1	0.26	0.24	104 (69)	109 (74)	117 (82)
	Exhaust center			1.2	0.24	0.29	[0.55]	[0.52]	[0.16]			
	Pressure center			[0.51]	[0.45]	[0.14]	0.89	0.47	0.24			

Note 1) []: denotes the normal position. Note 2) (): denotes without sub-plate.

SY5000 series

Valve model	Type of actuation		Port size	Flow rate characteristics ^{Note 1)}						Weight (g) ^{Note 2)}			
				1 → 4/2 (P → A/B)			4/2 → 5/3 (A/B → EA/EB)			Grommet	L plug connector, M plug connector	DIN terminal	W M8 connector
				C (dm ³ /s/bar)	b	Cv	C (dm ³ /s/bar)	b	Cv				
SY5□40-□-02	2 position	Single	1/4	2.4	0.41	0.64	2.8	0.29	0.66	121 (58)	123 (61)	154 (92)	127 (65)
		Double		1.8	0.47	0.50	1.8	0.40	0.47	139 (76)	144 (81)	186 (123)	152 (89)
	Closed center			1.4	0.55	0.44	3.0	0.33	0.72	144 (82)	150 (87)	192 (129)	158 (95)
	Exhaust center			[1.2]	[0.48]	[0.37]	[1.2]	[0.48]	[0.37]				
	Pressure center			3.3	0.36	0.85	1.8	0.40	0.48				

Note 1) []: denotes the normal position. Note 2) (): denotes without sub-plate.

SY7000 series

Valve model	Type of actuation		Port size	Flow rate characteristics ^{Note 1)}						Weight (g) ^{Note 2)}			
				1 → 4/2 (P → A/B)			4/2 → 5/3 (A/B → EA/EB)			Grommet	L plug connector, M plug connector	DIN terminal	W M8 connector
				C (dm ³ /s/bar)	b	Cv	C (dm ³ /s/bar)	b	Cv				
SY7□40-□-02	2 position	Single	1/4	4.1	0.41	1.1	4.1	0.29	1.0	218 (89)	221 (92)	242 (113)	225 (96)
		Double		3.0	0.43	0.80	2.6	0.41	0.72	237 (108)	242 (113)	284 (155)	250 (121)
	Closed center			2.6	0.42	0.71	4.7	0.35	1.1	239 (110)	245 (116)	287 (158)	253 (124)
	Exhaust center			[1.7]	[0.48]	[0.49]	[1.7]	[0.48]	[0.49]				
	Pressure center			5.3	0.39	1.3	2.2	0.49	0.63				
	SY7□40-□-03	2 position		Single	3/8	4.9	0.29	1.2	4.5	0.27	1.1	218 (89)	221 (92)
Double			3.0	0.40		0.80	2.6	0.45	0.73	237 (108)	242 (113)	284 (155)	250 (121)
Closed center		2.6	0.42	0.71		4.8	0.35	1.1	239 (110)	245 (116)	287 (158)	253 (124)	
Exhaust center		[1.7]	[0.48]	[0.49]		[1.7]	[0.48]	[0.49]					
Pressure center		5.3	0.31	1.3		2.3	0.45	0.66					[2.3]

Note 1) []: denotes the normal position. Note 2) (): denotes without sub-plate.

SY9000 series

Valve model	Type of actuation		Port size	Flow rate characteristics ^{Note 1)}						Weight (g) ^{Note 2)}			
				1 → 4/2 (P → A/B)			4/2 → 5/3 (A/B → EA/EB)			Grommet	L plug connector, M plug connector	DIN terminal	W M8 connector
				C (dm ³ /s/bar)	b	Cv	C (dm ³ /s/bar)	b	Cv				
SY9□40-□-03	2 position	Single	3/8	7.9	0.34	2.0	9.6	0.43	2.6	469(172)	472(175)	493(196)	476(179)
		Double		7.5	0.33	1.8	7.3	0.30	1.7	488(191)	494(197)	535(239)	502(205)
	Closed center			7.2	0.34	1.7	13	0.23	2.8	512(215)	518(221)	560(263)	526(229)
	Exhaust center			[4.0]	[0.41]	[0.95]	[4.0]	[0.41]	[0.95]				
	Pressure center			12	0.26	2.8	6.7	0.40	1.9				
	SY9□40-□-04	2 position		Single	1/2	8.0	0.48	2.2	10	0.29	2.5	448 (172)	453 (175)
Double			7.6	0.32		1.8	7.3	0.32	1.8	467 (191)	473 (197)	515	481(205)
Closed center		7.3	0.42	2.0		13	0.32	3.6	491 (215)	497 (221)	539	505(229)	
Exhaust center		[4.7]	[0.54]	[1.5]		[4.7]	[0.54]	[1.5]					
Pressure center		12	0.33	3.3		7.4	0.33	1.9					[3.3]

Note 1) []: denotes the normal position. Note 2) (): denotes without sub-plate.

Construction

SY Series

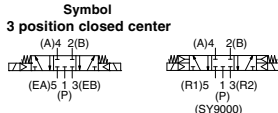
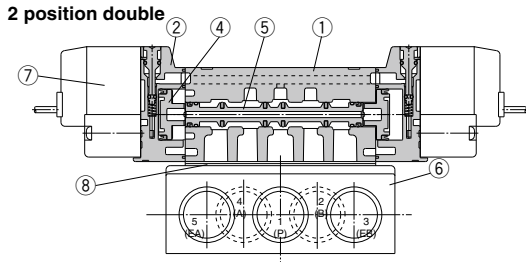
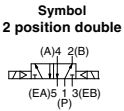
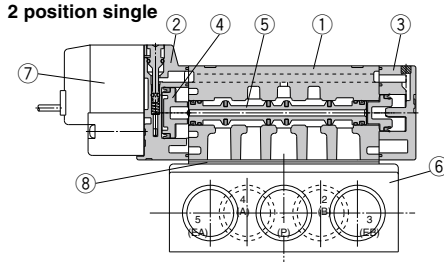
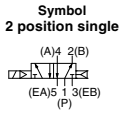

3 position closed center / exhaust center / pressure center

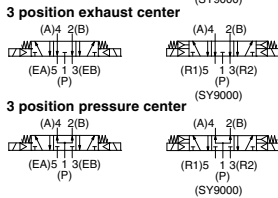
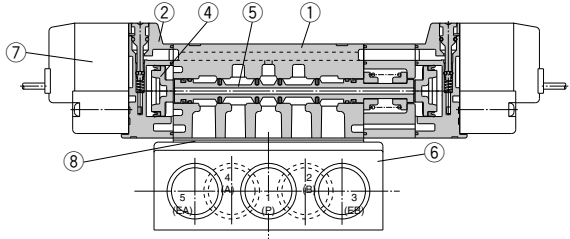

(This figure shows a closed center type.)

Component Parts

No.	Description	Material	Note
1	Body	Aluminum die-casted (SY3000: Zinc die-casted)	White
2	Adapter plate	Resin	White (SY9000: Gray)
3	End plate	Resin	White
4	Piston	Resin	-
5	Spool valve assembly	Aluminum, H-NBR	-

Replacement Parts

No.	Description	Part No.				Note
		SY3□40	SY5□40	SY7□40	SY9□40	
6	Sub-plate <small>(Note)</small>	SY3000-27-1□	SY5000-27-1□	1/4: SY7000-27-1□ 3/8: SY7000-27-2□	3/8: SY9000-27-1□ 1/2: SY9000-27-2□	Aluminum die-casted
7	Pilot valve assembly	Refer to "How to Order Pilot Valve Assembly" on page 629.				
8	Gasket	Standard: SY3000-11-25 CE-compliant: SY3000-11-25	SY5000-11-15 SY5000-11-18	SY7000-11-11 SY7000-11-14	SY9000-11-2 SY9000-11-2	H-NBR
-	Round head combination screw	SY3000-23-4	AC00077	AC00296	SY9000-18-2	For valve mounting
-	Reference screw size	(M2 x 21)	(M3 x 26)	(M4 x 31)	(M3 x 42)	(Matt nickel plated)

* Thread type

⚠ Caution

Mounting screw tightening torques

M2: 0.16 N·m
M3: 0.8 N·m
M4: 1.4 N·m

SY3000/5000/7000/9000 Series

How to Order Interface Regulator

SY3000 series

ARBY3000-05-P-2

Pressure gauge connection port

05	Pressure gauge (G15-10-01) (for odd number station)
06	Pressure gauge (G15-10-01) (for even number station)
M1	Plug (M-5P)

Regulating port

P	P port
A1	A port (P controlled type, A port regulation)
B1	B port (P controlled type, B port regulation)

ARBY3000-05-□-2

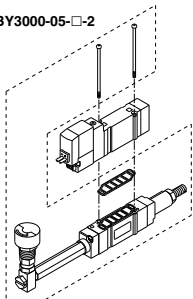

ARBY3000-M1-□-2

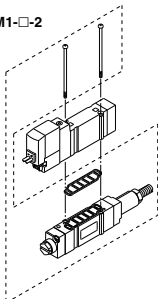

Note) The M8 connector for wiring cannot be mounted for the ARBY3000 series.

SY5000 series

ARBY5000-00-P-2

Pressure gauge connection port

00	Pressure gauge (G15-10-01)
M1	Plug (M-5P)

Regulating port

P	P port
A1	A port (P controlled type, A port regulation)
B1	B port (P controlled type, B port regulation)

ARBY5000-00-□-2

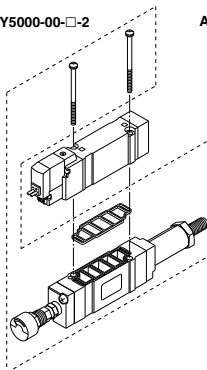

ARBY5000-M1-□-2

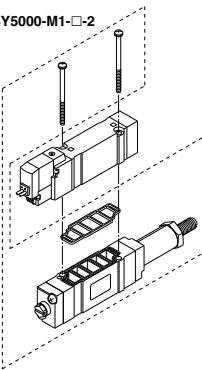

SY7000 series

ARBY7000-00-P-2

Pressure gauge connection port

00	Pressure gauge (G15-10-01)
M1	Plug (M-5P)

Regulating port

P	P port
A1	A port (P controlled type, A port regulation)
B1	B port (P controlled type, B port regulation)

ARBY7000-00-□-2

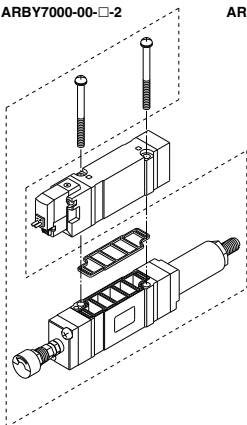

ARBY7000-M1-□-2

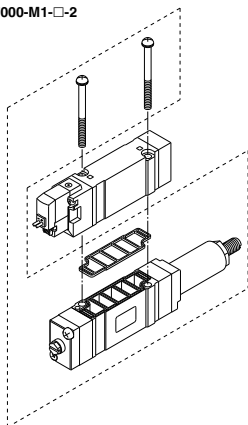

Note) ARBY is not CE-compliant.

Accessory

Series	Round head combination screw Reference screw size	Gasket
ARBY3000	SY3000-23-10 (M2 x 36)	SX3000-57-4
ARBY5000	AC00283 (M3 x 48.5)	SX5000-57-6
ARBY7000	AC00282 (M4 x 58)	SX7000-57-5

Caution

Mounting screw
tightening torques

M2: 0.16 N·m

M3: 0.8 N·m

M4: 1.4 N·m

Dimensions: SY3000 Series

[] : AC

2 position single

Grommet (G), (H): SY3140(R)-□^G□□-01□

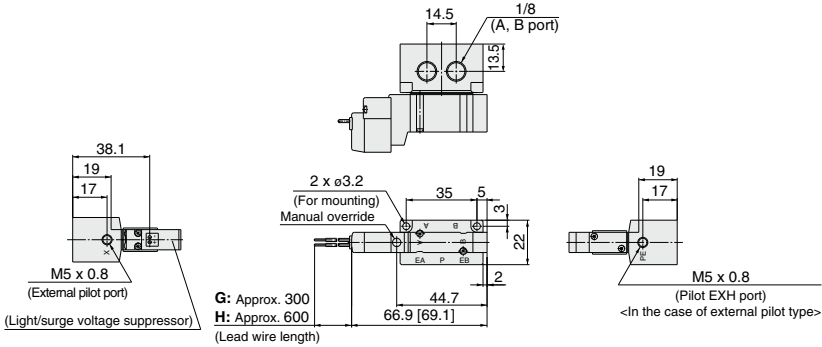

With interface regulator

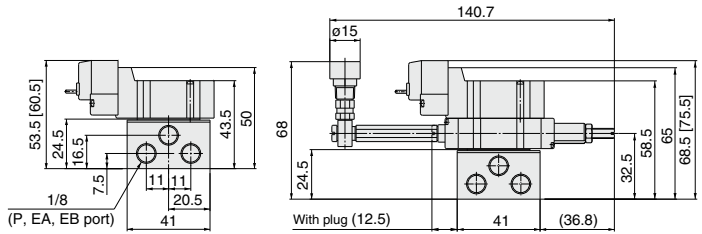

**L plug connector (L):
 SY3140(R)-□L□□-01□**

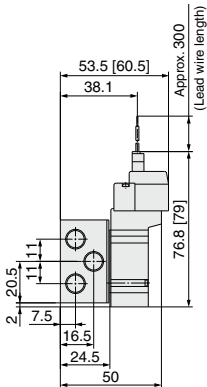

**M plug connector (M):
 SY3140(R)-□M□□-01□**

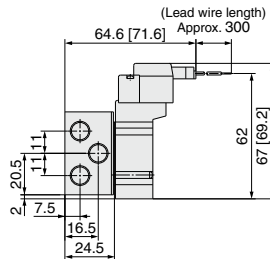

**M8 connector (WO):
 SY3140(R)-□WO□□-01□**

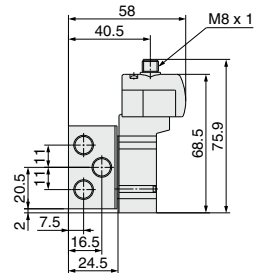

Note) Refer to page 642 for dimensions of connector types.

SY3000/5000/7000/9000 Series

Dimensions: SY3000 Series

[]: AC

2 position double

Grommet (G), (H): SY3240(R)-□^G□□-01□

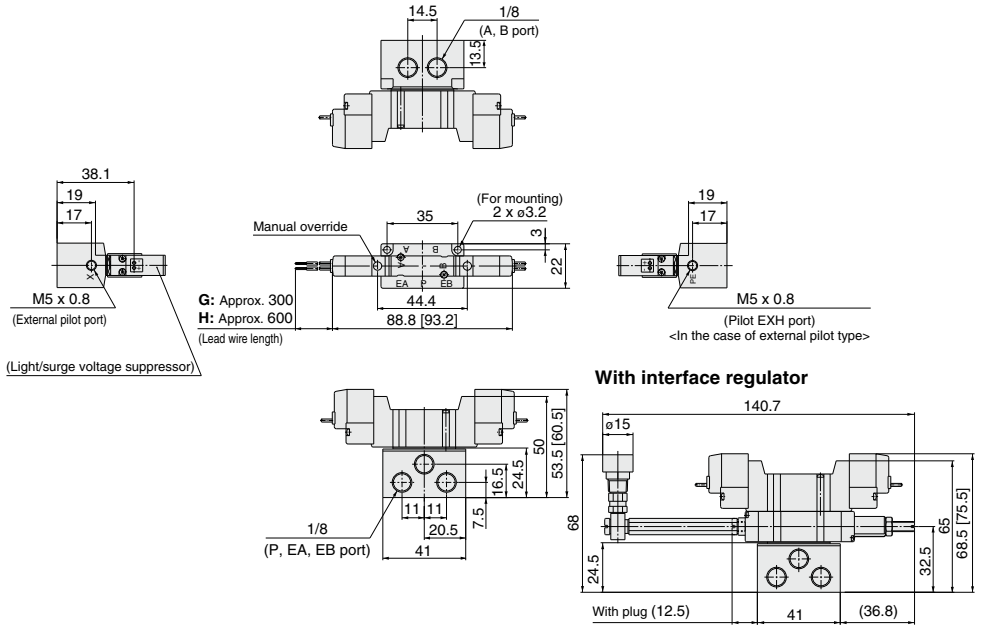

L plug connector (L):
 SY3240(R)-□L□□-01□

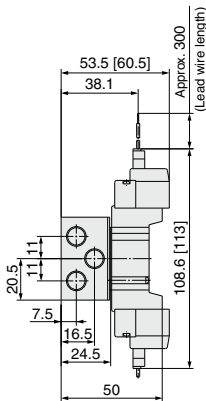

M plug connector (M):
 SY3240(R)-□M□□-01□

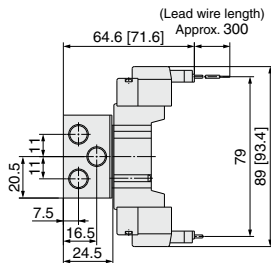

M8 connector (WO):
 SY3240(R)-□WO□□-01□

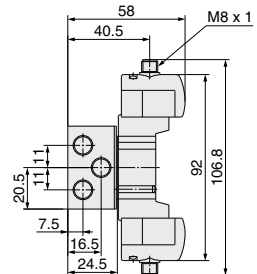

Note) Refer to page 642 for dimensions of connector types.

Dimensions: SY3000 Series

[] : AC

3 position closed center / exhaust center / pressure center

Grommet (G), (H): SY3 $\frac{3}{5}$ 40(R)-□G□□-01□

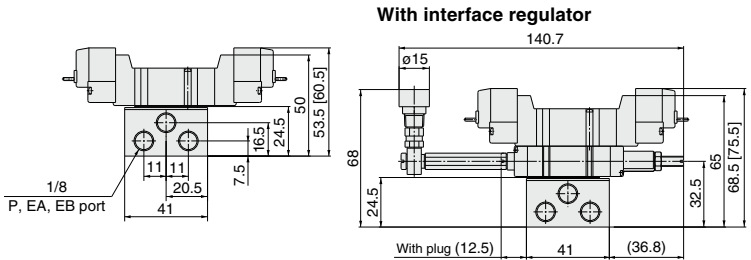
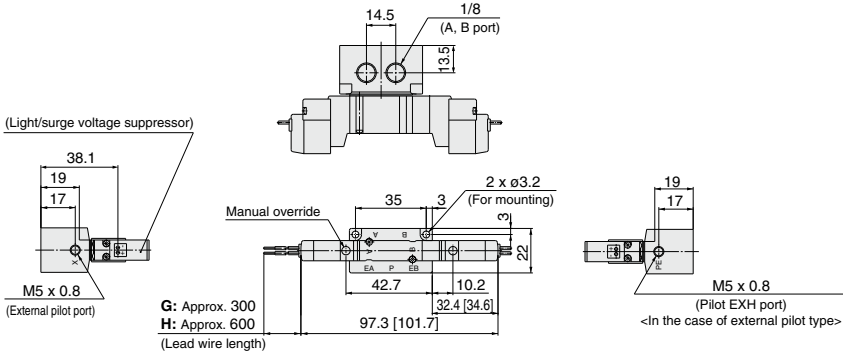

L plug connector (L):
SY3 $\frac{3}{5}$ 40(R)-□L□□-01□

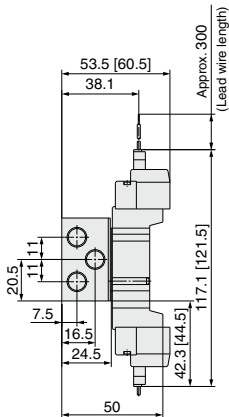

M plug connector (M):
SY3 $\frac{3}{5}$ 40(R)-□M□□-01□

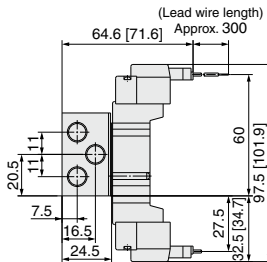

M8 connector (WO):
SY3 $\frac{3}{5}$ 40(R)-□WO□□-01□

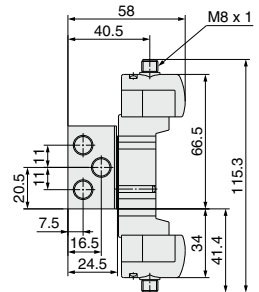

Note) Refer to page 642 for dimensions of connector types.

SY3000/5000/7000/9000 Series

Dimensions: SY5000 Series

[]: AC

2 position single

Grommet (G), (H): SY5140(R)-□^G□□□-02□

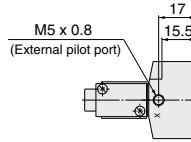
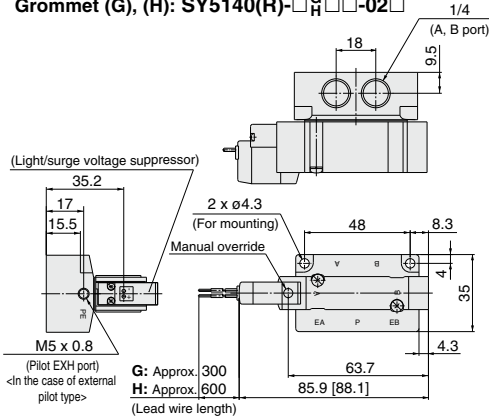

With interface regulator

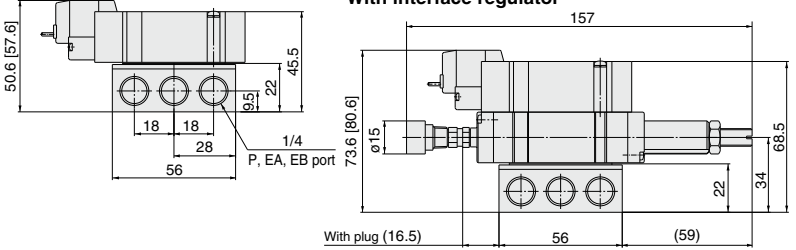

L plug connector (L): SY5140(R)-□L□□-02□

M plug connector (M): SY5140(R)-□M□□-02□

DIN terminal (D, Y): SY5140(R)-□D□□-02□

M8 connector (WO): SY5140(R)-□WO□□-02□

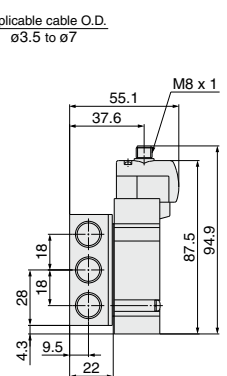
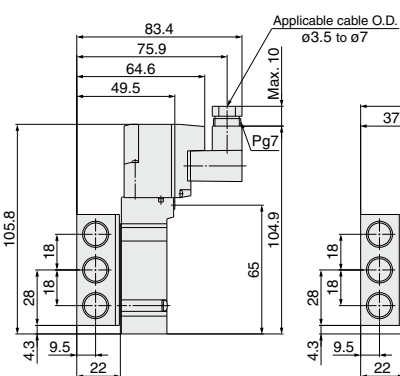
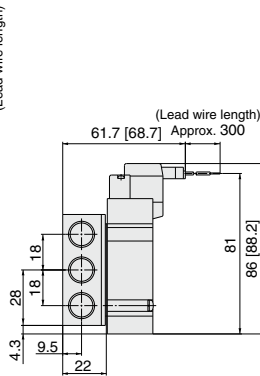
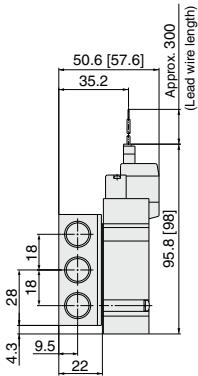

Note) Refer to page 642 for dimensions of connector types.

Dimensions: SY5000 Series

[]: AC

2 position double

Grommet (G), (H): SY5240(R)-□_G□□-02□

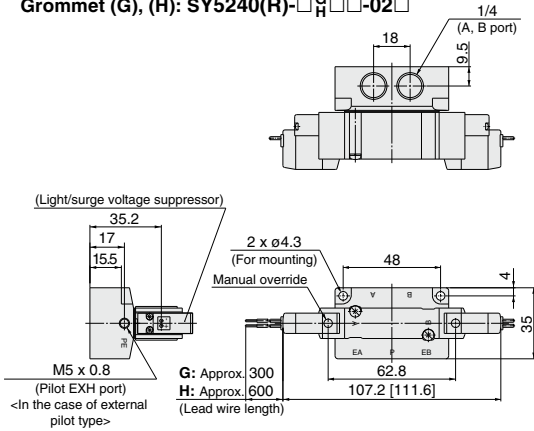

With interface regulator

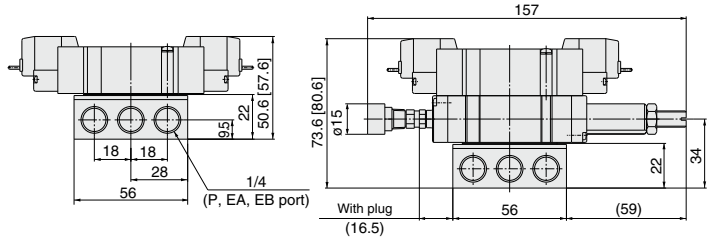

L plug connector (L): SY5240(R)-□L□□-02□

M plug connector (M): SY5240(R)-□M□□-02□

DIN terminal (D, Y): SY5240(R)-□Y□□-02□

M8 connector (WO): SY5240(R)-□WO□□-02□

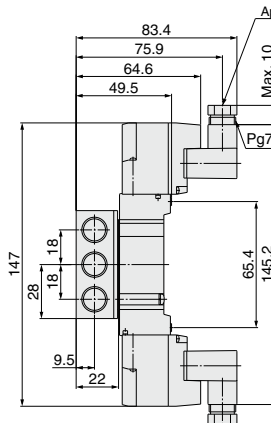
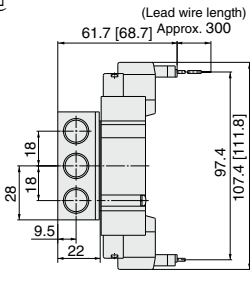
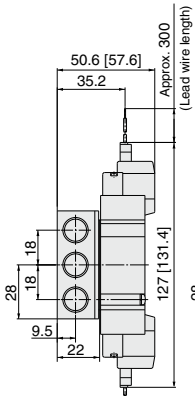

Applicable cable O.D.
 $\phi 3.5$ to $\phi 7$

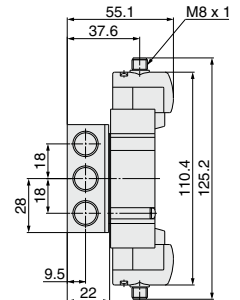

Note) Refer to page 642 for dimensions of connector types.

Dimensions: SY7000 Series

[] : AC

2 position single

Grommet (G), (H): SY7140(R)-□^G□□-02□□_H

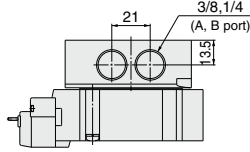

(Light/surge voltage suppressor)

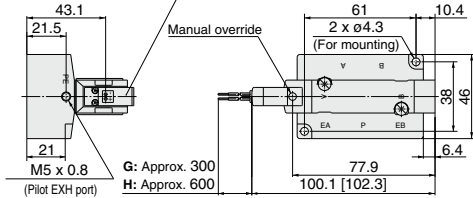

<In the case of external pilot type> (Lead wire length)

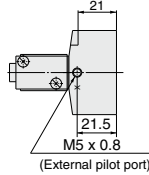

With interface regulator

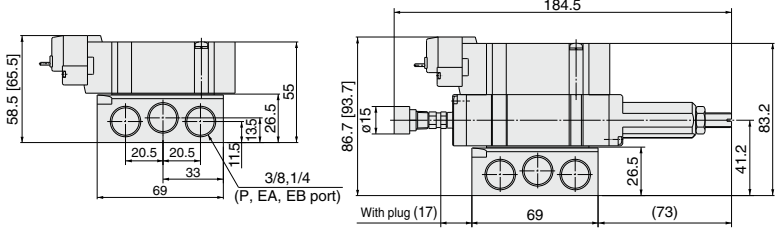

L plug connector (L): SY7140(R)-□L□□-02□□

M plug connector (M): SY7140(R)-□M□□-02□□

DIN terminal (D, Y): SY7140(R)-□D□□-02□□

M8 connector (WO): SY7140(R)-□WO□□-02□□

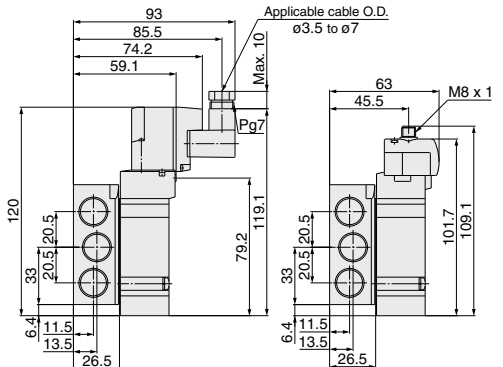
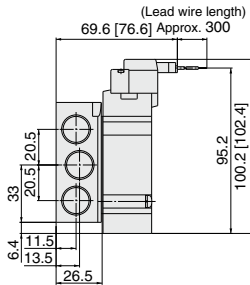
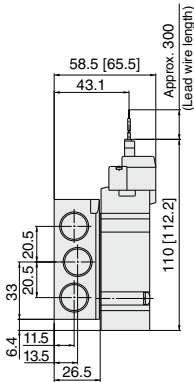

Note) Refer to page 642 for dimensions of connector types.

SJ
SY
SY
S0700
S0700

Dimensions: SY7000 Series

[]: AC

3 position closed center / exhaust center / pressure center

Grommet (G), (H): SY7³/₅40(R)-□G□□.02□□
 □H□□.03□□

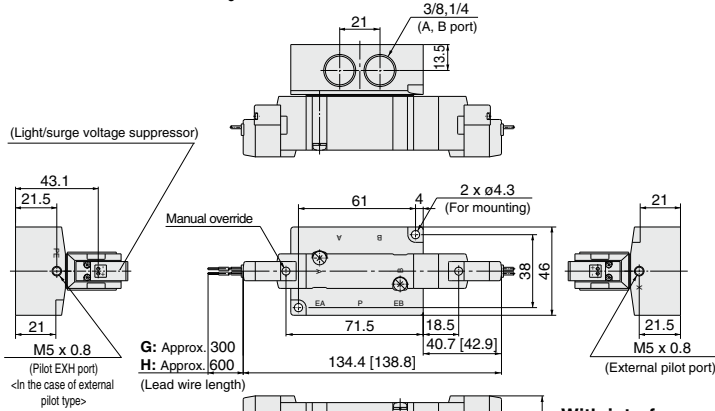

With interface regulator

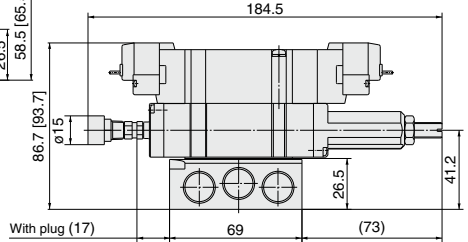

L plug connector (L):
 SY7³/₅40(R)-□L□□.02□□

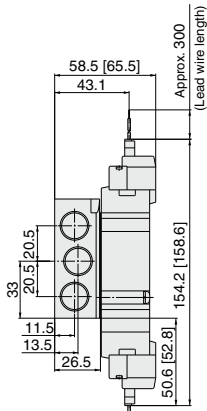

M plug connector (M):
 SY7³/₅40(R)-□M□□.02□□

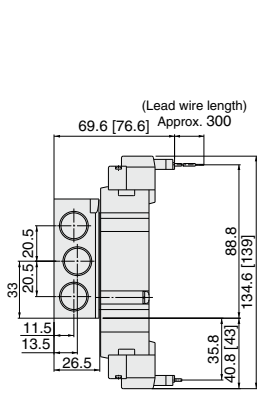

DIN terminal (D, Y):
 SY7³/₅40(R)-□Y□□.02□□

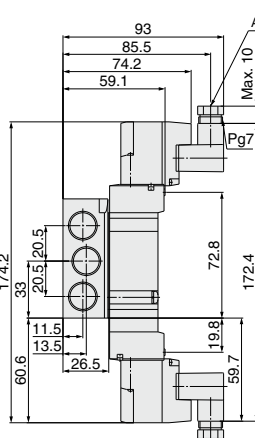

M8 connector (WO):
 SY7³/₅40(R)-□WO□□.02□□

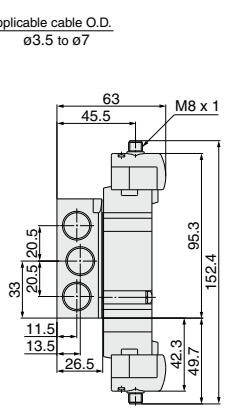

Note) Refer to page 642 for dimensions of connector types.

SJ
SY
SY
S0700
S0700

SY3000/5000/7000/9000 Series

Dimensions: SY9000 Series

[]: AC

2 position single

Grommet (G), (H): SY9140(R)-□_G□□-03□₀₄

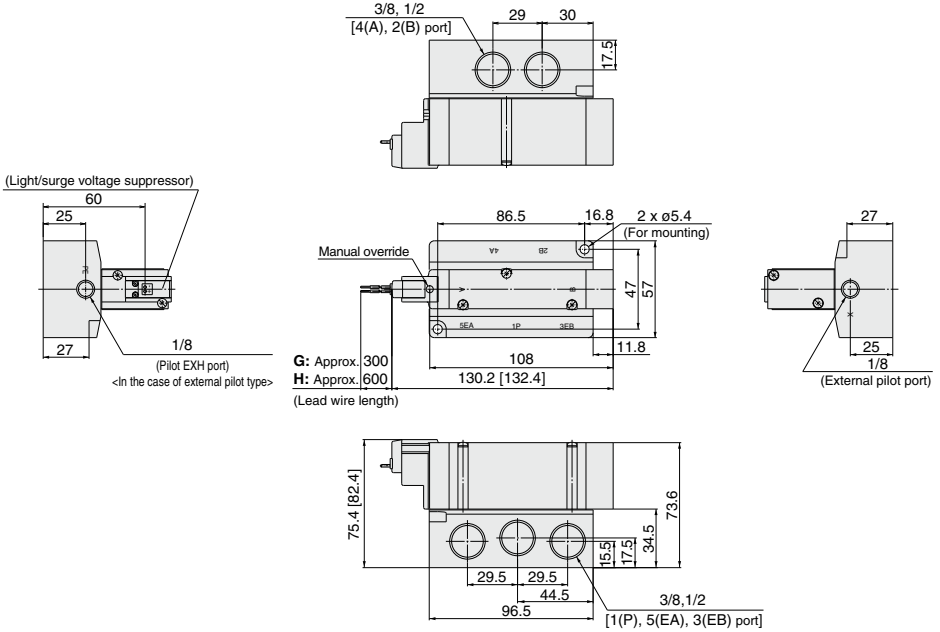

L plug connector (L):
 SY9140(R)-□L□□-03□₀₄

M plug connector (M):
 SY9140(R)-□M□□-03□₀₄

DIN terminal (D, Y):
 SY9140(R)-□D□□-03□₀₄

M8 connector (WO):
 SY9140(R)-□WO□□-03□₀₄

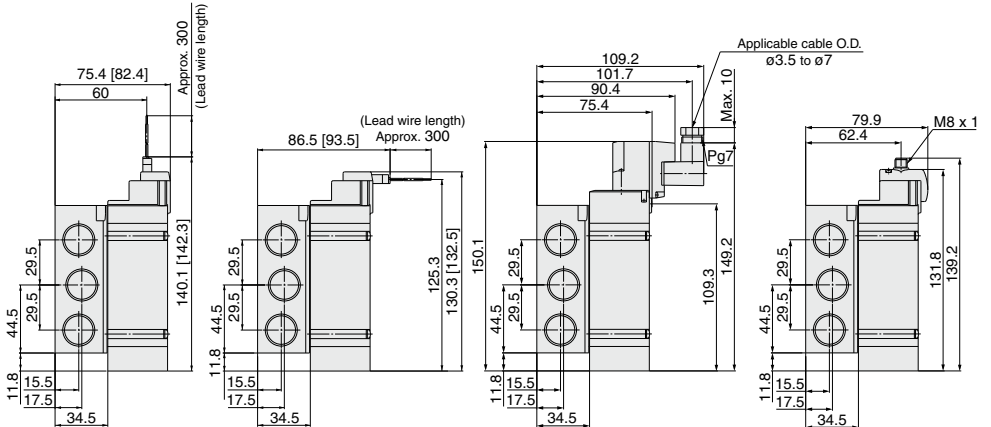

Note) Refer to page 642 for dimensions of connector types.

Dimensions: SY9000 Series

[] : AC

2 position double

Grommet (G), (H): SY9240(R)-□G□□□-03□□

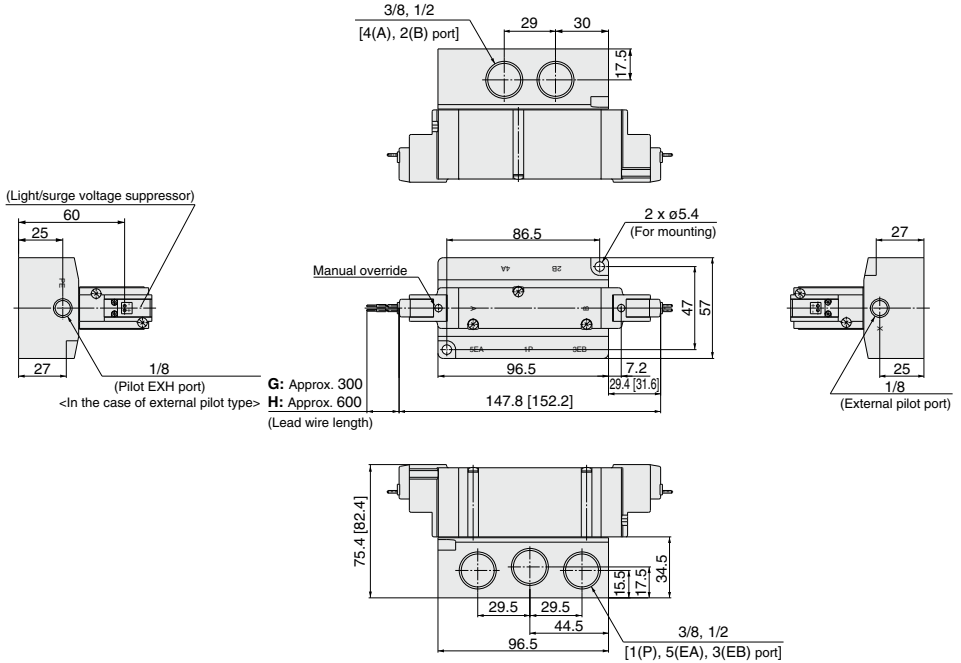

SJ
SY
SY
S0700
S0700

L plug connector (L): SY9240(R)-□L□□□-03□□

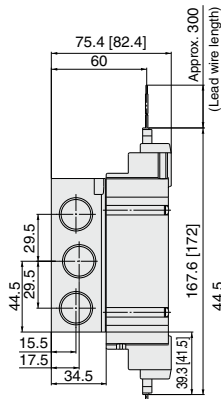

M plug connector (M): SY9240(R)-□M□□□-03□□

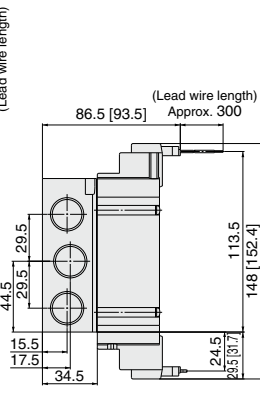

DIN terminal (D, Y): SY9240(R)-□D□□□-03□□

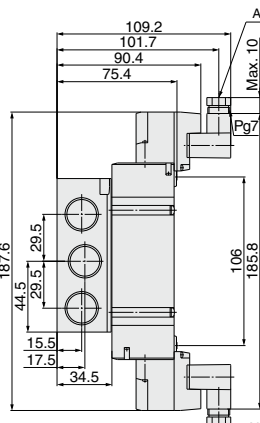

M8 connector (WO): SY9240(R)-□WO□□□-03□□

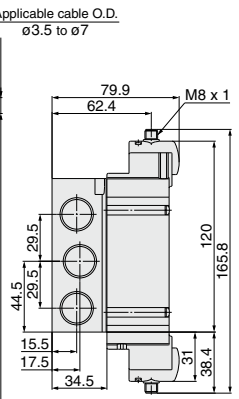

Note) Refer to page 642 for dimensions of connector types.

SY3000/5000/7000/9000 Series

Dimensions: SY9000 Series

[]: AC

3 position closed center / exhaust center / pressure center

Grommet (G), (H): SY9³/₅40(R)-□□□□-⁰³/₀₄□

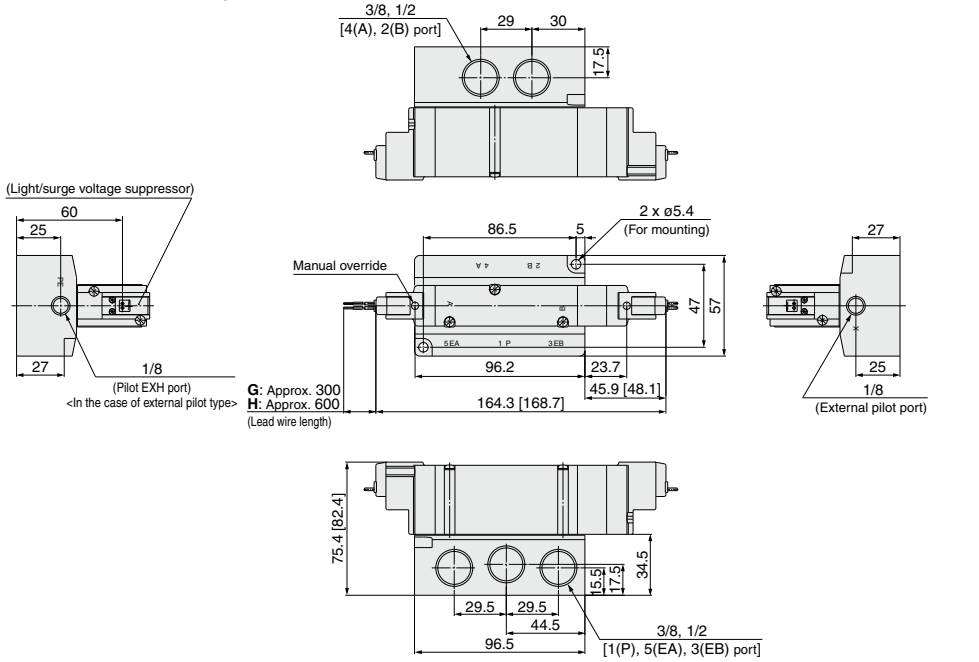

L plug connector (L):
 SY9³/₅40(R)-□□□□-⁰³/₀₄□

M plug connector (M):
 SY9³/₅40(R)-□M□□-⁰³/₀₄□

DIN terminal (D, Y):
 SY9³/₅40(R)-□□□□-⁰³/₀₄□

M8 connector (WO):
 SY9³/₅40(R)-□WO□□-⁰³/₀₄□

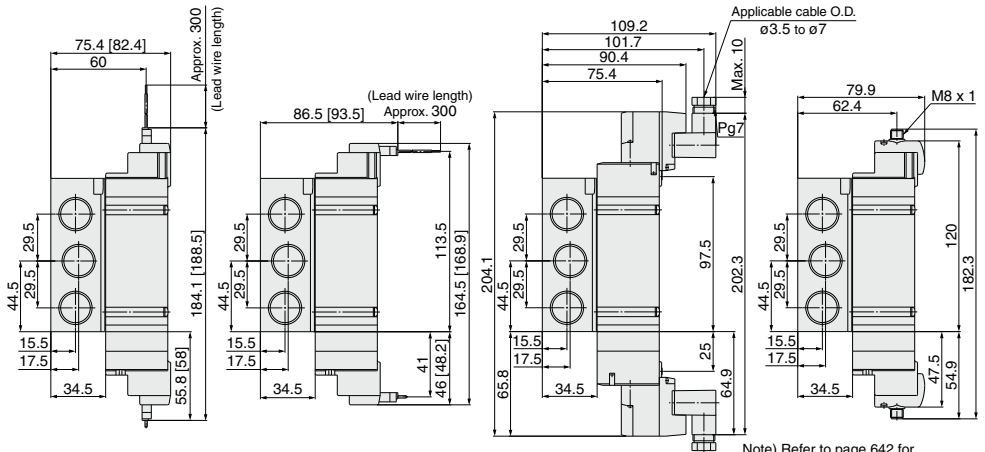

Note) Refer to page 642 for dimensions of connector types.

SJ
SY
SY
S0700
S0700

5 Port Solenoid Valve Body Ported Manifold Bar Stock Type/Individual Wiring



 [Option]

SY3000/5000/7000 Series

Type **20**

How to Order Manifold

SS5Y **5** - **20** - **05** - -

Manifold series

3	SY3000
5	SY5000
7	SY7000

Stations

02	2 stations
⋮	⋮
20	20 stations

* This also includes the number of blanking plate assemblies.

Thread type

NII	Rc
00F	G
00N	NPT
00T	NPTF

CE-compliant

NII	—
Q	CE-compliant

Note) AC-type models that are CE-compliant have DIN terminals only.

How to Order Manifold Assembly (Example)

Example

Cylinder port size

C6: With One-touch fitting for ø6

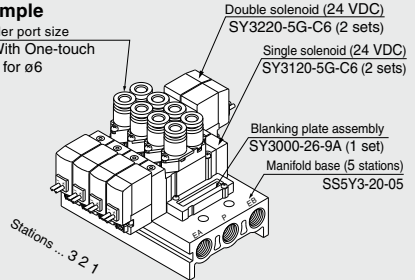

SS5Y3-20-05 1 set (Type 20, 5-station manifold base part no.)

* SY3000-26-9A 1 set (Blanking plate assembly part no.)

* SY3120-5G-C6 ... 2 sets (Single solenoid part no.)

* SY3220-5G-C6 ... 2 sets (Double solenoid part no.)

↳ The asterisk denotes the symbol for assembly.

Prefix it to the part nos. of the solenoid valve, etc.

Add the valve and option part number under the manifold base part number. In the case of complex arrangement, specify them on the manifold specification sheet.



Note) AC-type models that are CE-compliant have DIN terminals only.

How to Order Valve

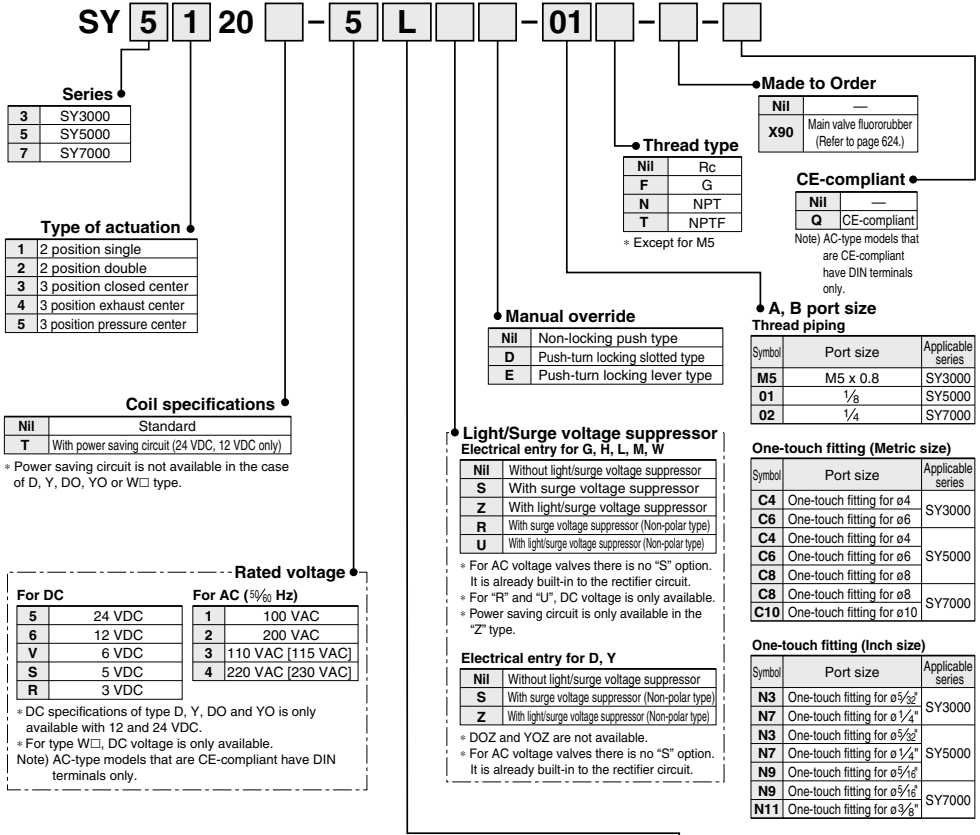

SY
SY
S0700
S0700

Rated voltage

For DC		For AC (50/60 Hz)	
5	24 VDC	1	100 VAC
6	12 VDC	2	200 VAC
V	6 VDC	3	110 VAC [115 VAC]
S	5 VDC	4	220 VAC [230 VAC]
R	3 VDC		

* DC specifications of type D, Y, DO and YO is only available with 12 and 24 VDC.
* For type W□, DC voltage is only available.
Note) AC-type models that are CE-compliant have DIN terminals only.

Electrical entry

	24, 12, 6, 5, 3 VDC/ 100, 110, 200, 220 VAC	24, 12 VDC/ 100, 110, 200, 220 VAC		24, 12, 6, 5, 3 VDC		
		Grommet	L plug connector		M plug connector	DIN terminal
Manifold mounting	SY3000	●	●	●	●	●
	SY5000 SY7000	●	●	●	●	●
CE-compliant	DC	●	●	●	●	●
	AC	—	—	—	●	—

Note 1) The DIN terminal of the SY3000 series cannot be mounted on a standard manifold. For details, refer to page 639.
Note 2) Enter the cable length symbols in □. Please be sure to fill in the blank referring to page 642.
* LN, MN type: with 2 sockets.
* "Y" type is a DIN terminal conforming to EN-175301-803C (former DIN43850C).
For details, refer to page 638.
* For connector cable of M8 connector, refer to page 641.
* M8 thread conforming to IEC60947-5-2 standard is also available. Refer to page 623 for details.
* Refer to page 638 for the lead wire length of L and M plug connectors.
* Refer to page 639 for the connector assembly with cover for L and M plug connectors.

Note) When placing an order for body ported solenoid valve as a single unit, mounting screw for manifold and gasket are not attached. Order them separately, if necessary.

Gasket assembly part no.

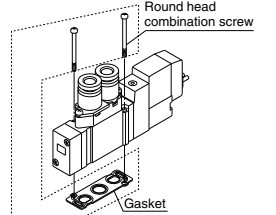

Series	Gasket assembly part no.
SY3000	SY3000-GS-1
SY5000	SY5000-GS-1
SY7000	SY7000-GS-1

Note) The gasket assembly includes 10 sets of mounting screws and a gasket.



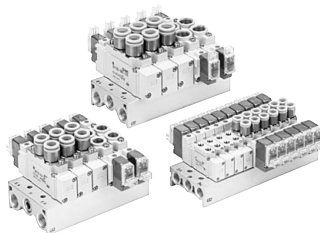

Manifold Specifications

Model	SS5Y3-20(-Q)	SS5Y5-20(-Q)	SS5Y7-20(-Q)	
Applicable valve	SY3□20	SY5□20	SY7□20	
Manifold type	Single base/B mount			
P (SUP)/R (EXH)	Common SUP, Common EXH			
Valve stations	2 to 20 stations ^{Note1)}			
A, B port location	Valve			
Port size	P, EA, EB port	1/8	1/4	1/4
	A, B port	M5 x 0.8 C4 (One-touch fitting for ø4) C6 (One-touch fitting for ø6)	1/8 C4 (One-touch fitting for ø4) C6 (One-touch fitting for ø6) C8 (One-touch fitting for ø8)	1/4 C8 (One-touch fitting for ø8) C10 (One-touch fitting for ø10)
Manifold base weight W (g)	W = 13n + 24	W = 36n + 64	W = 43n + 35	
n: Stations				

Note 1) For more than 10 stations (more than 5 stations in case of SS5Y7), supply pressure to P port on both sides and exhaust from EA/EB port on both sides.

Note 2) Refer to "Manifold Option" on page 467.

Flow Rate Characteristics

Model	Port size		Flow rate characteristics					
	1, 5, 3 (P, EA, EB)	4, 2 (A, B)	1 → 4/2 (P → A/B)			4/2 → 5/3 (A/B → EA/EB)		
			C (dm ³ /(s·bar))	b	Cv	C (dm ³ /(s·bar))	b	Cv
SS5Y3-20(-Q)	1/8	C6	0.72	0.29	0.18	0.80	0.36	0.21
SS5Y5-20(-Q)	1/4	C8	1.9	0.28	0.48	2.2	0.20	0.53
SS5Y7-20(-Q)	1/4	C10	3.6	0.31	0.93	3.6	0.27	0.88

Note) The value is for manifold base with 5 stations and individually operated 2 position type.

SY3000: SS5Y3-20-Stations - []

[] : AC

Grommet (G)

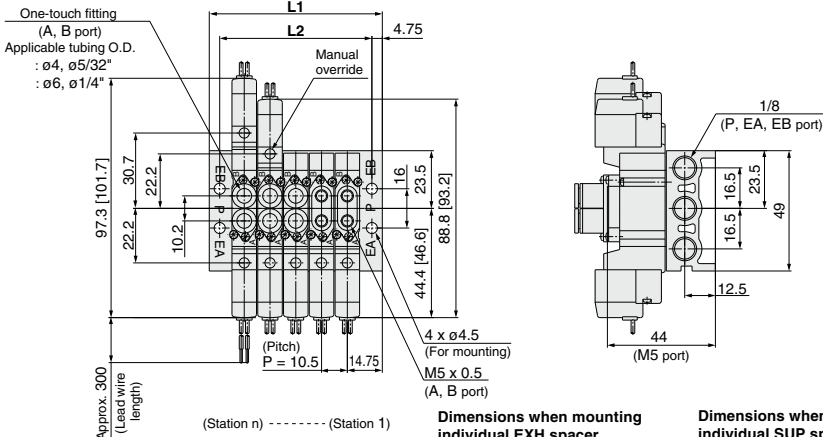

SJ
SY
SY
S0700
S0700

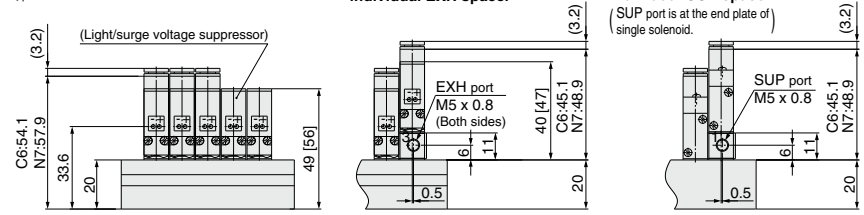

L plug connector (L)

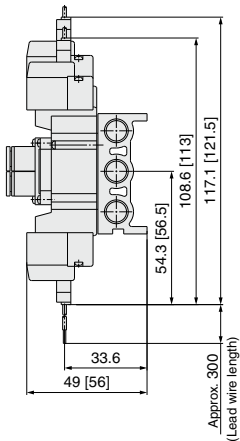

M plug connector (M)

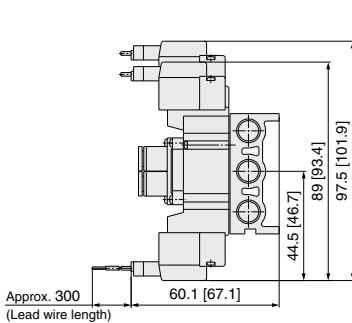

M8 connector (WO)

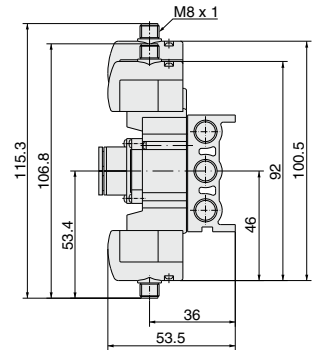

Note) Refer to page 642 for dimensions of connector types.

Stations n	2 stations	3	4	5	6	7	8	9	10	11	12	13	14	15	16	17	18	19	20 stations
L1	40	50.5	61	71.5	82	92.5	103	113.5	124	134.5	145	155.5	166	176.5	187	197.5	208	218.5	229
L2	30.5	41	51.5	62	72.5	83	93.5	104	114.5	125	135.5	146	156.5	167	177.5	188	198.5	209	219.5

SY7000: SS5Y7-20-Stations -

[]: AC

Grommet (G)

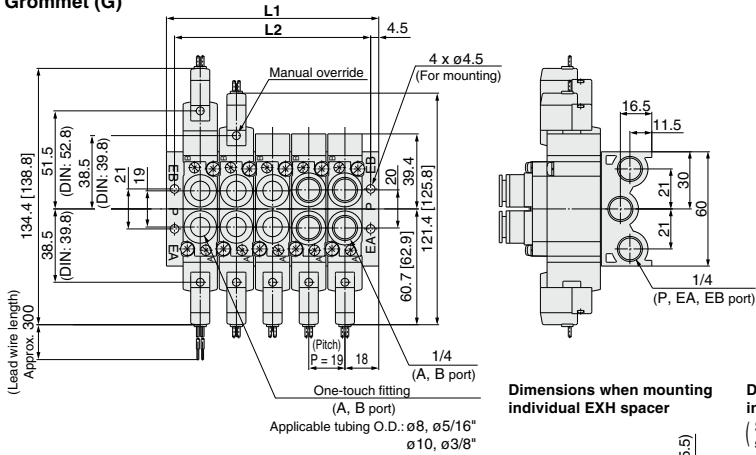

Dimensions when mounting individual EXH spacer

Dimensions when mounting individual SUP spacer
(SUP port is at the end plate of single solenoid.)

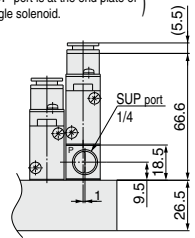
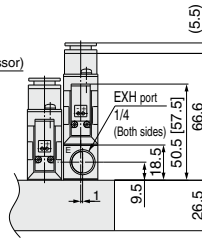
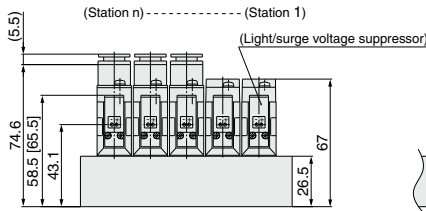

L plug connector (L)

M plug connector (M)

DIN terminal (D, Y)

M8 connector (WO)

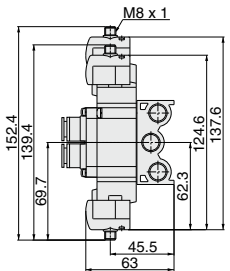
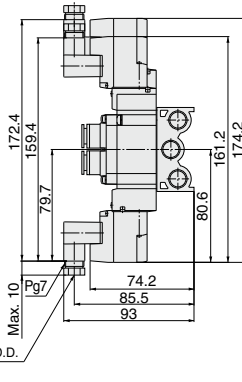
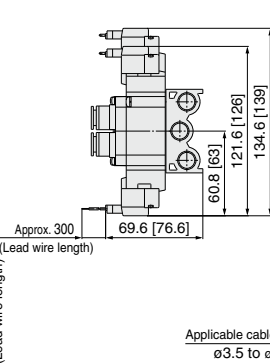
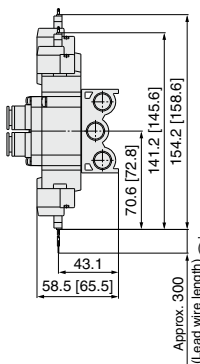

Note) Refer to page 642 for dimensions of connector types.

Stations n	2 stations	3	4	5	6	7	8	9	10	11	12	13	14	15	16	17	18	19	20 stations
L1	55	74	93	112	131	150	169	188	207	226	245	264	283	302	321	340	359	378	397
L2	46	65	84	103	122	141	160	179	198	217	236	255	274	293	312	331	350	369	388

5 Port Solenoid Valve Body Ported Manifold Stacking Type/Individual Wiring **SY9000 Series**

Type **23**

CE
[Option]

How to Order Manifold

Type 23/External pilot capable

SS5Y9-23-05 - [] - [] - []

Manifold series

9	SY9000
---	--------

Valve stations

Symbol	Stations
02	2 stations
:	:
20	20 stations

* This also includes the number of blanking plate assemblies.

Thread type

Nil	Rc
00F	G
00N	NPT
00T	NPTF

Option

Symbol	Mounting
Nil	Direct mounting
D	DIN rail mounting (with DIN rail)
DO	DIN rail mounting (without DIN rail)
D*	When a longer DIN rail is desired than the specified stations, specify the station number to be required into * mark.

CE-compliant

Nil	—
Q	CE-compliant

Note) AC-type models that are CE-compliant have DIN terminals only.

How to Order Manifold Assembly (Example)

Example

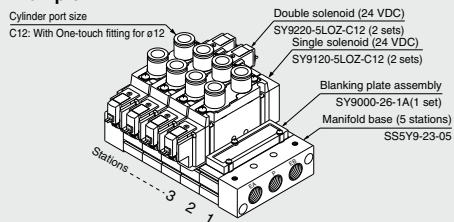

- SS5Y9-23-05 1 set (Type 23, 5-station manifold base part no.)
 * SY9000-26-1A 1 set (Blanking plate assembly part no.)
 * SY9120-5LOZ-C12 ... 2 sets (Single solenoid part no.)
 * SY9220-5LOZ-C12 ... 2 sets (Double solenoid part no.)

The asterisk denotes the symbol for assembly. Prefix it to the part nos. of the solenoid valve, etc.

Add the valve and option part number under the manifold base part number. In the case of complex arrangement, specify them on the manifold specification sheet.



Note) AC-type models that are CE-compliant have DIN terminals only.

How to Order Valve

SY 9 1 20 - **5 L** - **02**

Series

9	SY9000
---	--------

Type of actuation

1	2 position single
2	2 position double
3	3 position closed center
4	3 position exhaust center
5	3 position pressure center

Pilot specifications

Nil	Internal pilot
R	External pilot

* In the case of external pilot specifications, it cannot be used as a single unit.

Coil specifications

Nil	Standard
T	With power saving circuit (24 VDC, 12 VDC only)

* Power saving circuit is not available in the case of D, Y, DO, YO or W□ type.

Rated voltage

For DC		For AC (%/50 Hz)	
5	24 VDC	1	100 VAC
6	12 VDC	2	200 VAC
V	6 VDC	3	110 VAC [115 VAC]
S	5 VDC	4	220 VAC [230 VAC]
R	3 VDC		

* DC specifications of type D, Y, DO and YO is only available with 12 and 24 VDC.
* For type W□, DC voltage is only available.
Note) AC-type models that are CE-compliant have DIN terminals only.

Made to Order

Nil	—
X90	Main valve fluororubber (Refer to page 624.)

Thread type

Nil	Rc
F	G
N	NPT
T	NPTF

Manual override

Nil	Non-locking push type
D	Push-turn locking slotted type
E	Push-turn locking lever type

Light/Surge voltage suppressor
Electrical entry for G, H, L, M, W

Nil	Without light/surge voltage suppressor
S	With surge voltage suppressor
Z	With light/surge voltage suppressor
R	With surge voltage suppressor (Non-polar type)
U	With light/surge voltage suppressor (Non-polar type)

* For AC voltage valves there is no "S" option. It is already built-in to the rectifier circuit.
* For "R" and "U", DC voltage is only available.
* Power saving circuit is only available in the "Z" type.

Electrical entry for D, Y

Nil	Without light/surge voltage suppressor
S	With surge voltage suppressor
Z	With light/surge voltage suppressor

* DOZ and YOZ are not available.
* For AC voltage valves there is no "S" option. It is already built-in to the rectifier circuit.

A, B port size Thread piping

Symbol	Port size
02	1/4
03	3/8

One-touch fitting (Metric size)

Symbol	Port size
C8	One-touch fitting for ø8
C10	One-touch fitting for ø10
C12	One-touch fitting for ø12

One-touch fitting (Inch size)

Symbol	Port size
N9	One-touch fitting for ø5/16"
N11	One-touch fitting for ø3/8"

SJ

SY

SY

S0700

S0700

Electrical entry

	24, 12, 6, 5, 3 VDC/ 100, 110, 200, 220 VAC			24, 12 VDC/ 100, 110, 200, 220 VAC	24, 12, 6, 5, 3 VDC
	Grommet	L plug connector	M plug connector	DIN terminal	M8 connector
G: Lead wire length 300 mm	L: With lead wire (Length 300 mm)	M: With lead wire (Length 300 mm)	D: With connector	DC: Without connector	WC: Without connector cable
H: Lead wire length 600 mm	LN: Without lead wire	MN: Without lead wire	Y: With connector	YC: Without connector	WC: With connector cable (Note)
	LO: Without connector	MO: Without connector	YO: Without connector		
CE-compliant	DC ●	●	●	●	●
AC	—	—	—	●	—

* LN, MN type: with 2 sockets.

* "Y" type is a DIN terminal conforming to EN-175301-803C (former DIN43650C). For details, refer to page 638.

* For connector cable of M8 connector, refer to page 641.

* M8 connector conforming to IEC60947-5-2 standard is also available. Refer to page 623 for details.

* Refer to page 638 for the lead wire length of L and M plug connectors.

* Refer to page 639 for the connector assembly with cover for L and M plug connectors.

Note) Enter the cable length symbols in □. Please be sure to fill in the blank referring to page 642.

Note) When placing an order for body ported solenoid valve as a single unit, mounting screw for manifold and gasket are not attached. Order them separately, if necessary.

Gasket assembly part no.

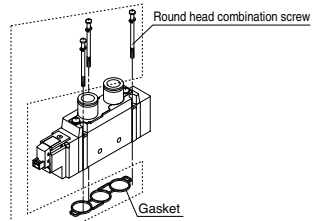

Series	Gasket assembly part no.
SY9000	SY9000-GS-1

Note) The gasket assembly includes 10 sets of mounting screws and a gasket.

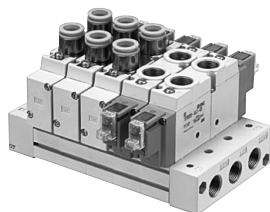

Manifold Specifications

Model	SS5Y9-23(-Q)	
Applicable valve	SY9□20	
Manifold type	Stacking type	
P (SUP)/R (EXH)	Common SUP, Common EXH	
Valve stations	2 to 20 stations ^{Note 1)}	
A, B port location	Valve	
Port size	P, EA, EB port	3/8
	A, B port	1/4
		3/8
		C8 (One-touch fitting for ø8) C10 (One-touch fitting for ø10) C12 (One-touch fitting for ø12)
Manifold base weight W (g) n: Stations	W = 66n + 246	

Note 1) For more than 10 stations, supply pressure to P port on both sides and exhaust from EA/EB port on both sides.

Note 2) Refer to "Manifold Option" on page 467.

Flow Rate Characteristics

Model	Port size		Flow rate characteristics					
	1, 5, 3 (P, EA, EB)	4, 2 (A, B)	1 → 4/2 (P → A/B)			4/2 → 5/3 (A/B → EA/EB)		
			C (dm ³ /s·bar)	b	Cv	C (dm ³ /s·bar)	b	Cv
SS5Y9-23(-Q)	3/8	C12	6.3	0.20	1.5	8.2	0.28	1.9

Note) The value is for manifold base with 5 stations and individually operated 2 position type.

SY9000: SS5Y9-23- Stations -(D)

[] : AC

Grommet (G)

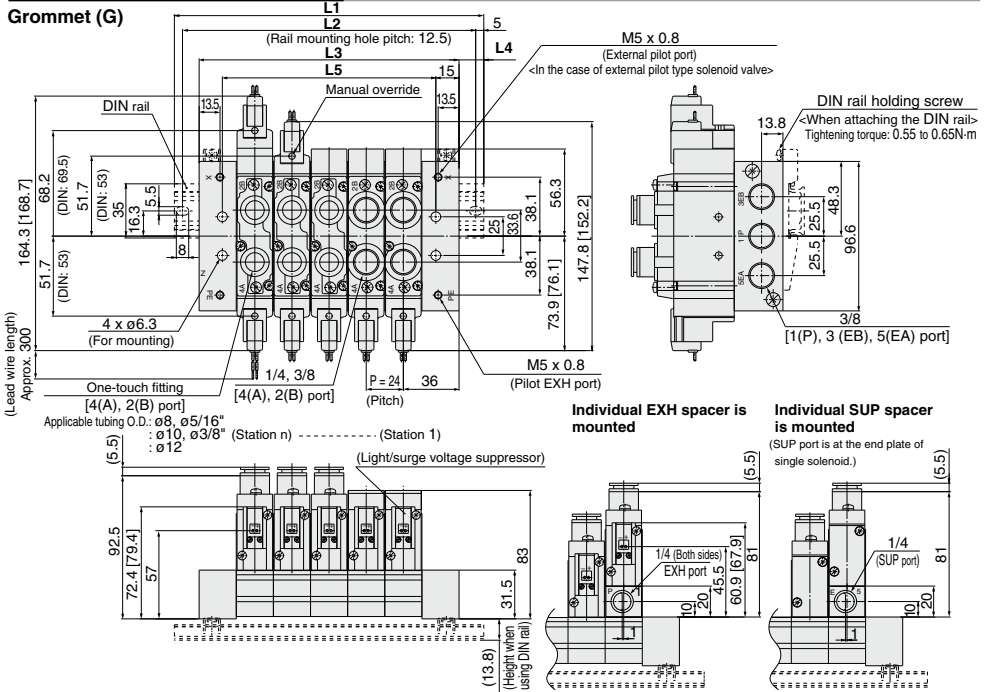

- SJ**
- SY**
- SY**
- S0700**
- S0700**

L plug connector (L)

M plug connector (M)

DIN terminal (D, Y)

M8 connector (WO)

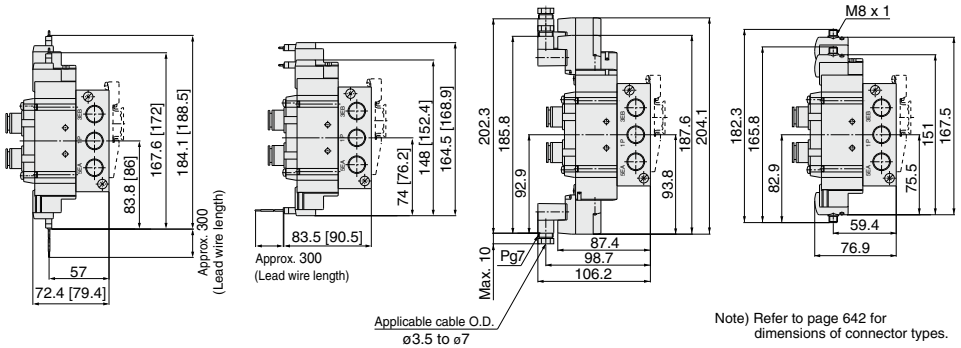

Stations n	2 stations	3	4	5	6	7	8	9	10	11	12	13	14	15	16	17	18	19	20 stations
L1	123	148	173	198	223	248	273	298	323	335.5	360.5	385.5	410.5	435.5	460.5	485.5	510.5	535.5	560.5
L2	112.5	137.5	162.5	187.5	212.5	237.5	262.5	287.5	312.5	325	350	375	400	425	450	475	500	525	550
L3	96	120	144	168	192	216	240	264	288	312	336	360	384	408	432	456	480	504	528
L4	13.5	14	14.5	15	15.5	16	16.5	17	17.5	12	12.5	13	13.5	14	14.5	15	15.5	16	16.5
L5	66	90	114	138	162	186	210	234	258	282	306	330	354	378	402	426	450	474	498

Note) In the case of direct mounting without DIN rail, total width of manifold is L3.

Type **20P**

5 Port Solenoid Valve Body Ported Manifold Bar Stock Type/Flat Ribbon Cable **SY3000/5000/7000 Series**

How to Order Manifold

Note) CE-compliant:
For DC only.



SS5Y **5** - 20P - **05** - [] - []

Manifold series

3	SY3000
5	SY5000
7	SY7000

Stations

03	3 stations
:	:
12	12 stations

Note) SS5Y3 has 4
to 12 stations.

Thread type

Nil	Rc
00F	G
00N	NPT
00T	NPTF

CE-compliant

Nil	—
Q	CE-compliant

Note) CE-compliant: For
DC only.

How to Order Manifold Assembly (Example)

Example

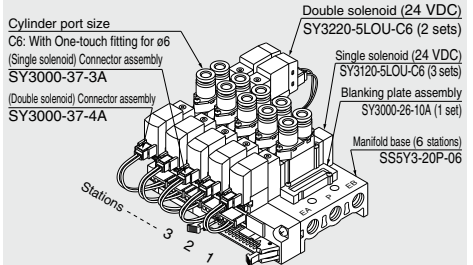

- SS5Y3-20P-06 1 set (Type 20P, 6-station manifold part no.)
 * SX3000-26-10A 1 set (Blanking plate assembly part no.)
 * SY3120-5LOU-C6... 3 sets (Single solenoid part no.)
 * SY3220-5LOU-C6... 2 sets (Double solenoid part no.)
 * SY3000-37-3A 3 sets (Connector assembly part no.)
 * SY3000-37-4A 2 sets (Connector assembly part no.)

The asterisk denotes the symbol for assembly.
Prefix it to the part nos. of the solenoid valve, etc.

Add the valve and option part number under the manifold base part number.
In the case of complex arrangement, specify them on the manifold specification sheet.

Note) Please indicate the connector assembly part no. below that connects the valve and the manifold.

Connector Assembly

For 12, 24 VDC

Specifications	For SY3000	For SY5000/7000
For single solenoid	SY3000-37-3A	SY5000-37-3A
Double solenoid, 3 position type	SY3000-37-4A	SY5000-37-4A
Single with spacer assembly	SY5000-37-3A	SY5000-37-5A
Double, 3 position with spacer assembly	SY3000-37-6A	SY5000-37-6A

Note) Spacer assembly indicates Individual SUP/EXH.

For 100 VAC

Specifications	For SY3000	For SY5000/7000
For single solenoid	SY3000-37-32A	SY5000-37-15A
Double solenoid, 3 position type	SY3000-37-33A	SY5000-37-16A
Single with spacer assembly	SY5000-37-15A	SY5000-37-17A
Double, 3 position with spacer assembly	SY3000-37-34A	SY5000-37-18A

For 100 VAC (115 VAC)

Specifications	For SY3000	For SY5000/7000
For single solenoid	SY3000-37-35A	SY5000-37-19A
Double solenoid, 3 position type	SY3000-37-36A	SY5000-37-20A
Single with spacer assembly	SY5000-37-19A	SY5000-37-21A
Double, 3 position with spacer assembly	SY3000-37-37A	SY5000-37-22A

⚠ Caution

- For non-polar (U) valves, the electrical DC connections can be used with either positive and negative COM. For type (Z), only use with positive COM as the valve does not operate correctly when used with negative COM.



How to Order Valve

Note) CE-compliant:
For DC only. [Option]

•Coil specifications

Nil	Standard
T	With power saving circuit

•Rated voltage CE-compliant

5	24 VDC	●
6	12 VDC	●

•Light/surge voltage suppressor

Z	With light/surge voltage suppressor
U	With light/surge voltage suppressor (Non-polar type)

Note) Z: Positive common specifications only.
* Power saving circuit is only available in the "Z" type.

Note) In the case of flat cable type, "U" and "Z" types are for DC specifications and "Z" type is for AC specifications. "Z" for DC is positive common specifications only. For the other combination, please contact SMC.

•CE-compliant

Nil	—
Q	CE-compliant

Note) CE-compliant: For DC only.

•Thread type

Nil	Rc
F	G
N	NPT
T	NPTF

* Except for M5

•A, B port size
Thread piping

Symbol	Port size	Applicable series
M5	M5 x 0.8	SY3000
O1	1/8	SY5000
O2	1/4	SY7000

One-touch fitting (Inch size)

Symbol	Port size	Applicable series
N3	One-touch fitting for $\phi 3/8"$	SY3000
N7	One-touch fitting for $\phi 1/4"$	SY3000
N3	One-touch fitting for $\phi 3/8"$	SY3000
N7	One-touch fitting for $\phi 1/4"$	SY5000
N9	One-touch fitting for $\phi 3/8"$	SY5000
N9	One-touch fitting for $\phi 3/8"$	SY7000
N11	One-touch fitting for $\phi 3/8"$	SY7000

Note) When placing an order for body ported solenoid valve as a single unit, mounting screw for manifold and gasket are not attached. Order them separately, if necessary.
Note) Since the electrical entry is "LO", select a connector assembly part no. from those stated on page 448.

•Type of actuation

1	2 position single
2	2 position double
3	3 position closed center
4	3 position exhaust center
5	3 position pressure center

•Rated voltage CE-compliant

1	100 VAC	—
3	110 VAC (115 VAC)	—

Note) CE-compliant: For DC only.

•Manual override

Nil	Non-locking push type
D	Push-turn locking slotted type
E	Push-turn locking lever type

Series

3	SY3000
5	SY5000
7	SY7000

For DC: SY 5 1 20 [] - 5 LO Z [] - 01 [] - []
For AC: SY 5 1 20 - 1 LO Z [] - 01 [] - []

SJ
SY
SY
S0700
S0700

■Gasket assembly part no.

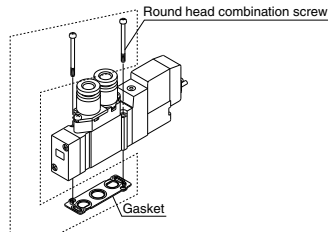

Series	Gasket assembly part no.
SY3000	SY3000-GS-1
SY5000	SY5000-GS-1
SY7000	SY7000-GS-1

Note) The gasket assembly includes 10 sets of mounting screws and a gasket.

- Multiple valve wiring is simplified through the use of the flat cable connector
- Clean appearance

In the case of a flat ribbon cable type, each valve is wired on the print board of manifold base to allow the external wiring to be piped all together with 26 pins MIL connector.

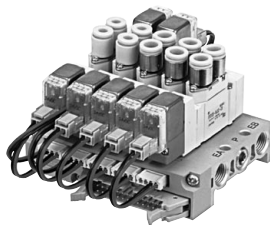

Manifold Specifications

Model	SS5Y3-20P(-Q)	SS5Y5-20P(-Q)	SS5Y7-20P(-Q)
Applicable valve	SY3□20	SY5□20	SY7□20
Manifold type	Single base/B mount		
P (SUP/R (EXH))	Common SUP, Common EXH		
Valve stations	4 to 12 stations ⁽¹⁾	3 to 12 stations ^(Note 1)	
A, B port location	Valve		
P, EA, EB port	1/8	1/4	1/4
Port size	M5 x 0.8,	1/8	1/4
	C4 (One-touch fitting for ø4)	C4 (One-touch fitting for ø4)	C8 (One-touch fitting for ø8)
	C6 (One-touch fitting for ø6)	C6 (One-touch fitting for ø6)	C10 (One-touch fitting for ø10)
Manifold base weight W (g)	W = 19n + 45	W = 43n + 77	W = 51n + 81
n: Stations			
Applicable flat ribbon cable connector	Flat ribbon cable connector, Socket: 26 pins MIL type with strain relief, Conforming to MIL-C-83503		
Internal wiring	In common between +COM and -COM (Z type: +COM only).		
Rated voltage ^(Note 4)	12, 24 VDC 100, 110 VAC		

Note 1) For more than 10 stations (more than 5 stations in case of SS5Y7), supply pressure to P port on both sides and exhaust from EA/EB port on both sides.

Note 2) The withstand voltage specification for the wiring unit section is JIS C 0704, Grade 1 or its equivalent.

Note 3) Refer to "Manifold Option" on page 467.

Note 4) CE-compliant: For DC only.

Flow Rate Characteristics

Model	Port size		Flow rate characteristics					
	1, 5, 3 (P, EA, EB)	4, 2 (A, B)	1 → 4/2 (P → A/B)			4/2 → 5/3 (A/B → EA/EB)		
			C [dm ³ /(s·bar)]	b	Cv	C [dm ³ /(s·bar)]	b	Cv
SS5Y3-20P	1/8	C6	0.72	0.29	0.18	0.80	0.36	0.21
SS5Y5-20P	1/4	C8	1.9	0.28	0.48	2.2	0.20	0.53
SS5Y7-20P	1/4	C10	3.6	0.31	0.93	3.6	0.27	0.88

Note) The value is for manifold base with 5 stations and individually operated 2 position type.

Internal Wiring of Manifold

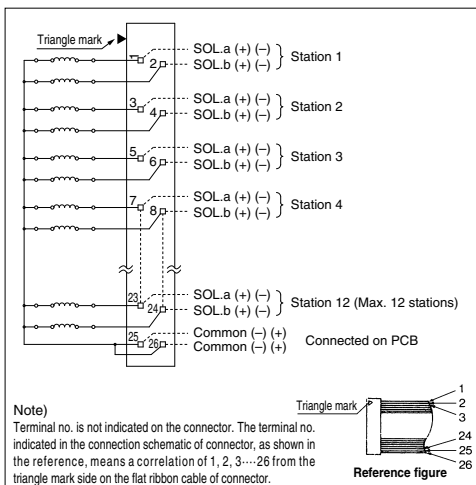

Caution

- For non-polar (U) valves, the electrical DC connections can be used with either positive and negative COM. For type (Z), only use with positive COM as the valve does not operate correctly when used with negative COM.

- For more than 10 stations, both poles of the common should be wired.
- For single solenoid, connect to the solenoid A side.
- The maximum number of stations that can be accommodated is 12. For more stations, please contact SMC.

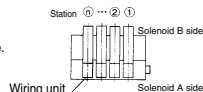

SY3000: SS5Y3-20P- Stations

[]: AC

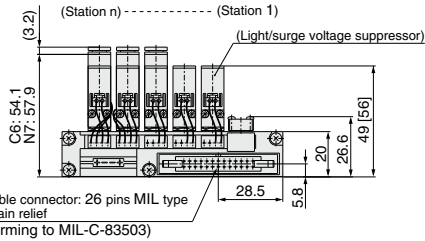
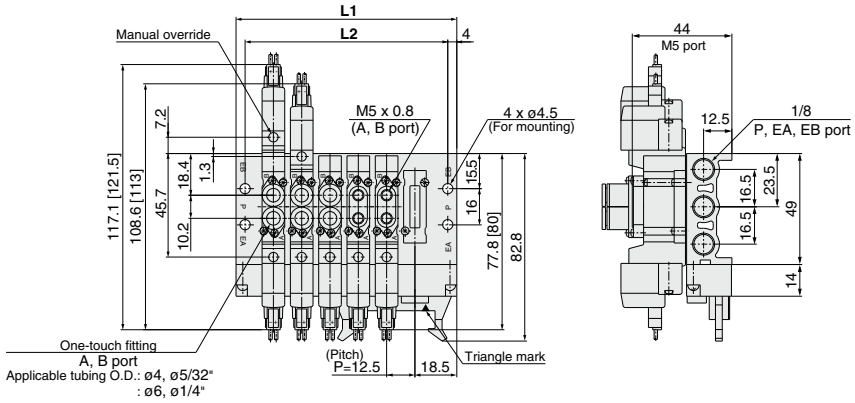

Stations n	4	5	6	7	8	9	10	11	12
L1	72.5	85	97.5	110	122.5	135	147.5	160	172.5
L2	64.5	77	89.5	102	114.5	127	139.5	152	164.5

- SJ**
- SY**
- SY**
- S0700**
- S0700**

SY5000: SS5Y5-20P-Stations

[]: AC

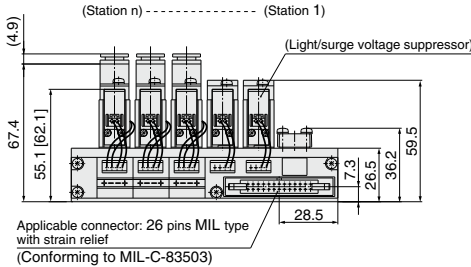
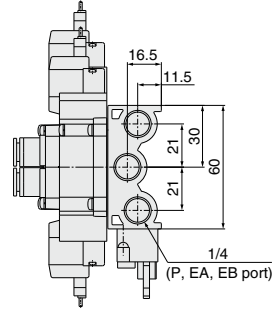
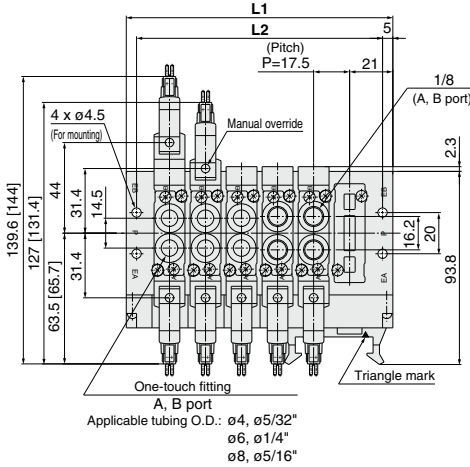

Stations n	3	4	5	6	7	8	9	10	11	12
L1	77	94.5	112	129.5	147	164.5	182	199.5	217	234.5
L2	67	84.5	102	119.5	137	154.5	172	189.5	207	224.5

SY7000: SS5Y7-20P- Stations

[] : AC

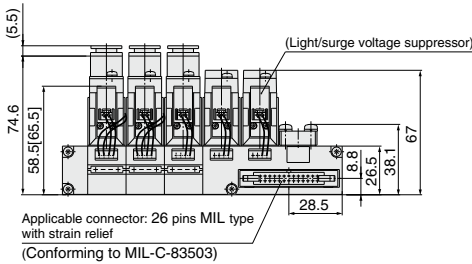
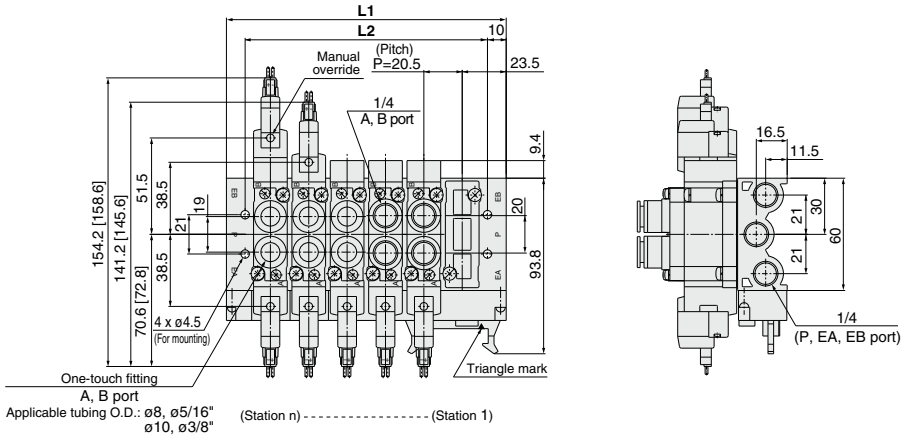

Stations n	3	4	5	6	7	8	9	10	11	12
L1	88	108.5	129	149.5	170	190.5	211	231.5	252	272.5
L2	68	88.5	109	129.5	150	170.5	191	211.5	232	252.5

5 Port Solenoid Valve Body Ported Manifold Stacking Type/Flat Ribbon Cable

Type **23P**

SY9000 Series

Note) CE-compliant:
For DC only. [Option]



How to Order Manifold

Type 23P/Common external pilot capable

SS5Y 9 - 23P - 05 - [] - [] - []

Manifold series
9 SY9000

Valve stations

Symbol	Stations
04	4 stations
:	:
12	12 stations

* This also includes the number of blanking plate assemblies.

Thread type

NII	Rc
00F	G
00N	NPT
00T	NPTF

Option

Symbol	Mounting
NII	Direct mounting
D	DIN rail mounting (with DIN rail)
DO	DIN rail mounting (without DIN rail)
D*	When a longer DIN rail is desired than the specified stations, specify the station number to be required into * mark.

CE-compliant

NII	—
Q	CE-compliant

Note) CE-compliant: For DC only.

How to Order Manifold Assembly (Example)

Example

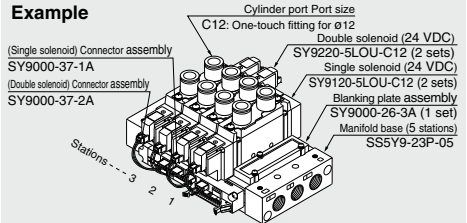

SS5Y9-23P-05 1 set (Type 23, 5-station manifold base part no.)
 *SY9000-26-3A 1 set (Blanking plate assembly part no.)
 *SY9120-SLOU-C12 ... 2 sets (Single solenoid part no.)
 *SY9220-SLOU-C12 ... 2 sets (Double solenoid part no.)
 *SY9000-37-1A 2 sets (Connector assembly part no.)
 *SY9000-37-2A 2 sets (Connector assembly part no.)

The asterisk denotes the symbol for assembly. Prefix it to the part nos. of the solenoid valve, etc.

Add the valve and option part number under the manifold base part number. In the case of complex arrangement, specify them on the manifold specification sheet.

Note) Please indicate the connector assembly part no. (page 455) that connects the valve and the manifold.

How to Order Valve

Coil specifications

NII	Standard
T	With power saving circuit

Rated voltage

5	24 VDC	CE-compliant
6	12 VDC	CE-compliant

Light/Surge voltage suppressor

Z	With light/surge voltage suppressor	Note) Z: Positive common specifications only.
U	With light/surge voltage suppressor (Non-polar type)	* Power saving circuit is only available in the "Z" type.

CE-compliant

NII	—
Q	CE-compliant

Note) CE-compliant: For DC only.

Thread type

NII	Rc
F	G
N	NPT
T	NPTF

For DC: SY 9 1 20 [] [] - 5 LO Z [] - 02 [] - []

For AC: SY 9 1 20 [] [] - 1 LO Z [] - 02 [] - []

Series

9 SY9000

Type of actuation

1	2 position single
2	2 position double
3	3 position closed center
4	3 position exhaust center
5	3 position pressure center

Pilot specifications

NII	Internal pilot
R	External pilot

* Type 23P manifolds can be used for both internal and external pilots.

Rated voltage

1	100 VAC	CE-compliant
3	110 VAC (115 VAC)	CE-compliant

Note) CE-compliant: For DC only.

Manual override

NII	Non-locking push type
D	Push-turn locking slotted type
E	Push-turn locking lever type

A, B port size

Thread piping

Symbol	Port size
02	1/4
03	3/8

One-touch fitting (Metric size)

Symbol	Port size
C8	One-touch fitting for ø8
C10	One-touch fitting for ø10
C12	One-touch fitting for ø12

One-touch fitting (Inch size)

Symbol	Port size
N9	One-touch fitting for ø5/16"
N11	One-touch fitting for ø3/8"

Gasket assembly part no.

Round head combination screw

Series	Gasket assembly part no.
SY9000	SY9000-GS-1

Note) The gasket assembly includes 10 sets of mounting screws and a gasket.



- Multiple valve wiring is simplified through the use of the flat cable connector.
- Clean appearance

In the case of a flat ribbon cable type, each valve is wired on the print board of manifold base to allow the external wiring to be piped all together with 26 pins MIL connector.

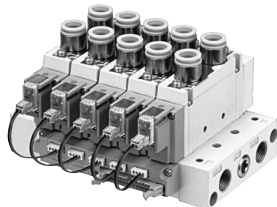

Manifold Specifications

Model	SS5Y9-23P(-Q)	
Applicable valve	SY9□20	
Manifold type	Stacking type	
P (SUP)/R (EXH)	Common SUP, Common EXH	
Valve stations	4 to 12 stations ^{Note1)}	
A, B port location	Valve	
Port size	P, EA, EB port	3/8
	A, B port	1/4
		3/8
		C8 (One-touch fitting for ø8) C10 (One-touch fitting for ø10) C12 (One-touch fitting for ø12)
Manifold base weight W (g)	W = 73n + 259	
n: Stations		
Applicable flat ribbon cable connector	Flat ribbon cable connector, Socket: 26 pins MIL with strain relief, Conforming to MIL-C-83503	
Internal wiring	In common between +COM and -COM (Z type: +COM only)	
Rated voltage ^{Note4)}	12, 24 VDC, 100, 110 VAC	

Note 1) For more than 10 stations, supply pressure to P port on both sides and exhaust from EA/EB port on both sides.
 Note 2) The withstand voltage specification for the wiring unit section is JIS C 0704, Grade 1 or its equivalent.
 Note 3) Refer to "Manifold Option" on page 467.
 Note 4) CE-compliant: For DC only.

Connector Assembly

For 12, 24 VDC

Specifications	For SY9000
For single solenoid	SY9000-37-1A
Double solenoid 3 position	SY9000-37-2A
Single with spacer assembly	SY9000-37-3A
Double, 3 position with spacer assembly	SY9000-37-4A

For 100 VAC

Specifications	For SY9000
For single solenoid	SY9000-37-1B
Double solenoid 3 position	SY9000-37-2B
Single with spacer assembly	SY9000-37-3B
Double, 3 position with spacer assembly	SY9000-37-4B

For 110 VAC (115 VAC)

Specifications	For SY9000
For single solenoid	SY9000-37-1C
Double solenoid 3 position	SY9000-37-2C
Single with spacer assembly	SY9000-37-3C
Double, 3 position with spacer assembly	SY9000-37-4C

Note) Spacer assembly indicates individual SUP/EXH.

Flow Rate Characteristics

Model	Port size		Flow rate characteristics					
	1, 5, 3 (P, EA, EB)	4, 2 (A, B)	1 → 4/2 (P → A/B)			4/2 → 5/3 (A/B → EA/EB)		
			C (dm ³ /s/bar)	b	Cv	C (dm ³ /s/bar)	b	Cv
SS5Y9-23P(-Q)	3/8	C12	6.3	0.20	1.5	8.2	0.28	1.9

Note) The value is for manifold base with 5 stations and individually operated 2 position type.

Internal Wiring of Manifold

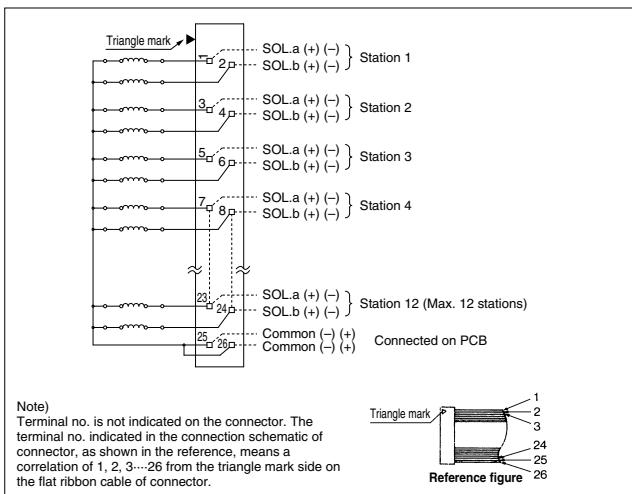

- For more than 10 stations, both poles of the common should be wired.
- For single solenoid, connect to the solenoid A side.
- The maximum number of stations that can be accommodated is 12. For more stations, please contact SMC.

Caution

- For non-polar (U) valves, the electrical DC connections can be used with either positive and negative COM. For type (Z), only use with positive COM as the valve does not operate correctly when used with negative COM.

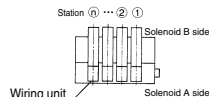

SJ
SY
SY
S0700
S0700

Type **20SA**

EX510 Gateway-type Serial Transmission System Body Ported Manifold/Integrated Base **SY3000/5000/7000 Series**



How to Order Manifold

SS5Y 3 - 20SA - 04 - - -

Manifold series

3	SY3000
5	SY5000
7	SY7000

SI unit

NII	NPN output (+COM.)
N	PNP output (-COM.)

SI unit part no.

Symbol	SI unit specifications	SI unit part no.	Page
NII	NPN output (+COM.)	EX510-S001	P.897
N	PNP output (-COM.)	EX510-S101	

Refer to page 878 and the Operation Manual for the details of EX510 Gateway-type Serial Transmission System. Please download the Operation Manual via our website, <http://www.smcworld.com>

CE-compliant

NII	—
Q	CE-compliant

P, R port thread type

NII	Rc
00F	G
00N	NPT
00T	NPTF

Valve stations

Symbol	Stations	Note
03	3 stations	Double wiring ^{Note 1)}
:	:	
08	8 stations	Specified layout ^{Note 2)} (Compatible with 16 solenoid valves)
03	3 stations	
:	:	
16	16 stations	

• SSSY3 can be set from 4 stations.

• The number of the blanking plate assembly is also included.

Note 1) Double wiring: Use of a single solenoid will result in an unused control signal. If this is not desired, order with a specified layout.

Note 2) Specified layout: Indicate wiring specifications on the manifold specification sheet. (Note that double and 3 position valves cannot be used where single solenoid wiring has been specified.)

How to Order Manifold Assembly (Example)

Example

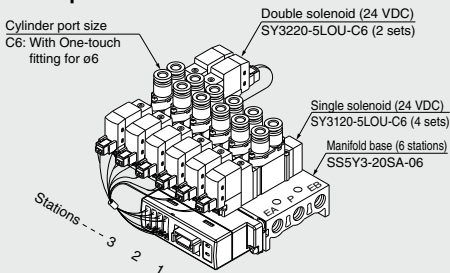

SSSY3-20SA-06 1 set (20SA type 6-station manifold part no.)
 * SY3120-5LOU-C6 4 sets (Single solenoid part no.)
 * SY3220-5LOU-C6 2 sets (Double solenoid part no.)

—The asterisk denotes the symbol for assembly. Prefix to the part no. of the solenoid valve, etc.

Add the valve and option part number under the manifold base part number.

When entry of part numbers becomes complicated, indicate by the manifold specification sheet. For a manifold for an EX510, the length of the lead wire for a connector assembly depends on the number of stations. Therefore, the manifold assembly is shipped with the valves (including blanking plates) and connector assembly mounted on it, as the standard specification. Be sure to specify the part nos. of the solenoid valves to be mounted.

How to Order Valves

SY 3 1 20 [] - 5 LO Z [] - M5 [] - []

Series

3	SY3000
5	SY5000
7	SY7000

Type of actuation

1	2 position single
2	2 position double
3	3 position closed center
4	3 position exhaust center
5	3 position pressure center

Coil specifications

Nil	Standard
T	With power saving circuit

Rated voltage: 24 VDC

Light/Surge voltage suppressor

Z	With light/surge voltage suppressor
U	With light/surge voltage suppressor (non-polar type)

Note 1) Power saving circuit is only available in the "Z" type.

Note 2) When the SI unit is the PNP output (-COM.), only the "U" type is available.

Manual override

Nil	Non-locking push type
D	Push-turn locking slotted type
E	Push-turn locking lever type

CE-compliant

Nil	—
Q	CE-compliant

Thread type

Nil	Rc
F	G
N	NPT
T	NPTF

A, B port size

Thread piping

M5	M5 x 0.8	SY3000
01	1/8	SY5000
02	1/4	SY7000

One-touch fitting (Metric size)

C4	One-touch fitting for ø4	SY3000
C6	One-touch fitting for ø6	
C4	One-touch fitting for ø4	
C6	One-touch fitting for ø6	SY5000
C8	One-touch fitting for ø8	
C8	One-touch fitting for ø8	SY7000
C10	One-touch fitting for ø10	

One-touch fitting (Inch size)

N3	One-touch fitting for ø5/32"	SY3000
N7	One-touch fitting for ø1/4"	
N3	One-touch fitting for ø5/32"	
N7	One-touch fitting for ø1/4"	SY5000
N9	One-touch fitting for ø5/16"	
N9	One-touch fitting for ø5/16"	SY7000
N11	One-touch fitting for ø3/8"	

Note) When placing an order for body ported solenoid valve as a single unit, mounting screw for manifold and gasket are not attached. Order them separately, if necessary.

■ Gasket assembly part no.

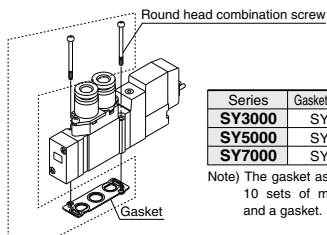

Series	Gasket assembly part no.
SY3000	SY3000-GS-1
SY5000	SY5000-GS-1
SY7000	SY7000-GS-1

Note) The gasket assembly includes 10 sets of mounting screws and a gasket.

SJ
SY
SY
S0700
S0700

SY3000: SS5Y3-20SA - Stations -

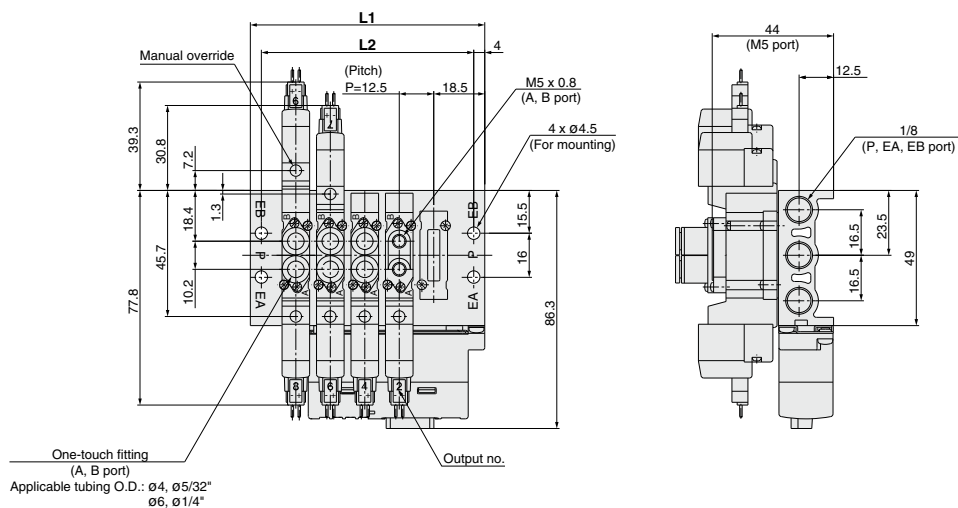

(Station n) ----- (Station 1)

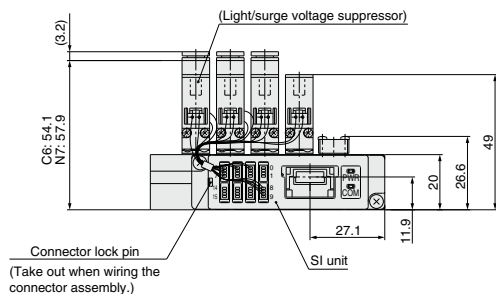

Stations n	4 stations	5	6	7	8	9	10	11	12	13	14	15	16 stations
L1	72.5	85	97.5	110	122.5	135	147.5	160	172.5	185	197.5	210	222.5
L2	64.5	77	89.5	102	114.5	127	139.5	152	164.5	177	189.5	202	214.5

SY5000: SS5Y5-20SA - Stations -

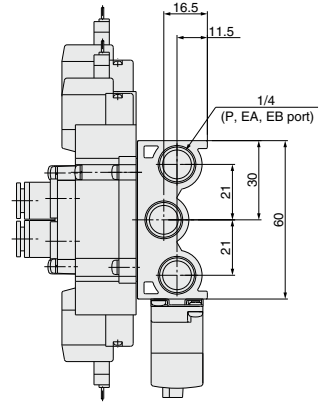
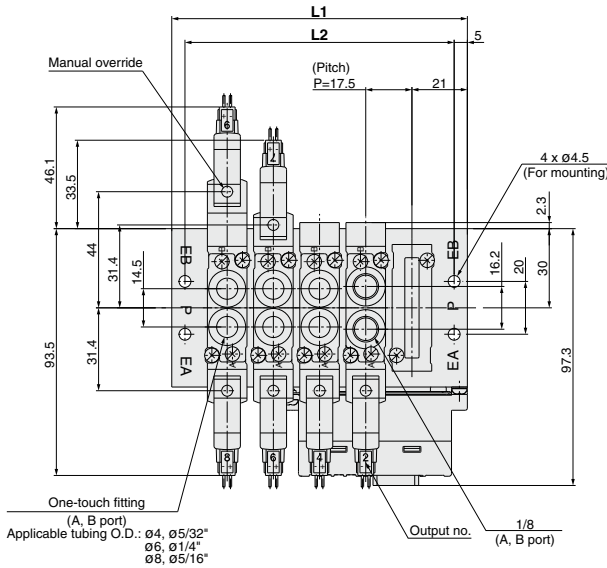

- SJ**
- SY**
- SY**
- S0700**
- S0700**

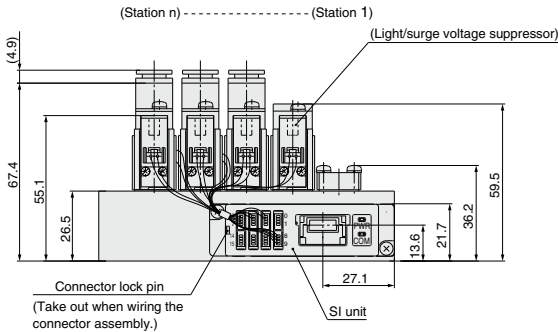

Stations n	3 stations	4	5	6	7	8	9	10	11	12	13	14	15	16 stations
L1	77	94.5	112	129.5	147	164.5	182	199.5	217	234.5	252	269.5	287	304.5
L2	67	84.5	102	119.5	137	154.5	172	189.5	207	224.5	242	259.5	277	294.5

SY7000: SS5Y7-20SA - Stations -

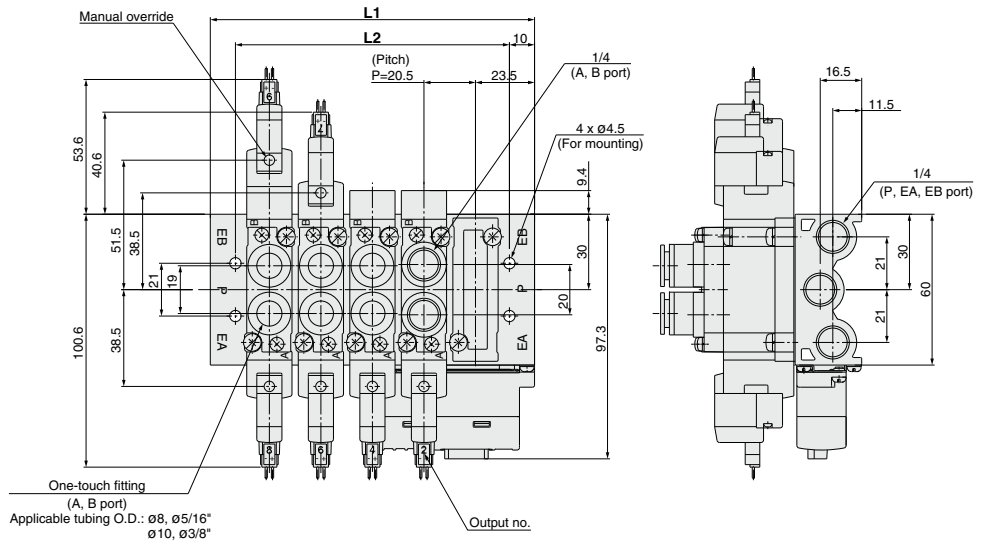

(Station n) ----- (Station 1)

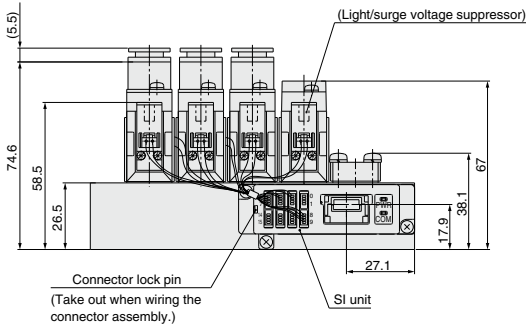

Stations n	3 stations	4	5	6	7	8	9	10	11	12	13	14	15	16 stations
L1	88	108.5	129	149.5	170	190.5	211	231.5	252	272.5	293	313.5	334	354.5
L2	68	88.5	109	129.5	150	170.5	191	211.5	232	252.5	273	293.5	314	334.5

SJ
SY
SY
S0700
S0700

Type **23SA**

EX510 Gateway-type Serial Transmission System Body Ported Manifold/Stacking Type **SY9000 Series**



How to Order Manifold

SS5Y9-23SA [] - **03** - [] - [] - []

SI unit

NII	NPN output (+COM.)
N	PNP output (-COM.)

CE-compliant

NII	—
Q	CE-compliant

Valve stations

Symbol	Stations	Note
03	3 stations	Double wiring ^{Note 1)}
⋮	⋮	
08	8 stations	
03	3 stations	Specified layout ^{Note 2)} (Compatible with 16 solenoid valves)
⋮	⋮	
16	16 stations	

- The number of the blanking plate assembly is also included.
- Note 1) Double wiring: Use of a single solenoid will result in an unused control signal. If this is not desired, order with a specified layout.
- Note 2) Specified layout: Indicate wiring specifications on the manifold specification sheet. (Note that double and 3 position valves cannot be used where single solenoid wiring has been specified.)

Option

NII	Direct mounting
D	DIN rail mounting (With DIN rail)
DO	DIN rail mounting (Without DIN rail)
D*	When a longer DIN rail is desired than the specified stations, specify the station number to be required into * mark.

P, R port thread type

NII	Rc
00F	G
00N	NPT
00T	NPTF

How to Order Manifold Assembly (Example)

Example

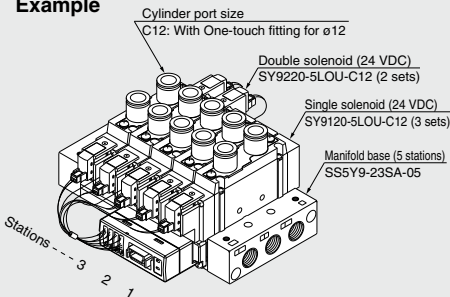

SS5Y9-23SA-05 1 set (23SA type 5-station manifold part no.)
 * **SY9120-5LOU-C12** ... 3 sets (Single solenoid part no.)
 * **SY9220-5LOU-C12** ... 2 sets (Double solenoid part no.)
 The asterisk denotes the symbol for assembly. Prefix to the part no. of the solenoid valve, etc.

Add the valve and option part number under the manifold base part number.
 When entry of part numbers becomes complicated, indicate by the manifold specification sheet. For a manifold for an EX510, the length of the lead wire for a connector assembly depends on the number of stations. Therefore, the manifold assembly is shipped with the valves (including blanking plates) and connector assembly mounted on it, as the standard specification. Be sure to specify the part nos. of the solenoid valves to be mounted.

SI unit part no.

Symbol	SI unit specifications	SI unit part no.	Page
NII	NPN output (+COM.)	EX510-S001	P.897
N	PNP output (-COM.)	EX510-S101	

Refer to page 878 and the Operation Manual for the details of EX510 Gateway-type Serial Transmission System. Please download the Operation Manual via our website, <http://www.smcworld.com>

How to Order Valves

SY9 1 20 - **5 LO Z** - **02** -

Type of actuation

1	2 position single
2	2 position double
3	3 position closed center
4	3 position exhaust center
5	3 position pressure center

Pilot specifications

NII	Internal pilot
R	External pilot

Coil specifications

NII	Standard
T	With power saving circuit

Rated voltage: 24 VDC

Light/Surge voltage suppressor

Z	With light/surge voltage suppressor
U	With light/surge voltage suppressor (non-polar type)

Note 1) Power saving circuit is only available in the "Z" type.

Note 2) When the SI unit is the PNP output (-COM.), only the "U" type is available.

Manual override

NII	Non-locking push type
D	Push-turn locking slotted type
E	Push-turn locking lever type

CE-compliant

NII	—
Q	CE-compliant

Thread type

NII	Rc
F	G
N	NPT
T	NPTF

A, B port size

Thread piping

02	1/4
03	3/8

One-touch fitting (Metric size)

C8	One-touch fitting for ø8
C10	One-touch fitting for ø10
C12	One-touch fitting for ø12

One-touch fitting (Inch size)

N9	One-touch fitting for ø5/16"
N11	One-touch fitting for ø3/8"

SJ
SY
SY
S0700
S0700

Note) When placing an order for body ported solenoid valve as a single unit, mounting screw for manifold and gasket are not attached. Order them separately, if necessary.

■ Gasket assembly part no.

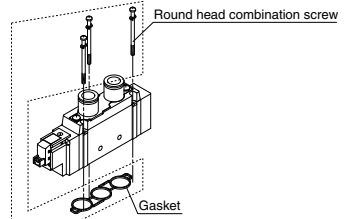

Series	Gasket assembly part no.
SY9000	SY9000-GS-1

Note) The gasket assembly includes 10 sets of mounting screws and a gasket.

SY9000: SS5Y9-23SA - Stations - (-D)

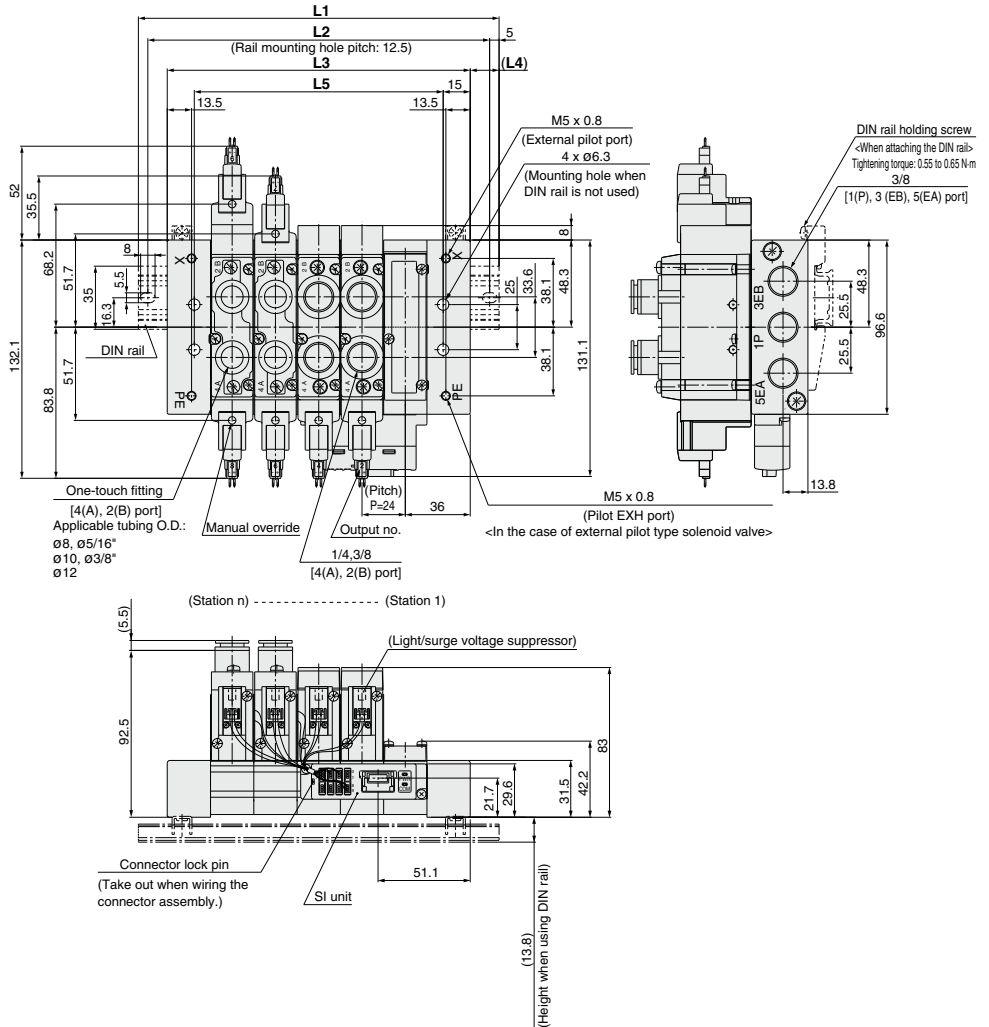

Stations n	3 stations	4	5	6	7	8	9	10	11	12	13	14	15	16 stations
L1	148	173	198	223	248	273	298	323	335.5	360.5	385.5	410.5	435.5	460.5
L2	137.5	162.5	187.5	212.5	237.5	262.5	287.5	312.5	325	350	375	400	425	450
L3	120	144	168	192	216	240	264	288	312	336	360	384	408	432
L4	14	14.5	15	15.5	16	16.5	17	17.5	12	12.5	13	13.5	14	14.5
L5	90	114	138	162	186	210	234	258	282	306	330	354	378	402

Note) In the case of direct mounting without DIN rail, total width of manifold is L3.

Manifold Option

■ Type 20, 23, 20SA, 23SA Blanking plate assembly

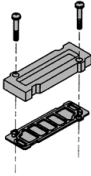

<Standard>

Series	Assembly part no.
SY3000	SY3000-26-9A
SY5000	SY5000-26-20A
SY7000	SY7000-26-22A
SY9000	SY9000-26-1A

<CE-compliant>

Series	Assembly part no.
SY3000	SY3000-26-19A-Q
SY5000	SY5000-26-1A-Q
SY7000	SY7000-26-1A-Q
SY9000	SY9000-26-1A-Q

■ Type 20P, 23P Blanking plate assembly

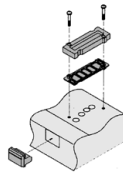

<Standard>

Series	Assembly part no.
SY3000	SY3000-26-10A
SY5000	SY5000-26-21A
SY7000	SY7000-26-23A
SY9000	SY9000-26-3A

<CE-compliant>

Series	Assembly part no.
SY3000	SY3000-26-20A-Q
SY5000	SY5000-26-3A-Q
SY7000	SY7000-26-3A-Q
SY9000	SY9000-26-3A-Q

■ Gasket assembly part no.

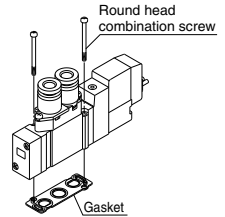

Series	Gasket assembly part no.
SY3000	SY3000-GS-1
SY5000	SY5000-GS-1
SY7000	SY7000-GS-1
SY9000	SY9000-GS-1

Note) The gasket assembly includes 10 sets of mounting screws and a gasket.

■ Individual SUP spacer assembly

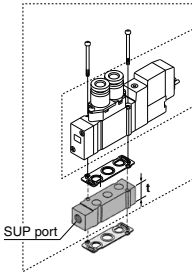

Series	Assembly part no.	Port size	t
SY3000	SY3000-38-20A(-Q)	M5 x 0.8	10.5
SY5000	SY5000-38-1+A(-Q)	1/8	15
SY7000	SY7000-38-1+A(-Q)	1/4	18
SY9000	SY9000-38-1+A(-Q)	1/4	20

Note) • The SUP port of SY3000/5000/7000 may be either on the lead wire side or on the end plate side. However, as the CE-compliant products (-Q) must be mounted in the specified direction, the port directions cannot be changed. (An assembly is shipped under the conditions shown in the figure.)
• For the SY9000, it can only be used on the end plate side.

■ Individual EXH spacer assembly

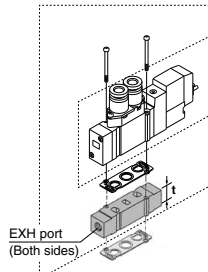

Series	Assembly part no.	Port size	t
SY3000	SY3000-39-20A(-Q)	M5 x 0.8	10.5
SY5000	SY5000-39-1+A(-Q)	1/8	15
SY7000	SY7000-39-1+A(-Q)	1/4	18
SY9000	SY9000-39-1+A(-Q)	1/4	20

Note) In case of 20P and 23P, for protection of the wiring unit section from drainage, piping at the EA port should be arranged so that it will not be directly exposed to exhaust from the valve.

■ Individual SUP spacer assembly + Individual EXH spacer assembly (Double spacer)

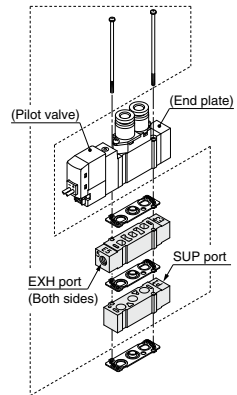

● Available x: Not available

Series	Individual SUP + Individual EXH Assemble part no.	Port size	Applicable manifold types	
			20	20P
SY3000	SY3000-120-1A(-Q)	M5 x 0.8	●	x
SY5000	SY5000-75-2+A(-Q)	1/8	●	x
SY7000	SY7000-73-3+A(-Q)	1/4	●	x

Note) The SUP spacer's port does not have an orientation. However, as the CE-compliant products (-Q) must be mounted in the specified direction, the port directions cannot be changed. As for the EXH ports, adjust the symbol "S" to the pilot valve side. Also, please make sure to connect the individual ports to protect the wiring section of the pilot valve from drainage, etc.

The individual SUP spacer and EXH spacer can be mounted either on the upper side or lower side. (The above illustration shows the condition when the product is shipped out from a factory.)

⚠ Caution

Mounting screw tightening torques

M2: 0.16 N·m
M3: 0.8 N·m
M4: 1.4 N·m

* Thread type

Nil	Rc
F	G
N	NPT
T	NPTF

⚠ Warning

When mounting a valve or spacer on the manifold base or sub-plate, etc., those mounting directions are determined. If mounted in the wrong direction, the equipment to be connected may cause malfunction. Refer to external dimensions, and then mount it.

Manifold Option

■ Connector assembly

For single solenoid (SY3000-37-81A-□-N)

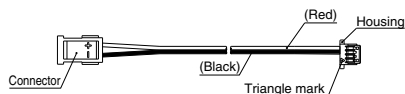

For double solenoid (SY3000-37-81A-□-□)

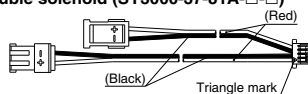

Connector assembly order no. (Can be used for the manifold without a specified layout (8 stations or less))
Integrated type

Model	Part no.	Connector mounting position
SS5Y3-20SA	SY3000-37-81A-3-N	Single : For 1 to 4 stations
	SY3000-37-81A-3-6	Double/3 position: For 1 to 4 stations
	SY3000-37-81A-2-N	Single : For 5 to 8 stations
	SY3000-37-81A-2-4	Double/3 position: For 5 to 8 stations
SS5Y5-20SA	SY3000-37-81A-3-N	Single : For 1 to 8 stations
	SY3000-37-81A-3-6	Double/3 position: For 1 to 8 stations
SS5Y7-20SA	SY3000-37-81A-3-N	Single : For 1 to 4 stations
	SY3000-37-81A-3-6	Double/3 position: For 1 to 4 stations
	SY3000-37-81A-4-N	Single : For 5 to 8 stations
	SY3000-37-81A-4-7	Double/3 position: For 5 to 8 stations

Note) The above is for the station addition or maintenance. When ordering a connector assembly separately, a number would not be printed on the connector.

■ Connector assembly

SY3000-37-80A-□

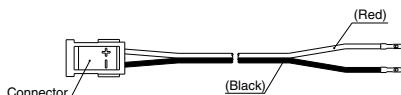

■ Housing (8 pcs/set)

SY3000-44-3A



Connector assembly order no. (Can be used for the manifold with a specified layout)

Model	Part no.	Connector mounting position
SS5Y3-20SA	SY3000-37-80A-3	For A side
	SY3000-37-80A-6	For B side
	SY3000-37-80A-4	For A side
	SY3000-37-80A-7	For B side
SS5Y5-20SA	SY3000-37-80A-3	For A side
	SY3000-37-80A-6	For B side
	SY3000-37-80A-7	For A side
	SY3000-37-80A-9	For B side
SS5Y7-20SA	SY3000-37-80A-4	For A side
	SY3000-37-80A-7	For B side
	SY3000-37-80A-8	For A side
	SY3000-37-80A-11	For B side
SS5Y9-23SA	SY3000-37-80A-6	For A side
	SY3000-37-80A-11	For B side
	SY3000-37-80A-9	For A side
	SY3000-37-80A-14	For B side
	SY3000-37-80A-13	For A side
	SY3000-37-80A-18	For B side

Note 1) The above is for station addition or maintenance. When ordering a connector assembly separately, a number will not be printed on the connector.

Note 2) After inserting the connector assembly into the housing, be sure to confirm that the lead wire will not come off by lightly pulling the wire. Furthermore, do not reuse the lead wire after it has been inserted and removed.

Note 3) Wiring is set longer than the actual wiring distance.

Manifold Option

■ SUP blocking disk (For SY9000)

By installing a SUP blocking disk in the pressure supply passage of a manifold valve, it is possible to supply two or more different high and low pressures to one manifold.



Series	Part no.
SY9000	SY9000-61-2A

■ EXH blocking disk (For SY9000)

By installing an EXH blocking disk in the exhaust passage of a manifold valve, it is possible to divide the valve's exhaust so that it does not affect another valve. (Two blocking disks are needed to divide both exhausts.)



Series	Part no.
SY9000	SY9000-61-2A

■ Label for blocking disk (For SY9000)

The labels shown below are used on manifold stations containing SUP/EXH blocking disk(s) to show their location. (3 pcs. each)

VZ3000-123-1A

Label for SUP block disk

Label for EXH block disk

Label for SUP/EXH block disk



* When a block disk is concurrently ordered by specifying on the manifold specification sheet, etc., a label will be stuck on the position where block disk is mounted.

■ DIN Rail Dimensions/Weight for SY9000

VZ1000-11-4-□

Refer to L dimensions

* Fill in □ with an appropriate no. listed on the table of DIN rail dimensions shown below.

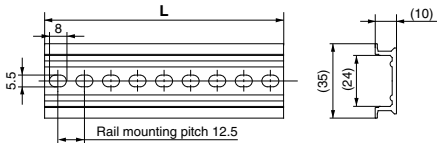

No.	0	1	2	3	4	5	6	7	8	9
L Dimension	98	110.5	123	135.5	148	160.5	173	185.5	198	210.5
Weight (g)	24.8	28	31.1	34.3	37.4	40.6	43.8	46.9	50.1	53.3
No.	10	11	12	13	14	15	16	17	18	19
L Dimension	223	235.5	248	260.5	273	285.5	298	310.5	323	335.5
Weight (g)	56.4	59.6	62.7	65.9	69.1	72.2	75.4	78.6	81.7	84.9
No.	20	21	22	23	24	25	26	27	28	29
L Dimension	348	360.5	373	385.5	398	410.5	423	435.5	448	460.5
Weight (g)	88	91.2	94.4	97.5	100.7	103.9	107	110.2	113.3	116.5

Note) For DIN rail, refer to page 640.

Refer to L1 dimension on pages 447, 456 and 466 for lengths that correspond to the number of manifold stations.

■ Cable assembly (For 20P, 23P)

AXT100-FC26-1 to 3

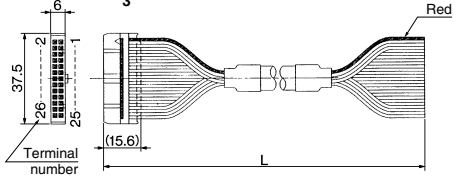

SJ
SY
SY
S0700
S0700

Connector Assembly for Flat Ribbon Cables

Cable length (L)	Assembly part no.	Note
1.5 m	AXT100-FC26-1	Cable 26 core x 28 AWG
3 m	AXT100-FC26-2	
5 m	AXT100-FC26-3	

* For other commercial connectors, use a 26 pins with strain relief conforming to MIL-C-83503.

Connector manufacturers' example

- HIROSE ELECTRIC CO., LTD.
- Japan Aviation Electronics Industry, Limited
- 3M Japan Limited
- J.S.T. Mfg. Co., Ltd.
- Fujitsu Limited

■ Plug

These are inserted in unused cylinder ports and SUP, EXH ports. Purchasing order is available in units of 10 pieces.

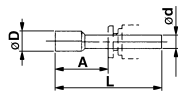

Dimensions

Applicable fittings size od	Model	A	L	D
4	KQ2P-04	16	32	6
6	KQ2P-06	18	35	8
8	KQ2P-08	20.5	39	10
10	KQ2P-10	22	43	12
12	KQ2P-12	24	44.5	14
1/8"	KQ2P-01	16	31.5	5
5/32"	KQ2P-03	16	32	6
1/4"	KQ2P-07	18	35	8.5
5/16"	KQ2P-09	20.5	39	10
3/8"	KQ2P-11	22	43	11.5

How to Increase Manifold Bases (SY9000 series only) Manifold case can be added at any location.

When a type 23 manifold base is added, tension bolts as well as manifold block assembly will be required. Order the tension bolt suitable for the stations after a station was increased (decreased), since the length of a tension bolt differs by the number of stations. (For changing the number of stations for a type 23P manifold, wiring unit for the stations and lead assembly will be required.)

- 1 Loosen the tension bolts ⑤ connecting the manifold base, and pull out both of 2 tension bolts.
(When equipped with a DIN rail, loosen one DIN rail holding screw on either U side or D side.)
- 2 Separate the blocks at the location where station expansion is desired.
- 3 Mount additional manifold block assembly.
- 4 Press block-to-block so that there's no gap. After connection, insert a tension bold for desired stations and then tighten it.

⚠ Caution (Tightening torque: 2.9 N·m)
(When equipped with a DIN rail, be sure to tighten the DIN rail holding screws after tightening the tension bolts. Tightening torque: 1.4 N·m)

⚠ Caution

1. Be sure to shut off the power and air supplies before disassembly. Furthermore, since air may remain inside the actuator, piping and manifold, confirm that the air is completely exhausted before performing any work.
2. When disassembly and assembly are performed, air leakage may result if connections between blocks and tightening of the end block's holding screw, is inadequate.
3. By adding wiring unit assembly to type 23 manifold, it can be changed to type 23P manifold, too.

Body Ported Manifold Exploded View, 23/23P Common

As for body ported manifold, it is available only for SY9000 series to disassemble or increase the manifold.

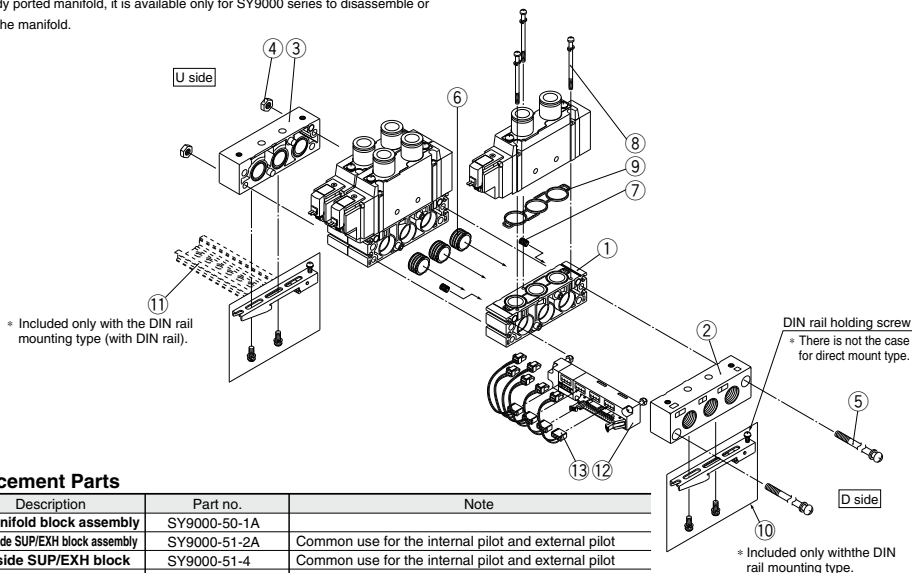

Replacement Parts

No.	Description	Part no.	Note
1	Manifold block assembly	SY9000-50-1A	
2	D side SUP/EXH block assembly	SY9000-51-2A	Common use for the internal pilot and external pilot
3	U side SUP/EXH block	SY9000-51-4	Common use for the internal pilot and external pilot
4	Hexagon nut	SY9000-25-1	M5 x 0.8
5	Tension bolt	SY9000-23-□	Since □ at the end of part number corresponds with the number of stations, fill in the same number as the number of stations.
6	Bush assembly	SY9000-61-1A	Included in the Manifold block assembly and the D side SUP/EXH block assembly.
7	Bush assembly	SY9000-61-3A	Included in the Manifold block assembly and the D side SUP/EXH block assembly.
8	Round head combination screw	SY9000-18-2	Included in the Manifold block assembly.
9	Manifold gasket	SY9000-11-1	Included in the Manifold block assembly.
10	Clamp sub assembly	SY9000-29-1A	
11	DIN rail	VZ1000-11-4-□	Refer to page 469.
12	Wiring unit assembly	SY9000-36-□A	Since □ in part number corresponds with the number of stations, fill in the number of stations (4 to 12).
13	Connector assembly	SY9000-37-□□	Refer to page 455.

SJ
SY
SY
S0700
S0700

5 Port Solenoid Valve Body Ported Manifold Cassette Type

Note) AC-type models that are CE-compliant have DIN terminals only.



Type **60**

SY3000/5000/7000 Series

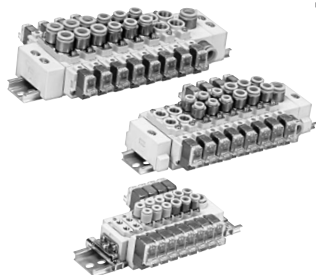

How to Order

SS5Y **3** - 60 - **05** **D** - [] - []

Series	
3	SY3000
5	SY5000
7	SY7000

Valve stations	
02	2 stations
:	:
20	20 stations

CE-compliant

NII	—
Q	CE-compliant

Note) AC-type models that are CE-compliant have DIN terminals only.

Option

When a DIN rail longer than standard is required, enter the number of manifold stations that corresponds with the length of DIN rail needed. Max. 20 stations

SUP/EXH block assembly mounting position

Symbol	Mounting position	Applicable stations
U	U side	2 to 10 stations
D	D side	2 to 20 stations
B	Both sides	2 to 20 stations
M	Special location	

* For special specifications, indicate separately by the manifold specification sheet.

How to Order Manifold Assembly (Example)

Example

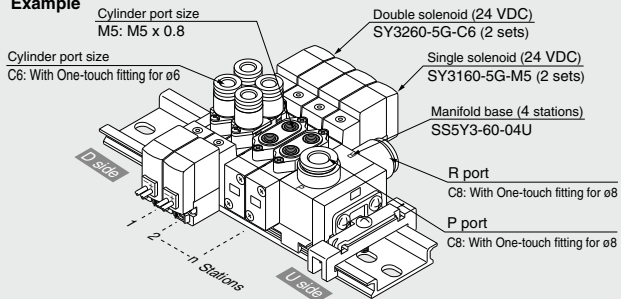

SS5Y3-60-04U 1 set (Type 60, 4-station manifold base part no.)
 * SY3260-5G-C6 2 sets (Double solenoid part no.)
 * SY3160-5G-M5 2 sets (Single solenoid part no.)

↳ The asterisk denotes the symbol for assembly. Prefix it to the part nos. of the solenoid valve, etc.

Add the valve and option part number under the manifold base part number. In the case of complex arrangement, specify them on the manifold specification sheet.

Manifold Specifications

Model	SS5Y3-60(-Q)		SS5Y5-60(-Q)		SS5Y7-60(-Q)	
Applicable valve	SY3□60		SY5□60		SY7□60	
Manifold type	Stacking type/DIN rail mounted					
P (SUP)/R (EXH)	Common SUP/Common EXH					
Valve stations	2 to 20 stations ^{Note 1)}					
A, B port location	Valve					
Port size	P, R port	C8 (One-touch fitting for ø8) M5 x 0.8	C10 (One-touch fitting for ø10) 1/8	C12 (One-touch fitting for ø12) 1/4		
	A, B port	C4 (One-touch fitting for ø4) C6 (One-touch fitting for ø6)	C4 (One-touch fitting for ø4) C6 (One-touch fitting for ø6) C8 (One-touch fitting for ø8)	C8 (One-touch fitting for ø8) C10 (One-touch fitting for ø10)		
Manifold base weight W (g) ^{Note 2)} (n: Number of SUP/EXH blocks, m: Weight of DIN rail)		W = 13n + m + 36	W = 41.2n + m + 77.6	W = 65.4n + m + 128.2		

Note 1) In cases such as those where many valves are operated simultaneously, use "-[station]B (SUP/EXH block on both sides)", applying pressure to the P ports on both sides and exhausting from the R ports on both sides.

Note 2) For DIN rail weight, refer to page 478.

Flow Rate Characteristics

Model	Port size		Flow rate characteristics					
	1,5/3 (P,R)	4,2 (A,B)	1 → 4/2(P → A/B)			4/2 → 5/3(A/B → R)		
			C (dm ³ /(s·bar))	b	Cv	C (dm ³ /(s·bar))	b	Cv
SS5Y3-60(-Q)	C8	M5	0.55	0.29	0.14	0.72	0.24	0.18
		C4	0.57	0.24	0.14	0.71	0.20	0.17
		C6	0.68	0.28	0.17	0.77	0.24	0.19
SS5Y5-60(-Q)	C10	1/8	1.8	0.24	0.44	2.1	0.17	0.47
		C6	1.5	0.30	0.37	2.0	0.16	0.46
		C8	1.8	0.20	0.45	2.2	0.17	0.50
SS5Y7-60(-Q)	C12	1/4	3.7	0.25	0.96	3.8	0.19	0.94
		C8	3.2	0.26	0.81	4.0	0.18	0.96
		C10	3.7	0.28	0.98	4.1	0.19	1.0

Note) The value is for manifold base with 5 stations and individually operated 2 position type.

SJ

SY

SY

S0700

S0700



How to Order Valve

Note) AC-type models that are CE-compliant have DIN terminals only.

SY 3 1 60 - **5 L** - **C6**

Series

3	SY3000
5	SY5000
7	SY7000

Type of actuation

1	2 position single (A)4 2(B)	
	(EA)5 1 3(EB) (P)	
2	2 position double (A)4 2(B)	
	(EA)5 1 3(EB) (P)	
3	3 position closed center (A)4 2(B)	
	(EA)5 1 3(EB) (P)	
4	3 position exhaust center (A)4 2(B)	
	(EA)5 1 3(EB) (P)	
5	3 position pressure center (A)4 2(B)	
	(EA)5 1 3(EB) (P)	

Coil specifications

Nil	Standard
T	With power saving circuit (24 VDC, 12 VDC only)

* Power saving circuit is not available in the case of D, Y, DO, YO or W□ type.

Rated voltage

For DC	
5	24 VDC
6	12 VDC
V	6 VDC
S	5 VDC
R	3 VDC

For AC (50/60Hz)

1	100 VAC
2	200 VAC
3	110 VAC [115 VAC]
4	220 VAC [230 VAC]

* DC specifications of type D, Y, DO and YO is only available with 12 and 24 VDC.

* D, Y, DO and YO only available for SY5000, SY7000.

* For type W□, DC voltage is only available.

Note) AC-type models that are CE-compliant have DIN terminals only.

Made to Order

Nil	—
X20	Body ported external pilot (Refer to page 624.)
X90	Main valve fluoro rubber (Refer to page 624.)

A, B port size Thread piping

Symbol	Port size	Applicable series
M5	M5 x 0.8	SY3000
O1	1/8	SY5000
O2	1/4	SY7000

Thread type

Nil	Rc
F	G
N	NPT
T	NPTF

* Except for M5

One-touch fitting (Metric size)

Symbol	Port size	Applicable series
C4	One-touch fitting for ø4	SY3000
C6	One-touch fitting for ø6	SY3000
C4	One-touch fitting for ø4	SY5000
C6	One-touch fitting for ø6	SY5000
C8	One-touch fitting for ø8	SY5000
C8	One-touch fitting for ø8	SY7000
C10	One-touch fitting for ø10	SY7000

One-touch fitting (Inch size)

Symbol	Port size	Applicable series
N3	One-touch fitting for ø5/32"	—
N7	One-touch fitting for ø1/4"	SY3000
N3	One-touch fitting for ø5/32"	—
N7	One-touch fitting for ø1/4"	SY5000
N9	One-touch fitting for ø5/16"	—
N9	One-touch fitting for ø5/16"	SY7000
N11	One-touch fitting for ø3/8"	SY7000

Manual override

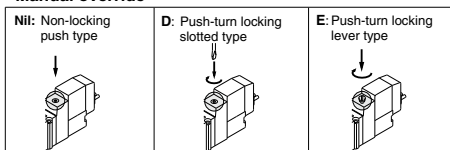

CE-compliant

Nil	—
Q	CE-compliant

Note) AC-type models that are CE-compliant have DIN terminals only.

Light/Surge voltage suppressor

Electrical entry for G, H, L, M, W

Nil	Without light/surge voltage suppressor
S	With light/surge voltage suppressor
Z	With light/surge voltage suppressor
R	With surge voltage suppressor (Non-polar type)
U	With light/surge voltage suppressor (Non-polar type)

* For AC voltage valves there is no "S" option. It is already built-in to the rectifier circuit.
* Power saving circuit is only available in the "Z" type.

Electrical entry for D, Y, (SY5000/7000 only)

Nil	Without light/surge voltage suppressor
S	With surge voltage suppressor (Non-polar type)
Z	With light/surge voltage suppressor (Non-polar type)

* DOZ and YOZ are not available.
* For AC voltage valves there is no "S" option. It is already built-in to the rectifier circuit.

Electrical entry

	24, 12, 6, 5, 3 VDC/100, 110, 200, 220 VAC				24, 12 VDC/100, 110, 200, 220 VAC	24, 12, 6, 5, 3 VDC
	Grommet	L plug connector	M plug connector		DIN terminal	M8 connector
G: Lead wire length 300 mm	L: With lead wire (Length 300 mm)	M: With lead wire (Length 300 mm)	MN: Without lead wire	(SY5000, 7000) D, Y: With connector	WO: Without connector cable	
H: Lead wire length 600 mm	LN: Without lead wire	LO: Without connector	MO: Without connector	DO, YO: Without connector	W□: With connector cable (Note 2)	
Manifold mounting	SY3000 ●	SY5000 ●	SY7000 ●	— (Note 1)	●	
CE-compliant	DC ●	AC —	—	●	—	

Note 1) The DIN terminal of the SY3000 series cannot be mounted on a standard manifold. For details, refer to page 639.
Note 2) Enter the cable length symbols in □. Please be sure to fill in the blank referring to page 642.

Note 3) When ordering single unit of the cassette type solenoid valve, the bushing assembly is included.

* LN, MN type: with 2 sockets.

* "Y" type is a DIN terminal conforming to EN-175301-803C (former DIN43650C). For details, refer to page 638.

* For connector cable of M8 connector, refer to page 641.

* M8 connector conforming to IEC60947-5-2 standard is also available. Refer to page 623 for details.

* Refer to page 638 for the lead wire length of L and M plug connectors.

* Refer to page 639 for the connector assembly with cover for L and M plug connectors.

Specifications

Series		SY3000	SY5000	SY7000
Fluid		Air		
Internal pilot Operating pressure range (MPa)	2 position single	0.15 to 0.7		
	2 position double	0.1 to 0.7		
	3 position	0.2 to 0.7		
Ambient and fluid temperature (°C)		Max. 50		
Max. operating frequency (Hz)	2 position double	10	5	5
	3 position	3	3	3
Manual override (Manual operation)		Non-locking push type, Push-turn locking slotted type, Push-turn locking lever type		
Pilot exhaust method		Common exhaust type for main and pilot valve		
Lubrication		Not required		
Mounting position		Unrestricted		
Impact/Vibration resistance <small>Note</small>		150/30		
Enclosure		Dust proof (+ DIN terminal, M8 connector: IP65)		

Note) Impact resistance: No malfunction occurred when it is tested in the axial direction and at the right angles to the main valve and armature in both energized and de-energized states every once for each condition.

Vibration resistance: No malfunction occurred in a one-sweep test between 45 and 2000 Hz.

Test was performed at both energized and de-energized states in the axial direction and at the right angles to the main valve and armature. (Values in the initial stage)

* Based on IEC60529

Solenoid Specifications

Electrical entry		Grommet (G), (H) L plug connector (L) M plug connector (M) DIN terminal (D), (Y) M8 connector (W)	
Coil rated voltage (V)	DC	24, 12, 6, 5, 3	
	AC 50/60 Hz	24, 12	
Allowable voltage fluctuation		±10% of rated voltage *	
Power consumption (W)	DC	Standard	0.35 [With indicator light: 0.4 (DIN terminal with indicator light: 0.45)]
		With power saving circuit	0.1 (With indicator light only) * [Starting 0.4, Holding 0.1]
Apparent power (VA) *	AC	100 V	0.78 (With indicator light: 0.81) 0.78 (With indicator light: 0.87)
		110 V [115 V]	0.86 (With indicator light: 0.89) 0.86 (With indicator light: 0.97) 0.94 (With indicator light: 0.97) 0.94 (With indicator light: 1.07)
		200 V	1.18 (With indicator light: 1.22) 1.15 (With indicator light: 1.30)
		220 V [230 V]	1.30 (With indicator light: 1.34) 1.27 (With indicator light: 1.46) 1.42 (With indicator light: 1.46) 1.39 (With indicator light: 1.60)
Surge voltage suppressor		Diode (Varistor is for DIN terminal and non-polar)	
Indicator light		LED (AC of DIN connector is neon light.)	

* In common between 110 VAC and 115 VAC, and between 220 VAC and 230 VAC.

* For 115 VAC and 230 VAC, the allowable voltage is -15% to +5% of rated voltage.

* For details, refer to page 636.

Response Time

Note) Based on dynamic performance test, JIS B 8375-1981. (Coil temperature: 20°C, at rated voltage)

SY3000

Type of actuation	Response time (ms) (at the pressure of 0.5 MPa)		
	Without surge voltage suppressor	With surge voltage suppressor	
		S, Z type	R, U type
2 position single	12 or less	15 or less	12 or less
2 position double	10 or less	13 or less	10 or less
3 position	15 or less	20 or less	16 or less

SY5000

Type of actuation	Response time (ms) (at the pressure of 0.5 MPa)		
	Without surge voltage suppressor	With surge voltage suppressor	
		S, Z type	R, U type
2 position single	19 or less	26 or less	19 or less
2 position double	18 or less	22 or less	18 or less
3 position	32 or less	38 or less	32 or less

SY7000

Type of actuation	Response time (ms) (at the pressure of 0.5 MPa)		
	Without light/surge voltage suppressor	With light/surge voltage suppressor	
		S, Z type	R, U type
2 position single	31 or less	38 or less	33 or less
2 position double	27 or less	30 or less	28 or less
3 position	50 or less	56 or less	50 or less

SJ

SY

SY

S0700

S0700

Weight

SY3000 series

Valve model	Type of actuation		Port size A, B	Weight (g)		
				Gro-mmet	L/M plug connector	M8 Connector
SY3□60-□-M5	2 position	Single	M5 x 0.8	49	51	55
		Double		70	73	81
	3 position	Closed center		73	76	84
		Exhaust center Pressure center				
SY3□60-□-C4	2 position	Single	C4 (One-touch fitting for ø4)	62	61	65
		Double		80	83	91
	3 position	Closed center		82	86	94
		Exhaust center Pressure center				
SY3□60-□-C6	2 position	Single	C6 (One-touch fitting for ø6)	55	57	61
		Double		76	79	87
	3 position	Closed center		78	82	90
		Exhaust center Pressure center				

Note) [] : denotes normal position.

SY7000 series

Valve model	Type of actuation		Port size A, B	Weight (g)			
				Gro-mmet	L/M plug connector	DIN terminal	M8 Connector
SY7□60-□-02	2 position	Single	1/4	103	105	126	109
		Double		125	128	170	136
	3 position	Closed center		133	136	178	144
		Exhaust center Pressure center					
SY7□60-□-C8	2 position	Single	C8 (One-touch fitting for ø8)	138	139	160	143
		Double		160	163	205	171
	3 position	Closed center		168	171	213	179
		Exhaust center Pressure center					
SY7□60-□-C10	2 position	Single	C10 (One-touch fitting for ø10)	123	125	146	129
		Double		145	149	191	157
	3 position	Closed center		153	157	199	165
		Exhaust center Pressure center					

SY5000 series

Valve model	Type of actuation		Port size A, B	Weight (g)			
				Gro-mmet	L/M plug connector	DIN terminal	M8 Connector
SY5□60-□-01	2 position	Single	1/8	67	69	90	71
		Double		91	94	136	102
	3 position	Closed center		97	100	142	108
		Exhaust center Pressure center					
SY5□60-□-C4	2 position	Single	C4 (One-touch fitting for ø4)	91	93	114	97
		Double		113	116	158	124
	3 position	Closed center		119	122	164	130
		Exhaust center Pressure center					
SY5□60-□-C6	2 position	Single	C6 (One-touch fitting for ø6)	86	88	109	92
		Double		108	111	153	119
	3 position	Closed center		114	117	159	125
		Exhaust center Pressure center					
SY5□60-□-C8	2 position	Single	C8 (One-touch fitting for ø8)	78	80	101	84
		Double		100	103	145	111
	3 position	Closed center		106	109	151	117
		Exhaust center Pressure center					

Manifold Option

■ Individual SUP block assembly

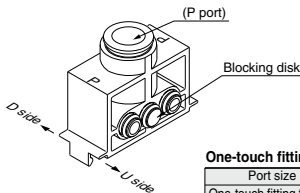

One-touch fitting (Metric size)

Port size	Assembly part no.	Applicable series
One-touch fitting for ø6	SY3000-54-2C(-Q)	SY3000
One-touch fitting for ø8	SY3000-54-1C(-Q)	SY3000
One-touch fitting for ø10	SY5000-54-1C(-Q)	SY5000
One-touch fitting for ø12	SY7000-54-1C(-Q)	SY7000

One-touch fitting (Inch size)

Port size	Assembly part no.	Applicable series
One-touch fitting for ø5/16"	SY3000-54-3C(-Q)	SY3000
One-touch fitting for ø3/8"	SY5000-54-2C(-Q)	SY5000
One-touch fitting for ø3/8"	SY7000-54-3C(-Q)	SY7000

■ Individual EXH block assembly

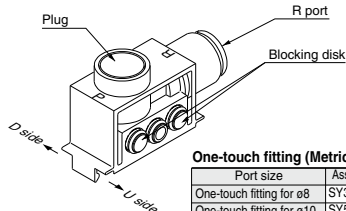

One-touch fitting (Metric size)

Port size	Assembly part no.	Applicable series
One-touch fitting for ø6	SY3000-55-1B(-Q)	SY3000
One-touch fitting for ø10	SY5000-55-1B(-Q)	SY5000
One-touch fitting for ø12	SY7000-55-1B(-Q)	SY7000

One-touch fitting (Inch size)

Port size	Assembly part no.	Applicable series
One-touch fitting for ø5/16"	SY3000-55-2B(-Q)	SY3000
One-touch fitting for ø3/8"	SY5000-55-2B(-Q)	SY5000
One-touch fitting for ø3/8"	SY7000-55-3B(-Q)	SY7000

[When supplying the manifold with 2 different supply pressures.]

Specify arrangement of individual SUP block assembly on the manifold specification sheet. (When using SSSY□-60-□□□, blocking disk is assembled on D side.)

<Manifold model no.: SSSY $\frac{3}{8}$ -60-□□□>

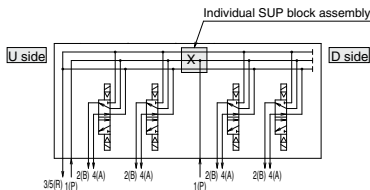

[When 2 different EXH passages are required.]

Specify arrangement of individual EXH block assembly on the manifold specification sheet. (When using SSSY□-60-□□□, blocking disk is assembled on D side.)

<Manifold model no.: SSSY $\frac{3}{8}$ -60-□□□>

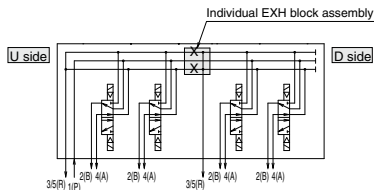

[When a different supply pressure is required for only a middle valve.]

Specify arrangement of individual SUP block assembly and SUP blocking disk on the manifold specification sheet.

(Applicable manifold model no.: SSSY□-60-□□B)

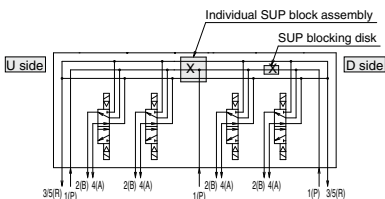

[When a separate exhaust passage is needed on only a middle valve.]

Specify arrangement of individual EXH block assembly and EXH blocking disk on the manifold specification sheet.

(Applicable manifold model no.: SSSY□-60-□□B)

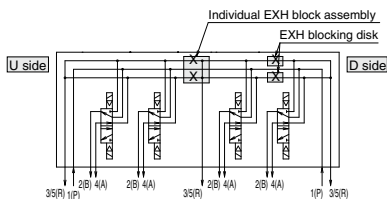

Manifold Option

■ SUP blocking disk

By installing a SUP blocking disk in the pressure supply passage of a manifold valve, it is possible to supply two or more different high and low pressures to one manifold. (This is the same block disk used with the individual SUP block assembly.)



Series	Part no.
SY3000	SY3000-52-6A
SY5000	SY5000-52-4A
SY7000	SY7000-70-2A

■ EXH blocking disk

By installing an EXH blocking disk in the exhaust passage of a manifold valve, it is possible to divide the valve's exhaust so that it does not affect another valve. (Two blocking disks are needed to separate both EXH passages. It is the same block disk that is used in the individual EXH block assembly.)



Series	Part no.
SY3000	SY3000-52-6A
SY5000	SY5000-52-4A
SY7000	SY7000-70-2A

■ Label for block disk

The labels shown below are used on manifold stations containing SUP/EXH blocking disk(s) to show their location. (3 pcs. each)

VZ3000-123-1A

Label for SUP block disk

Label for EXH block disk

Label for SUP/EXH block disk



* When a block disk is concurrently ordered by specifying on the manifold specification sheet, etc., a label will be stuck on the position where block disk is mounted.

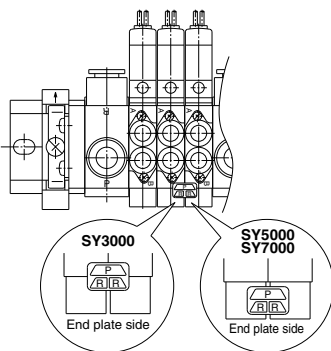

■ Silencer with One-touch fitting

The silencer plugs directly into the One-touch fittings of the manifold.

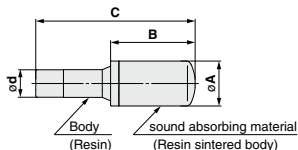

Series	Model	Effective area mm ²	A	B	C
SY3000 (for ø8)	AN15-C08	20	ø13	20	45
SY5000 (for ø10)	AN20-C10	30	ø16.5	30.5	57.5
SY7000 (for ø12)	AN30-C12	41	ø20	43.5	71.5

■ Plug

These are inserted in unused cylinder ports and SUP, EXH ports. Purchasing order is available in units of 10 pieces.

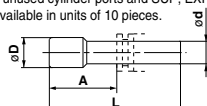

Dimensions

Applicable fittings size ød	Model	A	L	D
4	KQ2P-04	16	32	6
6	KQ2P-06	18	35	8
8	KQ2P-08	20.5	39	10
10	KQ2P-10	22	43	12
12	KQ2P-12	24	45.5	14
5/32"	KQ2P-03	16	32	6
1/4"	KQ2P-07	18	35	8.5
5/16"	KQ2P-09	20.5	39	10
3/8"	KQ2P-11	22	43	11.5

■ DIN Rail Dimensions/Weight for SY3000/5000

VZ1000-11-1-□

Refer to the L dimension tables

* Enter a number from the DIN rail dimension table below in them.

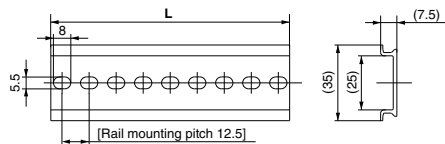

No.	0	1	2	3	4	5	6	7	8	9
L dimension	98	110.5	123	135.5	148	160.5	173	185.5	198	210.5
Weight (g)	17.6	19.9	22.1	24.4	26.6	28.9	31.1	33.4	35.6	37.9

No.	10	11	12	13	14	15	16	17	18	19
L dimension	223	235.5	248	260.5	273	285.5	298	310.5	323	335.5
Weight (g)	40.1	42.4	44.6	46.9	49.1	51.4	53.6	55.9	58.1	60.4

No.	20	21	22	23	24	25	26	27	28	29
L dimension	348	360.5	373	385.5	398	410.5	423	435.5	448	460.5
Weight (g)	62.6	64.9	67.1	69.4	71.6	73.9	76.1	78.4	80.6	82.9

■ DIN Rail Dimensions/Weight for SY7000

VZ1000-11-4-□

Refer to the L dimension tables

* Enter a number from the DIN rail dimension table below in them.

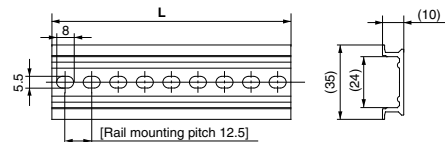

No.	0	1	2	3	4	5	6	7	8	9
L dimension	98	110.5	123	135.5	148	160.5	173	185.5	198	210.5
Weight (g)	24.8	28	31.1	34.3	37.4	40.6	43.8	46.9	50.1	53.3

No.	10	11	12	13	14	15	16	17	18	19
L dimension	223	235.5	248	260.5	273	285.5	298	310.5	323	335.5
Weight (g)	56.4	59.6	62.7	65.9	69.1	72.2	75.4	78.6	81.7	84.9

No.	20	21	22	23	24	25	26	27	28	29
L dimension	348	360.5	373	385.5	398	410.5	423	435.5	448	460.5
Weight (g)	88	91.2	94.4	97.5	100.7	103.9	107	110.2	113.3	116.5

Note) For DIN rail mounting, refer to page 640.

Construction

SY series

Symbol

2 position single

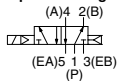

2 position single

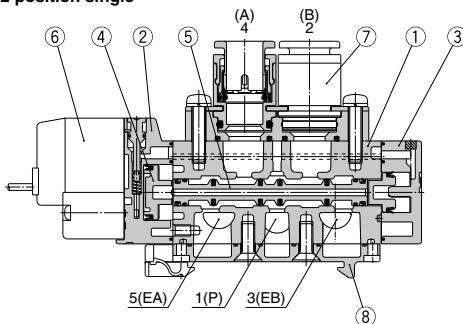

Symbol

2 position double

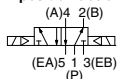

2 position double

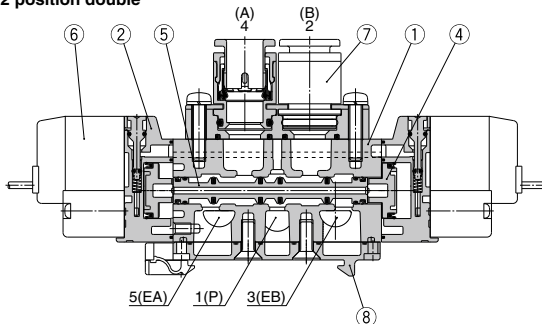

Symbol

3 position closed center

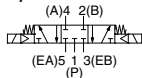

3 position exhaust center

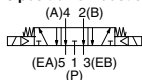

3 position pressure center

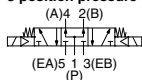

3 position closed center / exhaust center / pressure center

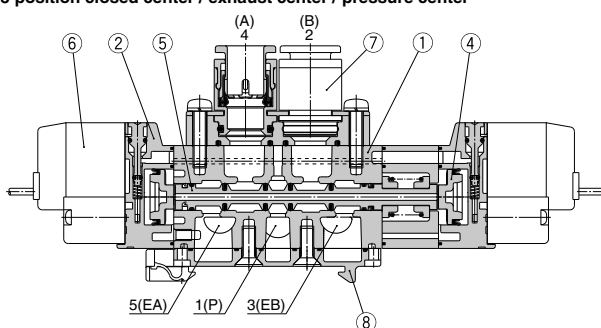

(This figure shows a closed center type.)

Component Parts

No.	Description	Material	Note
1	Body	Aluminum die-casted SY3000; Zinc die-casted	White
2	Adapter plate	Resin	White
3	End plate	Resin	White
4	Piston	Resin	—
5	Spool valve assembly	Aluminum/H-NBR	—

Replacement Parts

No.	Description	No.
6	Pilot valve assembly	Refer to "How to Order Pilot Valve Assembly" on page 629.
7	Port block assembly	Refer to "How to Order Port Block Assembly" on page 629.
8	Bottom cover assembly ^(Note)	SY3000-41-2A (with screw, gasket) SY5000-41-2A (with screw, gasket)

Note) There is no bottom cover assembly available for SY7000.

SJ

SY

SY

S0700

S0700

Dimensions

[]: AC

SS5Y3-60- Stations U

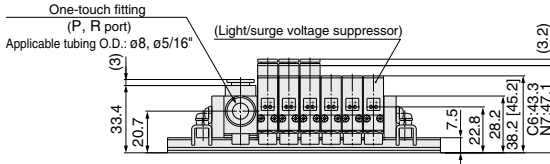
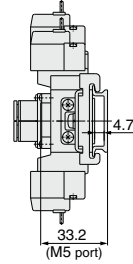
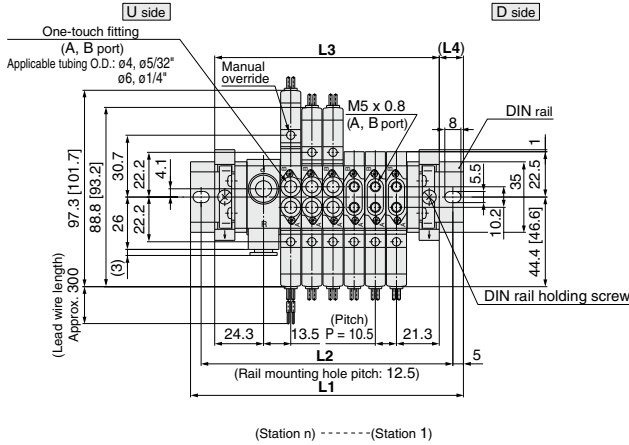

Stations	2 stations	3	4	5	6	7	8	9	10 stations
L1	98	110.5	123	135.5	135.5	148	160.5	173	185.5
L2	87.5	100	112.5	125	125	137.5	150	162.5	175
L3	69.5	80	90.5	101	111.5	122	132.5	143	153.5
L4	14	15	16	17	12	13	14	15	16

SS5Y3-60- Stations D

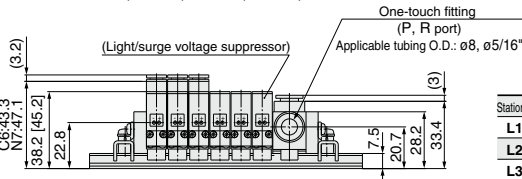
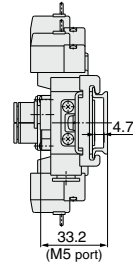
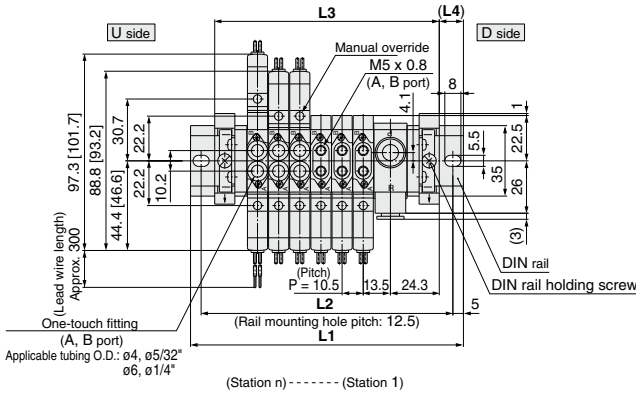

Stations	2 stations	3	4	5	6	7	8	9	10 stations
L1	98	110.5	123	135.5	135.5	148	160.5	173	185.5
L2	87.5	100	112.5	125	125	137.5	150	162.5	175
L3	69.5	80	90.5	101	111.5	122	132.5	143	153.5
L4	14	15	16	17	12	13	14	15	16

SS5Y3-60-Stations B

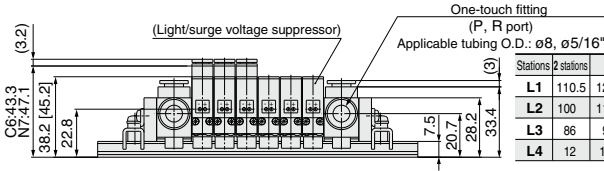
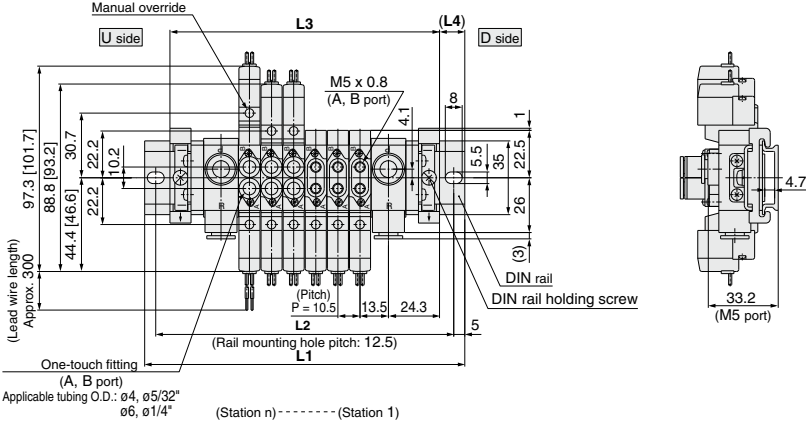

Stations	2 stations	3	4	5	6	7	8	9	10 stations
L1	110.5	123	135.5	148	160.5	173	173	185.5	198
L2	100	112.5	125	137.5	150	162.5	162.5	175	187.5
L3	86	96.5	107	117.5	128	138.5	149	159.5	170
L4	12	13	14	15	16	17	12	13	14

Stations	11 stations	12	13	14	15	16	17	18	19	20 stations
L1	210.5	223	235.5	235.5	248	260.5	273	285.5	298	310.5
L2	200	212.5	225	225	237.5	250	262.5	275	287.5	300
L3	180.5	191	201.5	212	222.5	233	243.5	254	264.5	275
L4	15	16	17	11.5	12.5	13.5	14.5	15.5	16.5	17.5

L plug connector (L)

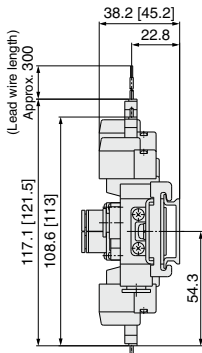

M plug connector (M)

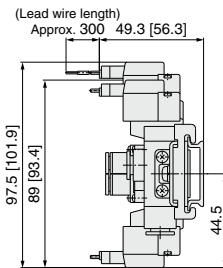

M8 connector (WO)

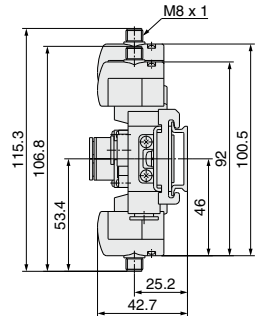

Note) Refer to page 642 for dimensions of connector types.

Dimensions

[] : AC

SS5Y5-60-Stations U

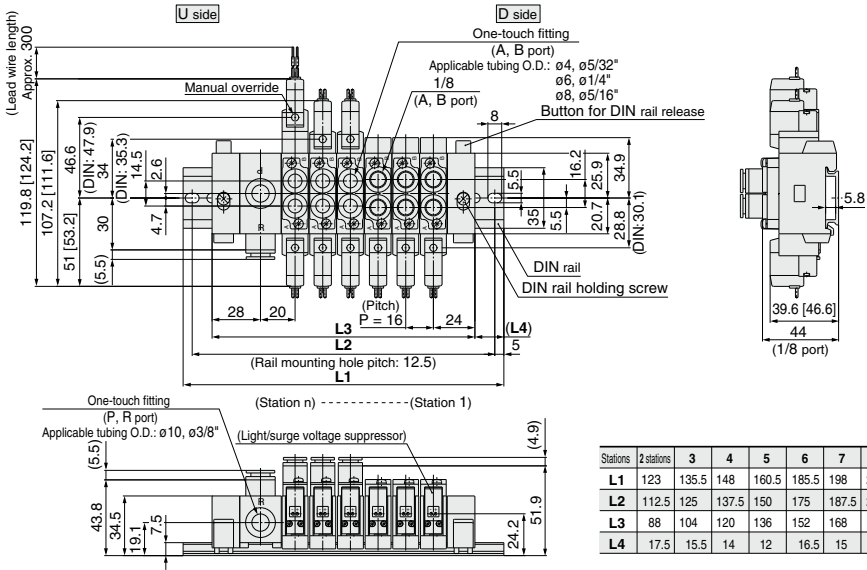

SS5Y5-60-Stations D

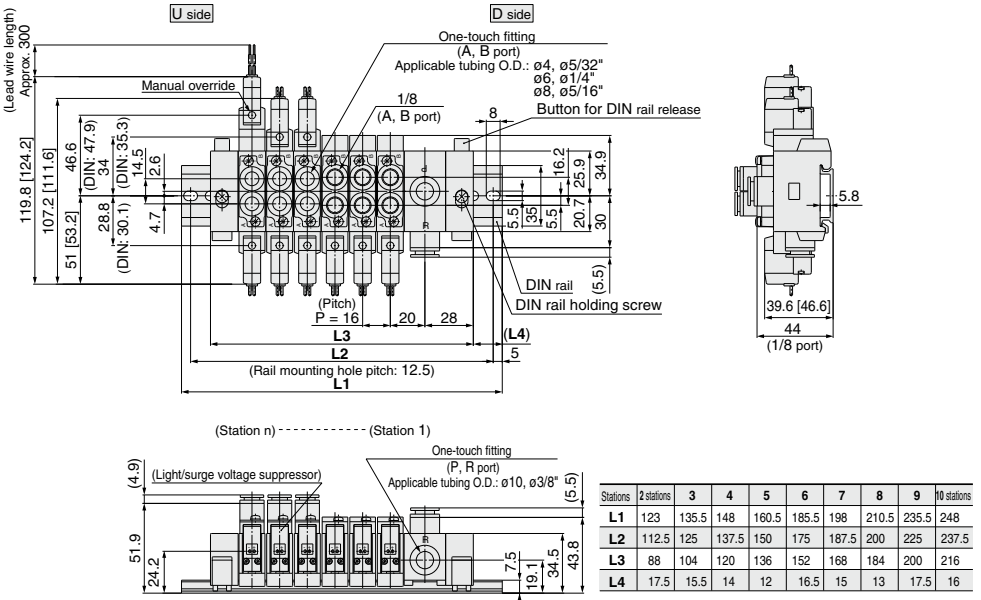

SS5Y5-60-Stations B

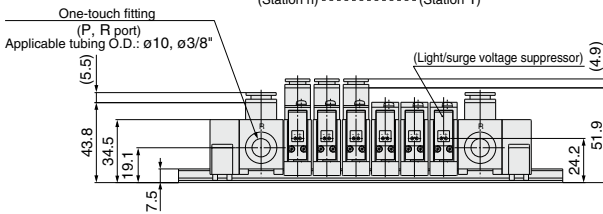
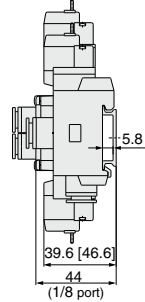
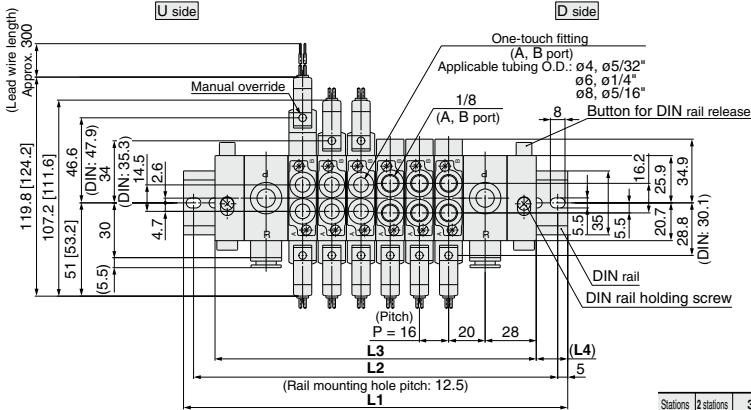

Stations	2 stations	3	4	5	6	7	8 stations
L1	135.5	160.5	173	185.5	210.5	223	235.5
L2	125	150	162.5	175	200	212.5	225
L3	112	128	144	160	176	192	208
L4	11.5	16	14.5	12.5	17.5	15.5	13.5

Stations	9 stations	10	11	12	13	14	15 stations
L1	248	273	285.5	298	323	335.5	348
L2	237.5	262.5	275	287.5	312.5	325	337.5
L3	224	240	256	272	288	304	320
L4	12	16.5	14.5	13	17.5	15.5	14

Stations	16 stations	17	18	19	20 stations
L1	360.5	385.5	398	410.5	435.5
L2	350	375	387.5	400	425
L3	336	352	368	384	400
L4	12	16.5	15	13	17.5

L plug connector (L)

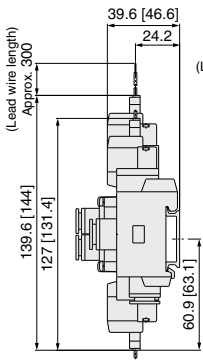

M plug connector (M)

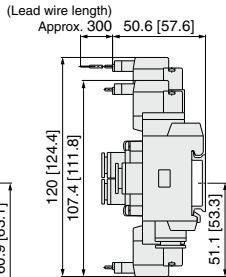

DIN terminal (D, Y)

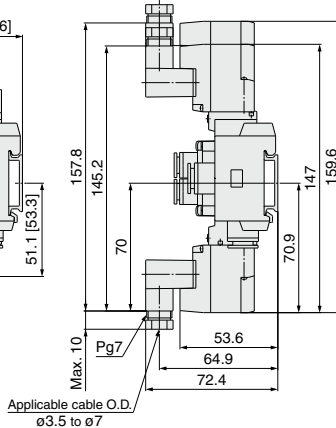

M8 connector (WO)

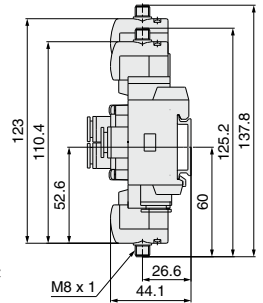

Note) Refer to page 642 for dimensions of connector types.

Dimensions

[] : AC

SS5Y7-60-Stations U

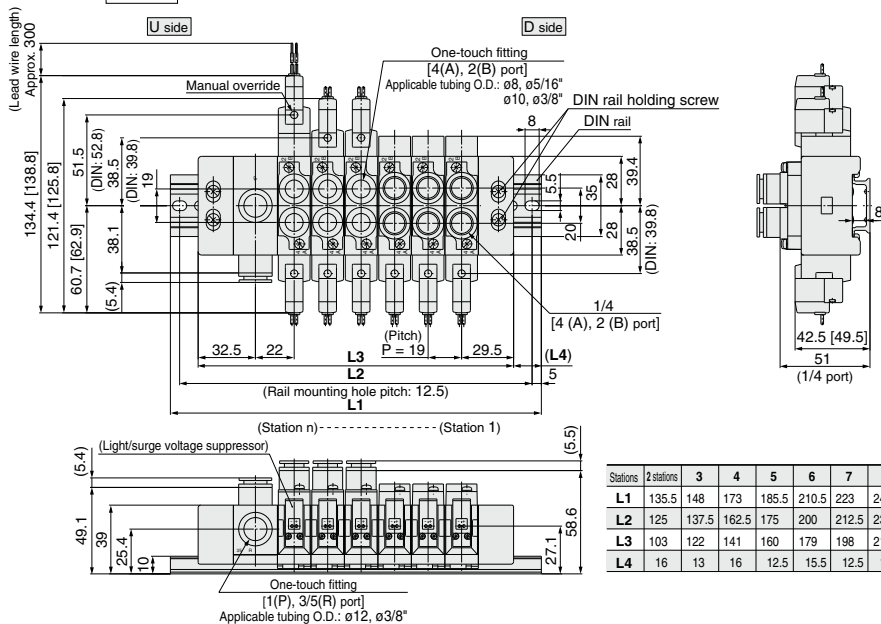

SS5Y7-60-Stations D

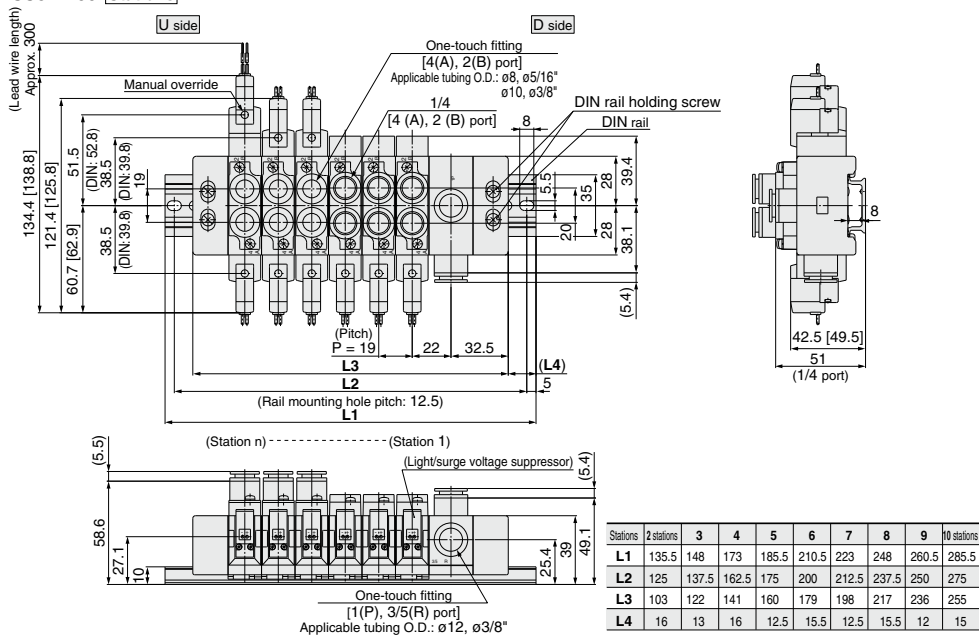

SS5Y7-60-Stations B

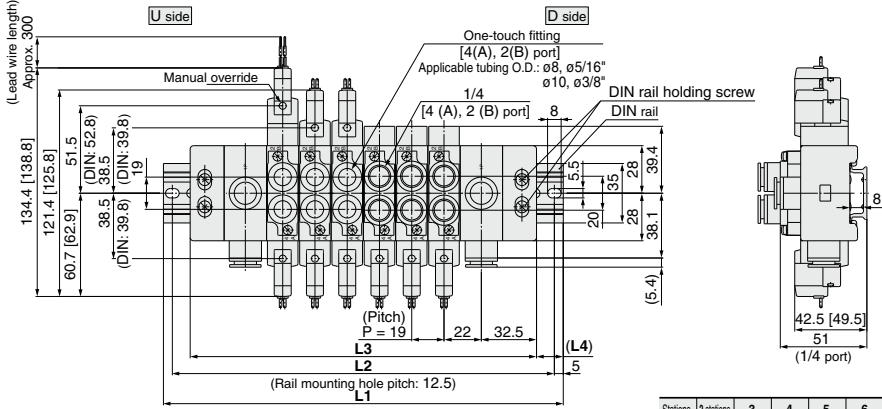

(Station n) ----- (Station 1)

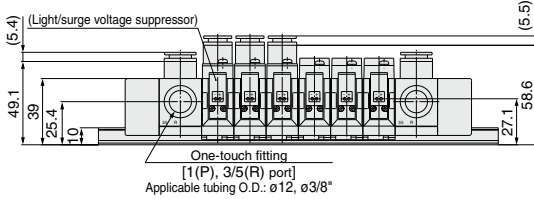

Stations	2 stations	3	4	5	6	7	8 stations
L1	160.5	173	198	210.5	235.5	248	273
L2	150	162.5	187.5	200	225	237.5	262.5
L3	128	147	166	185	204	223	242
L4	16	13	16	12.5	15.5	12.5	15.5

Stations	9 stations	10	11	12	13	14	15 stations
L1	285.5	310.5	323	348	360.5	385.5	410.5
L2	275	300	312.5	337.5	350	375	400
L3	261	280	299	318	337	356	375
L4	12	15	12	15	11.5	14.5	17.5

Stations	16 stations	17	18	19	20 stations
L1	423	448	460.5	485.5	498
L2	412.5	437.5	450	475	487.5
L3	394	413	432	451	470
L4	14.5	17.5	14	17	14

L plug connector (L)

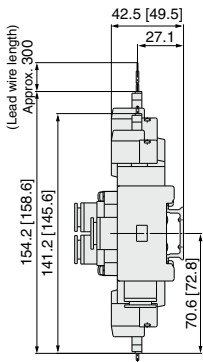

M plug connector (M)

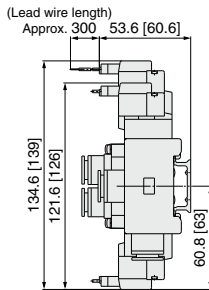

DIN terminal (D, Y)

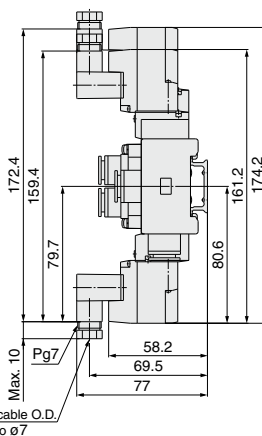

M8 connector (WO)

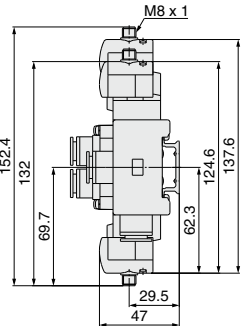

Note) Refer to page 642 for dimensions of connector types.

DIN Rail Manifold Exploded View

SY3000

Type 60

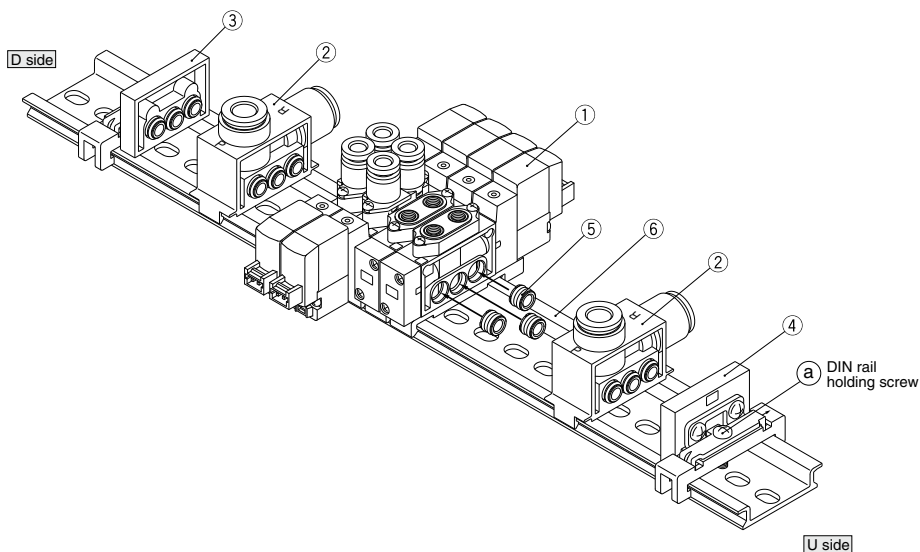

Replacement Parts

No.	Description	Part no.	Note
1	Valve	SY3□60-□□□(-Q)	□ at the end of part number denotes A. B port size: M5, C4, C6, N3, N7. Includes bushing assembly (SY3000-52-5A) 3 pcs.
2	SUP/EXH block assembly	SY3000-55- $\frac{1}{2}$ A(-Q)	P, R port (1: One-touch fitting for ø8, 2: One-touch fitting for ø5/16") Includes bushing assembly (SY3000-52-5A) 3 pcs.
3	End block assembly	SY3000-56-1A(-Q)	For D side (Bushing assembly: Not available for SY3000-52-5A)
4	End block assembly	SY3000-56-1B(-Q)	For U side (Bushing assembly: Not available for SY3000-52-5A)
5	Bushing assembly	SY3000-52-5A	
6	DIN rail	VZ1000-11-1-□	Refer to page 478.

SY5000
Type 60

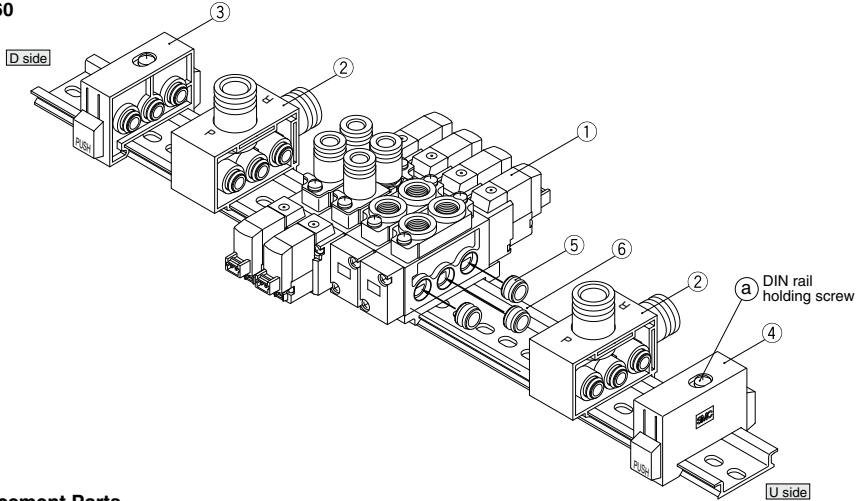

SJ
SY
SY
S0700
S0700

Replacement Parts

No.	Description	Part no.	Note
1	Valve	SY5□60-□□□(-Q)	□ at the end of part number denotes A, B port size: 01, C4, C6, C8, N3, N7, N9. Includes bushing assembly (SY5000-52-3A) 3 pcs.
2	SUP/EXH block assembly	SY5000-55- $\frac{1}{2}$ A(-Q)	P, R port (1: One-touch fitting for $\phi 10$, 2: One-touch fitting for $\phi 3/8$) Includes bushing assembly (SY5000-52-3A) 3 pcs.
3	End block assembly	SY5000-56-1A(-Q)	For D side (Bushing assembly: Not available for SY5000-52-3A)
4	End block assembly	SY5000-56-1B(-Q)	For U side (Bushing assembly: Not available for SY5000-52-3A)
5	Bushing assembly	SY5000-52-3A	
6	DIN rail	VZ1000-11-1-□	Refer to page 478.

How to Add Additional Valves to the DIN Rail Valves can be added at any station on the rail.

- 1 Loosen the manifold base clamping screw ②.
- 2 Separate the valves at the point where more valves are to be added.
- 3 Mount the additional valves on the DIN rail as shown in Fig. 1
- 4 Connect them together while pressing the block assemblies toward each other, and tighten the holding screw ③ to fix them to the DIN rail.

⚠ Caution

Tightening torque
SY3000: 1 N·m
SY5000: 1.4 N·m

(While lightly holding the blocks after fixing an end block on one side, tighten the other end block for better sealing after no gap between valves is confirmed.)

- Bushing assembly must be seated properly to each valve block in order to prevent air leaks from occurring.
- Refer to the fig. 2 when dismantling the valve from the DIN rail.

Fig. 1 Manifold mounting procedure

Fig. 2 Manifold dismantling procedure

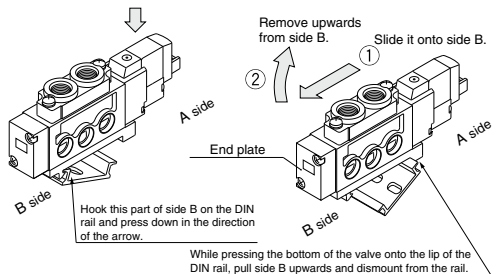

- ⚠ Caution** When clamping screw ③ of the end block is not sufficiently tightened during reassembly, air leakage may result. Before supplying air, check that there are no gaps between valves and that the end block is firmly secured to the DIN rail in order to ensure air supply without leakage.

DIN Rail Manifold Exploded View

SY7000 Type 60

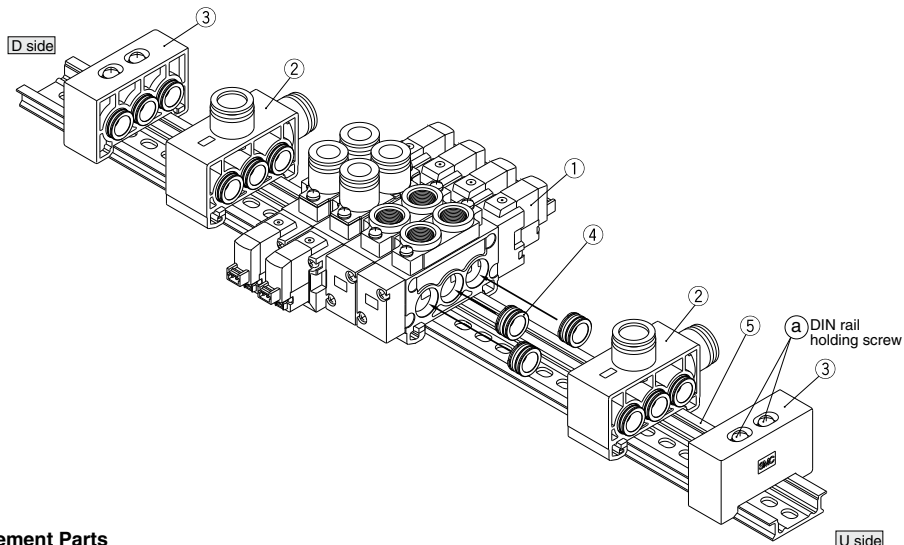

Replacement Parts

No.	Description	Part no.	Note
1	Valve	SY7□60-□□-□(-Q)	□ at the end of part number denotes A, B port size: 02, C8, C10, N9, N11. Includes bushing assembly (SY7000-70-1A) 3 pcs.
2	SUP/EXH block assembly	SY7000-75- ¹ / ₃ A(-Q)	P, R port size (1: ø12 One-touch fitting, 3: 3/8" One-touch fitting) Includes bushing assembly (SY7000-70-1A) 3 pcs.
3	End block assembly	SY7000-56-1A(-Q)	In common for D side and U side (Bushing assembly: Not available for SY7000-70-1A.)
4	Bushing assembly	SY7000-70-1A	
5	DIN rail	VZ1000-11-4-□	Refer to page 478.

How to Add Additional Valves to the DIN Rail

Valves can be added at any station on the rail.

- 1 Loosen the rail holding screw (a) at both of 2 locations which holds the manifold base either in the U side or D side.
[When removing the end block assembly from the DIN rail, loosen the holding screws for DIN rail at first, then slide it to the edge of the rail.]
- 2 Separate the valves at the point where more valves are to be added.
- 3 Mount the additional valves on the DIN rail as shown in Fig. 1.
- 4 Connect them together while pressing the block assemblies toward each other, and tighten the 2 holding screws (a) for DIN rail alternately (2 to 3 times) with the prescribed torque (1.4 N·m) to fix them to the DIN rail.

⚠ Caution

Tightening torque

SY7000: 1.4 N·m

(While lightly holding the blocks after fixing an end block on one side, tighten the other end block for better sealing after no gap between valves is confirmed.)

- Bushing assembly must be seated properly to each valve block in order to prevent air leaks from occurring.
- Refer to the fig. 2 when dismantling the valve from the DIN rail.

Fig. 1 Manifold mounting procedure

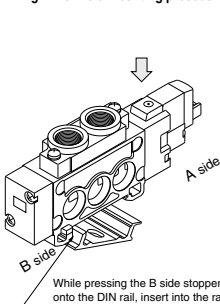
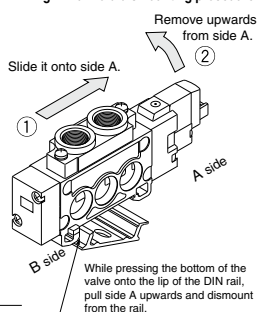

Fig. 2 Manifold dismantling procedure



⚠ Caution

When clamping screw (a) of the end block is not sufficiently tightened during reassembly, air leakage may result. Before supplying air, check that there are no gaps between valves and that the end block is firmly secured to the DIN rail in order to ensure air supply without leakage.

SJ
SY
SY
S0700
S0700



[Option]

Note) AC-type models that are CE-compliant have DIN terminals only.

Type **41**Type **42**

5 Port Solenoid Valve Base Mounted Manifold Bar Stock Type/Individual Wiring **SY3000/5000/7000 Series**

How to Order Manifold

Type 41/Compact type

SS5Y **5** - **41** - **05** - **C8** □ - □

Manifold series

3	SY3000
5	SY5000

Stations

02	2 stations
:	:
20	20 stations

* This also includes the number of blanking plate assemblies.

Thread type

Nll	Rc
F	G
N	NPT
T	NPTF

* Except for M5

CE-compliant

Nll	—
Q	CE-compliant

Note) AC-type models that are CE-compliant have DIN terminals only.

A, B port size

Thread piping

Symbol	Port size	Applicable series
M5	M5 x 0.8	SY3000
01	1/8	SY5000

One-touch fitting (Metric size)

Symbol	Port size	Applicable series
C4	One-touch fitting for ø4	SY3000
C6	One-touch fitting for ø6	SY5000
C6	One-touch fitting for ø6	SY5000
C8	One-touch fitting for ø8	SY5000

One-touch fitting (Inch size)

Symbol	Port size	Applicable series
N3	One-touch fitting for ø $\frac{3}{32}$ "	SY3000
N7	One-touch fitting for ø $\frac{1}{4}$ "	SY3000
N7	One-touch fitting for ø $\frac{1}{4}$ "	SY5000
N9	One-touch fitting for ø $\frac{5}{16}$ "	SY5000

Type 42/External pilot capable

SS5Y **5** - **42** - **05** - **C8** □ - □

Manifold series

3	SY3000
5	SY5000
7	SY7000

Stations

02	2 stations
:	:
20	20 stations

* This also includes the number of blanking plate assemblies.

Thread type

Nll	Rc
F	G
N	NPT
T	NPTF

CE-compliant

Nll	—
Q	CE-compliant

Note) AC-type models that are CE-compliant have DIN terminals only.

A, B port size

Thread piping

Symbol	Port size	Applicable series
01	1/8	SY3000
02	1/4	SY5000
02	1/4	SY7000

One-touch fitting (Metric size)

Symbol	Port size	Applicable series
C4	One-touch fitting for ø4	SY3000
C6	One-touch fitting for ø6	SY5000
C6	One-touch fitting for ø6	SY5000
C8	One-touch fitting for ø8	SY7000
C10	One-touch fitting for ø10	SY7000

One-touch fitting (Inch size)

Symbol	Port size	Applicable series
N3	One-touch fitting for ø $\frac{3}{32}$ "	SY3000
N7	One-touch fitting for ø $\frac{1}{4}$ "	SY3000
N7	One-touch fitting for ø $\frac{1}{4}$ "	SY5000
N9	One-touch fitting for ø $\frac{5}{16}$ "	SY5000
N11	One-touch fitting for ø $\frac{3}{8}$ "	SY7000

How to Order Manifold Assembly (Example)

Example

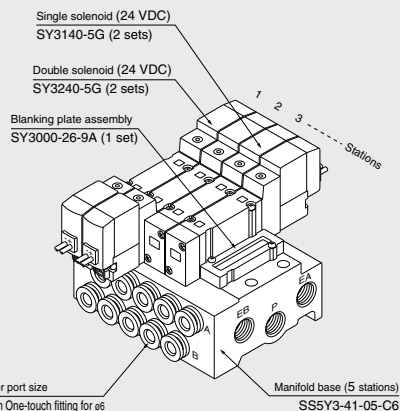

SS5Y3-41-05-C6 ... 1 set (Type 41, 5-station manifold base part no.)

* **SY3240-5G ... 2 sets (Double solenoid part no.)**

* **SY3140-5G ... 2 sets (Single solenoid part no.)**

* **SY3000-26-9A ... 1 set (Blanking plate assembly part no)**

The asterisk denotes the symbol for assembly. Prefix it to the part nos. of the solenoid valve, etc.

Add the valve and option part number under the manifold base part number. In the case of complex arrangement, specify them on the manifold specification sheet.



How to Order Valve

(Note) AC-type models that are CE-compliant have DIN terminals only.

SY **5** **2** **40** - **5** **L** - -

Series

3	SY3000
5	SY5000
7	SY7000

Type of actuation

1	2 position single
2	2 position double
3	3 position closed center
4	3 position exhaust center
5	3 position pressure center

Pilot type

Nil	Internal pilot
R	External pilot

Coil specifications

Nil	Standard
T	With power saving circuit (24 VDC, 12 VDC only)

* Power saving circuit is not available in the case of D, Y, DO, YO or W□ type.

Rated voltage

For DC

5	24 VDC
6	12 VDC
V	6 VDC
S	5 VDC
R	3 VDC

For AC (50/60 Hz)

1	100 VAC
2	200 VAC
3	110 VAC [115 VAC]
4	220 VAC [230 VAC]

* DC specifications of Type D, Y, DO and YO is only available with 12 and 24 VDC.
 * For type W□, DC voltage is only available.
 (Note) AC-type models that are CE-compliant have DIN terminals only.

CE-compliant

Nil	—
Q	CE-compliant

(Note) AC-type models that are CE-compliant have DIN terminals only.

Made to Order

Nil	—
X90	Main valve fluororubber (Refer to page 624.)

Manual override

Nil	Non-locking push type
D	Push-turn locking slotted type
E	Push-turn locking lever type

Light/Surge voltage suppressor

Electrical entry for G, H, L, M, W

Nil	Without light/surge voltage suppressor
S	With surge voltage suppressor
Z	With light/surge voltage suppressor
R	With surge voltage suppressor (Non-polar type)
U	With light/surge voltage suppressor (Non-polar type)

* For AC voltage valves there is no "S" option. It is already built-in to the rectifier circuit.
 * For "R" and "U", DC voltage is only available.
 * Power saving circuit is only available in the "Z" type.

Electrical entry for D, Y

Nil	Without light/surge voltage suppressor
S	With surge voltage suppressor (Non-polar type)
Z	With light/surge voltage suppressor (Non-polar type)

* DOZ and YOZ are not available.
 * For AC voltage valves there is no "S" option. It is already built-in to the rectifier circuit.

(Note) When ordering single unit of the base mounted type solenoid valve, the mounting screws and gaskets for the manifold are included.

Electrical entry

		24, 12, 6, 5, 3 VDC/100, 110, 200, 220 VAC			24, 12 VDC/ 100, 110, 200, 220 VAC	24, 12, 6, 5, 3 VDC
		Grommet	L plug connector	M plug connector	DIN terminal	M8 connector
	G: Lead wire length 300 mm lead		L: With lead wire (Length 300 mm)	M: With lead wire (Length 300 mm)	(SY5000/7000 only) D: With connector	WO: Without connector cable
	H: Lead wire length 600 mm		LN: Without lead wire LO: Without connector	MN: Without lead wire MO: Without connector	DO: Without connector Y: With connector YO: Without connector	WC: With connector cable ^{Note 2)}
					— Note 1)	
Manifold mounting	SY3000	●	●	●	●	●
	SY5000	●	●	●	●	●
	SY7000	●	●	●	●	●
CE-compliant	DC	●	●	●	●	●
	AC	—	—	—	●	—

Note 1) The DIN terminal of the SY3000 series cannot be mounted on a standard manifold. For details, refer to page 639.

Note 2) Enter the cable length symbols in □. Please be sure to fill in the blank referring to page 642.

* LN, MN type: with 2 sockets.

* "Y" type is a DIN terminal conforming to EN-175301-803C (former DIN43650C). For details, refer to page 638.

* For connector cable of M8 connector, refer to page 641.

* M8 connector conforming to IEC60947-5-2 standard is also available. Refer to page 623 for details.

* Refer to page 638 for the lead wire length of L and M plug connectors.

* Refer to page 639 for the connector assembly with cover for L and M plug connectors.

SY
SY
S0700
S0700

Manifold Specifications

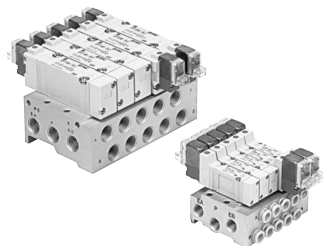

Model	SS5Y3-41(-Q)		SS5Y3-42(-Q)		SS5Y5-41(-Q)		SS5Y5-42(-Q)		SS5Y7-42(-Q)		
Applicable valve	SY3□40				SY5□40						
Manifold type	Single base/B mount										
P(SUP)/R(EXH)	Common SUP, Common EXH										
Valve stations	2 to 20 stations ^{Note 1)}										
A, B port	Base										
Porting specifications	Side										
	P, EA, EB port	1/8				1/4				1/4	
Port size	A, B port	1/8		1/8		1/8		1/4		1/4	
		C4 (One-touch fitting for ø4) C6 (One-touch fitting for ø6)	C4 (One-touch fitting for ø4) C6 (One-touch fitting for ø6)	C6 (One-touch fitting for ø6) C8 (One-touch fitting for ø8)	C6 (One-touch fitting for ø6) C8 (One-touch fitting for ø8)	C8 (One-touch fitting for ø8) C10 (One-touch fitting for ø10)	C8 (One-touch fitting for ø8) C10 (One-touch fitting for ø10)	C10 (One-touch fitting for ø10)	C10 (One-touch fitting for ø10)	C10 (One-touch fitting for ø10)	C10 (One-touch fitting for ø10)
Manifold base weight W (g) n: Stations	W = 30n + 50		W = 37n + 63		W = 61n + 101		W = 79n + 127		W = 100n + 151		

Note 1) For more than 10 stations (more than 5 stations in case of SS5Y7), supply pressure to P port on both sides and exhaust from EA/EB port on both sides.

Note 2) Refer to "Manifold Option" on page 530.

Flow Rate Characteristics

Model	Port size		Flow rate characteristics					
	1, 5, 3 (P, EA, EB)	4, 2 (A, B)	1 → 4/2 (P → A/B)			4/2 → 5/3 (A/B → EA/EB)		
			C (dm ³ /s(bar))	b	Cv	C (dm ³ /s(bar))	b	Cv
SS5Y3-41(-Q)	1/8	C6	0.75	0.19	0.18	0.81	0.23	0.20
SS5Y3-42(-Q)	1/8	C6	0.75	0.20	0.18	0.82	0.20	0.20
SS5Y5-41(-Q)	1/4	C8	1.8	0.23	0.44	1.9	0.16	0.45
SS5Y5-42(-Q)	1/4	C8	1.9	0.20	0.46	1.9	0.12	0.43
SS5Y7-42(-Q)	1/4	C10	3.0	0.25	0.75	3.0	0.12	0.66

Note) The value is for manifold base with 5 stations and individually operated 2 position type.

SY3000: SS5Y3-41-Stations-M5, C4,N3, C6,N7

[]: AC

Grommet (G)

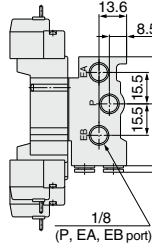
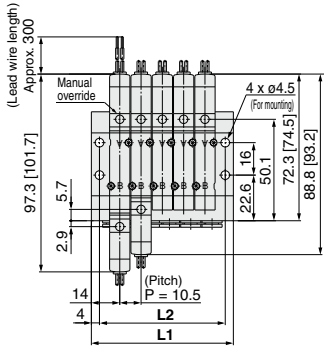

With interface regulator (with gauge)

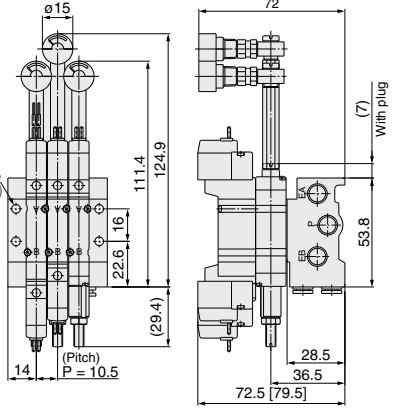

- SJ**
- SY**
- SY**
- S0700**
- S0700**

(Station 1) - - - - (Station n)

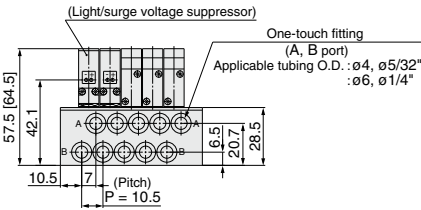

For M5

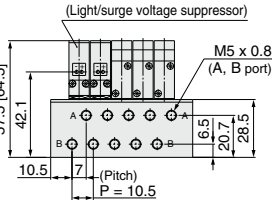

L plug connector (L)

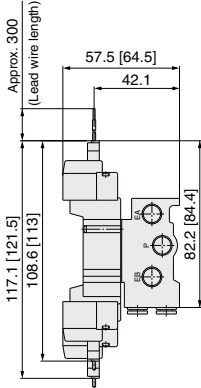

M plug connector (M)

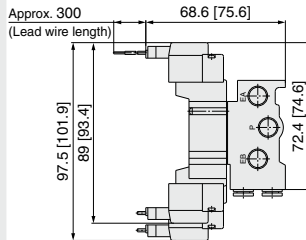

M8 connector (WO)

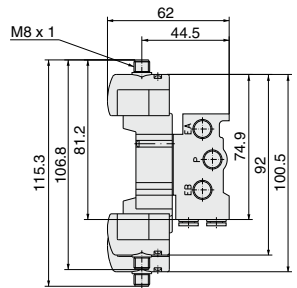

Note) Refer to page 642 for dimensions of connector types.

Stations n	2 stations	3	4	5	6	7	8	9	10	11	12	13	14	15	16	17	18	19	20 stations
L1	38.5	49	59.5	70	80.5	91	101.5	112	122.5	133	143.5	154	164.5	175	185.5	196	206.5	217	227.5
L2	30.5	41	51.5	62	72.5	83	93.5	104	114.5	125	135.5	146	156.5	167	177.5	188	198.5	209	219.5

SY5000: SS5Y5-41- Stations -01, C6, N7, C8, N9

[]: AC

Grommet (G)

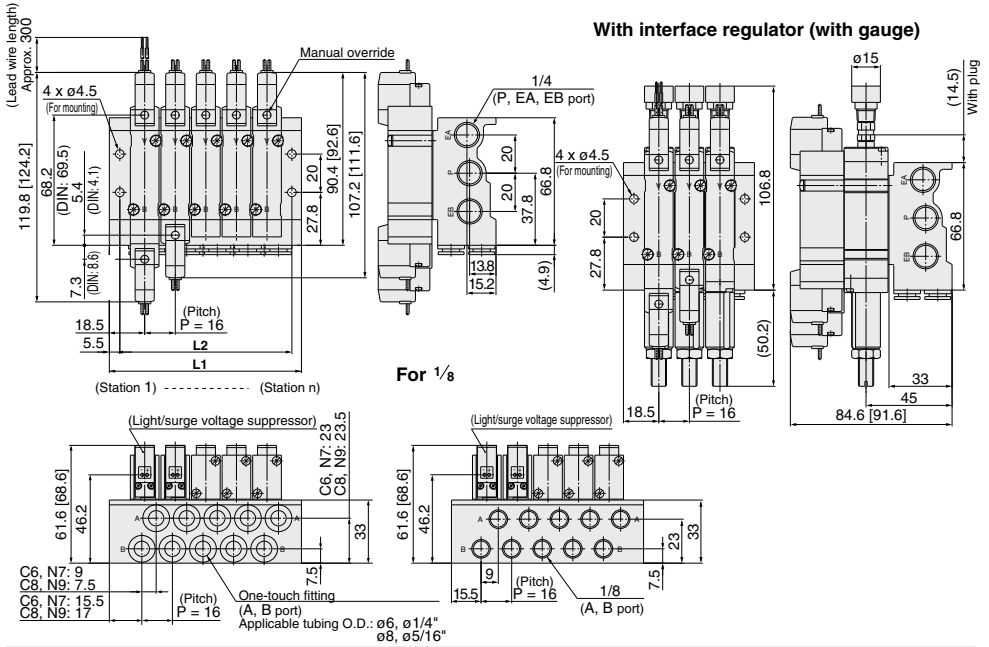

For 1/8

L plug connector (L)

M plug connector (M)

DIN terminal (D, Y)

M8 connector (WO)

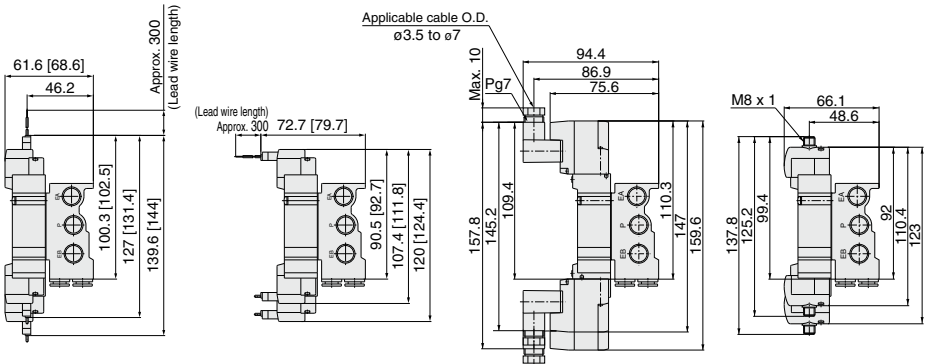

Note) Refer to page 642 for dimensions of connector types.

Stations n	2 stations	3	4	5	6	7	8	9	10	11	12	13	14	15	16	17	18	19	20 stations
L1	52.5	68.5	84.5	100.5	116.5	132.5	148.5	164.5	180.5	196.5	212.5	228.5	244.5	260.5	276.5	292.5	308.5	324.5	340.5
L2	42	58	74	90	106	122	138	154	170	186	202	218	234	250	266	282	298	314	330

SY3000: SS5Y3-42- Stations -01

[] : AC

Grommet (G)

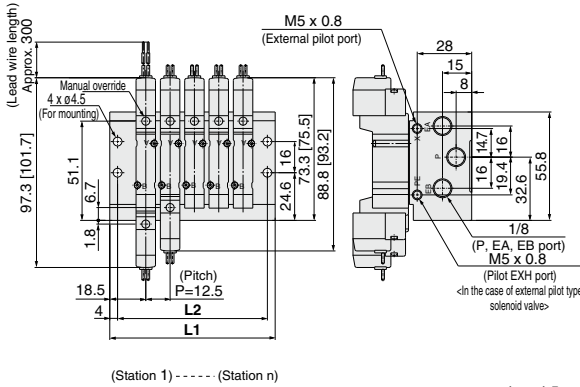

With interface regulator (with gauge)

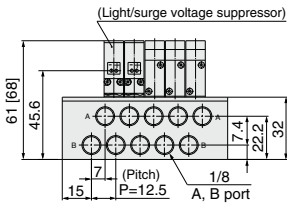
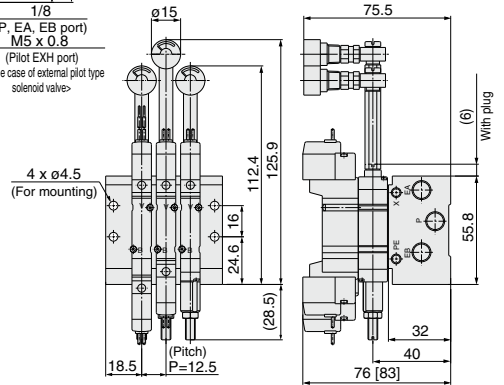

L plug connector (L)

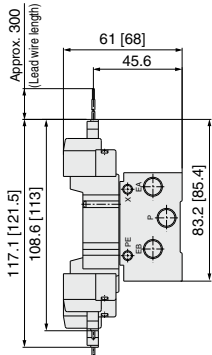

M plug connector (M)

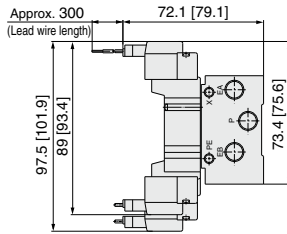

M8 connector (WO)

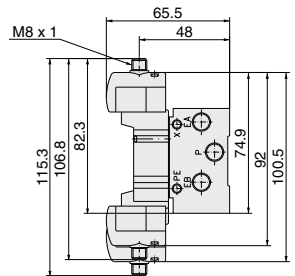

Note) Refer to page 642 for dimensions of connector types.

Stations n	2 stations	3	4	5	6	7	8	9	10	11	12	13	14	15	16	17	18	19	20 stations
L1	47.5	60	72.5	85	97.5	110	122.5	135	147.5	160	172.5	185	197.5	210	222.5	235	247.5	260	272.5
L2	39.5	52	64.5	77	89.5	102	114.5	127	139.5	152	164.5	177	189.5	202	214.5	227	239.5	252	264.5

SY5000: SS5Y5-42- Stations C6, N7
C8, N9

[] : AC

Grommet (G)

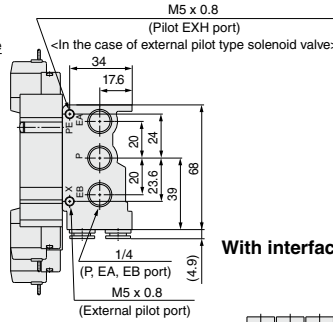
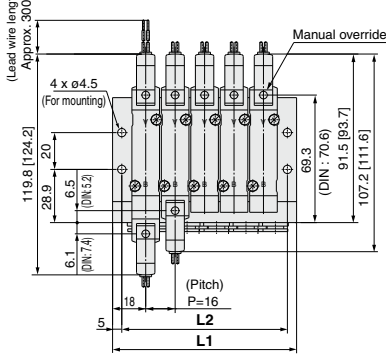

With interface regulator (with gauge)

(Station 1) ----- (Station n)

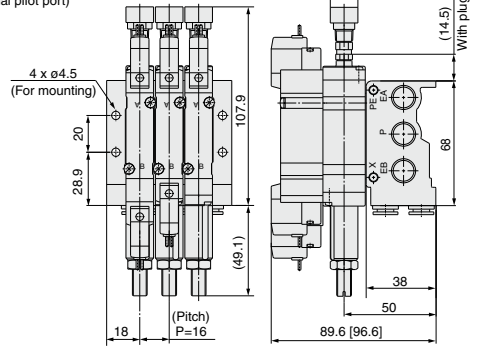
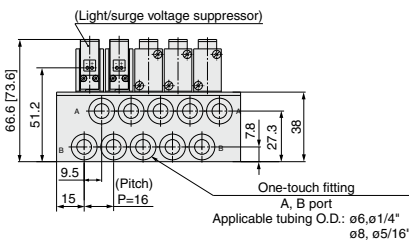

L plug connector (L)

M plug connector (M)

DIN terminal (D, Y)

M8 connector (WO)

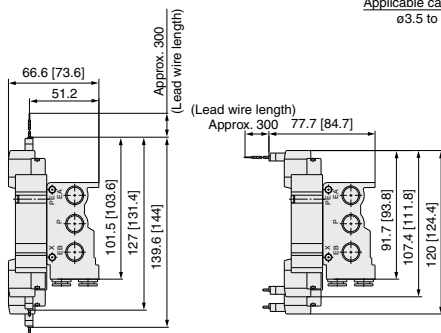

Applicable cable O.D.
 $\phi 3.5$ to $\phi 7$

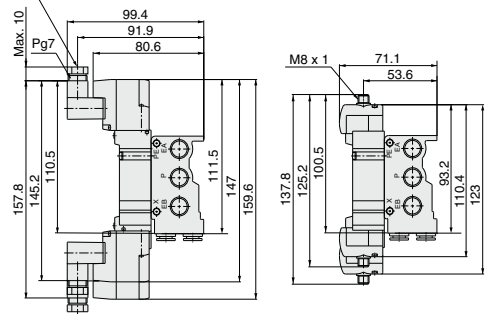

Note) Refer to page 642 for dimensions of connector types.

Stations n	2 stations	3	4	5	6	7	8	9	10	11	12	13	14	15	16	17	18	19	20 stations
L1	52	68	84	100	116	132	148	164	180	196	212	228	244	260	276	292	308	324	340
L2	42	58	74	90	106	122	138	154	170	186	202	218	234	250	266	282	298	314	330

SY5000: SS5Y5-42- Stations -02

[] : AC

Grommet (G)

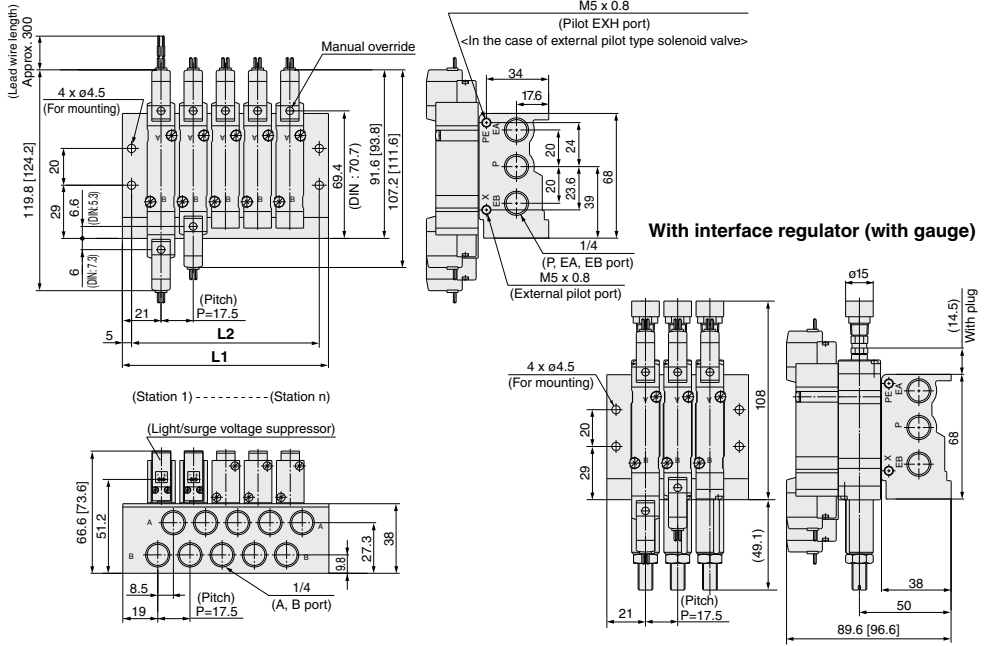

L plug connector (L)

M plug connector (M)

DIN terminal (D, Y)

M8 connector (WO)

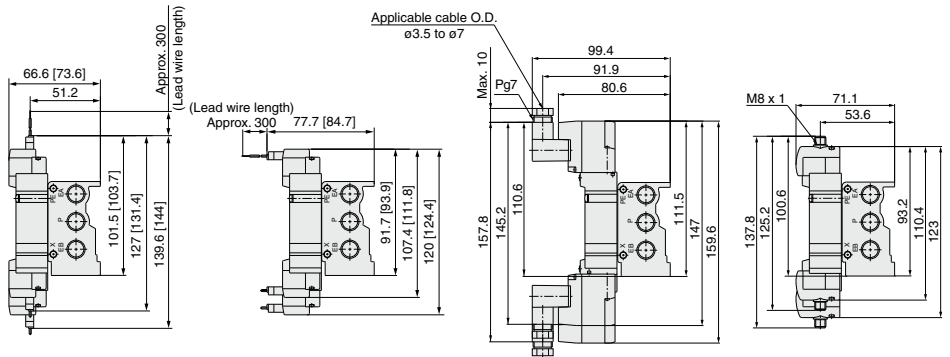

Note) Refer to page 642 for dimensions of connector types.

Stations n	2 stations	3	4	5	6	7	8	9	10	11	12	13	14	15	16	17	18	19	20 stations
L1	59.5	77	94.5	112	129.5	147	164.5	182	199.5	217	234.5	252	269.5	287	304.5	322	339.5	357	374.5
L2	49.5	67	84.5	102	119.5	137	154.5	172	189.5	207	224.5	242	259.5	277	294.5	312	329.5	347	364.5

SY7000: SS5Y7-42- Stations -02, C10, N11

[] : AC

Grommet (G)

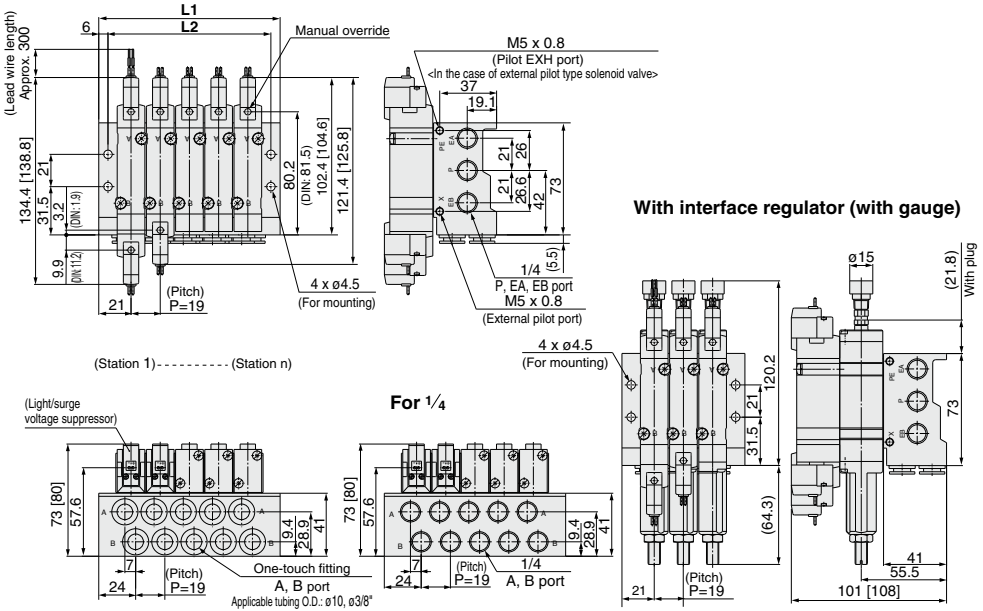

SY
SY
S0700
S0700

L plug connector (L)

M plug connector (M)

DIN terminal (D, Y)

M8 connector (WO)

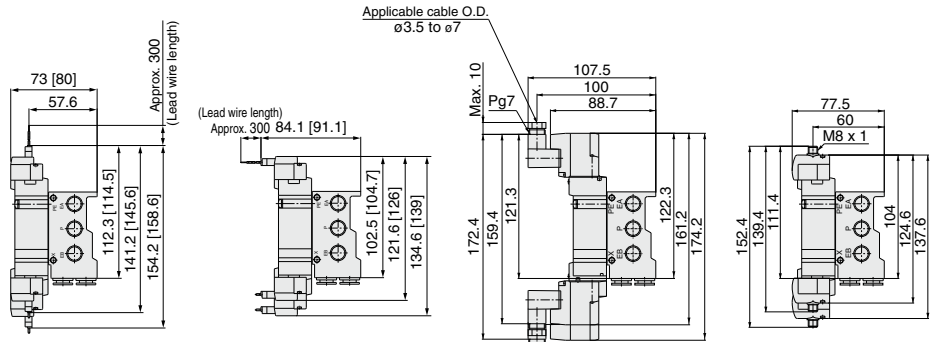

Note) Refer to page 642 for dimensions of connector types.

Stations n	2 stations	3	4	5	6	7	8	9	10	11	12	13	14	15	16	17	18	19	20 stations
L1	61	80	99	118	137	156	175	194	213	232	251	270	289	308	327	346	365	384	403
L2	49	68	87	106	125	144	163	182	201	220	239	258	277	296	315	334	353	372	391

Type **43**

5 Port Solenoid Valve Base Mounted Manifold Stacking Type/Individual Wiring **SY9000 Series**



[Option]
Note) AC-type models that are CE-compliant have DIN terminals only.

How to Order Manifold

SS5Y9 - 43 - 05 U [] - C8 [] - [] - []

• **Manifold series**

9	SY9000
---	--------

• **Valve stations**

Symbol	Stations
02	2 stations
:	:
20	20 stations

* This also includes the number of blanking plate assemblies.

• **P, R port outlets**

Symbol	Port outlet	Applicable stations
U	U side	2 to 10 stations
D	D side	2 to 10 stations
B	Both sides	2 to 20 stations

• **SUP/EXH block assembly specifications**

Symbol	Specifications
NI	Standard/Internal pilot specification
R	External pilot specification
S	Internal pilot/Built-in silencer
RS	External pilot/Built-in silencer

• **Thread type**

NI	Rc
F	G
N	NPT
T	NPTF

* When One-touch fittings are selected for "A, B port size", the symbol is nil.

• **Option**

Symbol	Mounting
NI	Direct mounting
D	DIN rail mounting (with DIN rail)
DO	DIN rail mounting (without DIN rail)
D*	When a longer DIN rail is desired than the specified stations, specify the station number to be required into * mark.

• **A, B port size
Thread piping**

Symbol	Port size
02	1/4
03	3/8

• **One-touch fitting (Metric size)**

Symbol	Port size
C8	One-touch fitting for ø8
C10	One-touch fitting for ø10
C12	One-touch fitting for ø12
M	Mixed

• **One-touch fitting (Inch size)**

Symbol	Port size
N9	One-touch fitting for ø3/16"
N11	One-touch fitting for ø3/8"
M	Mixed

* In the case of mixed specifications (M), indicate separately on the manifold specification sheet.

• **CE-compliant**

NI	—
Q	CE-compliant

Note) AC-type models that are CE-compliant have DIN terminals only.

How to Order Manifold Assembly (Example)

Example

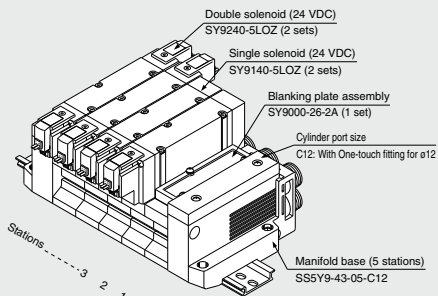

SS5Y9-43-05B-C12 ... 1 set (Type 43, 5-station manifold base part no.)
 * **SY9000-26-2A ... 1 set (Blanking plate assembly part no.)**
 * **SY9140-5LOZ ... 2 sets (Single solenoid part no.)**
 * **SY9220-5LOZ ... 2 sets (Double solenoid part no.)**

The asterisk denotes the symbol for assembly. Prefix it to the part nos. of the solenoid valve, etc.

Add the valve and option part number under the manifold base part number. In the case of complex arrangement, specify them on the manifold specification sheet.



How to Order Valve

(Note) AC-type models that are CE-compliant have DIN terminals only.

(Option)



Series

9	SY9000
---	--------

Type of actuation

1	2 position single
2	2 position double
3	3 position closed center
4	3 position exhaust center
5	3 position pressure center

Pilot type

Nil	Internal pilot
R	External pilot

Coil specifications

Nil	Standard
T	With power saving circuit (24, 12 VDC only)

* Power saving circuit is not available in the case of D, Y, DO, YO or W□ type.

Rated voltage

For DC	
5	24 VDC
6	12 VDC
V	6 VDC
S	5 VDC
R	3 VDC

For AC (%/60 Hz)	
1	100 VAC
2	200 VAC
3	110 VAC [115 VAC]
4	220 VAC [230 VAC]

* DC specifications of Type D, Y, DO and YO is only available with 12 and 24 VDC.
* For type W□, DC voltage is only available.

(Note) AC-type models that are CE-compliant have DIN terminals only.

CE-compliant

Nil	—
Q	CE-compliant

(Note) AC-type models that are CE-compliant have DIN terminals only.

Made to Order

Nil	—
X90	Main valve fluororubber (Refer to page 624.)

Manual override

Nil	Non-locking push type
D	Push-turn locking slotted type
E	Push-turn locking lever type

Light/Surge voltage suppressor

Electrical entry for G, H, L, M, W	
Nil	Without light/surge voltage suppressor
S	With surge voltage suppressor
Z	With indicator light and surge voltage suppressor
R	With surge voltage suppressor (Non-polar type)
U	With light/surge voltage suppressor (Non-polar type)

* For AC voltage valves there is no "S" option. It is already built-in to the rectifier circuit.
* For "R" and "U", DC voltage is only available.
* Power saving circuit is only available in the "Z" type.

Electrical entry for D, Y	
Nil	Without light/surge voltage suppressor
S	With surge voltage suppressor (Non-polar type)
Z	With light/surge voltage suppressor (Non-polar type)

* DOZ and YOZ are not available.
* For AC voltage valves there is no "S" option. It is already built-in to the rectifier circuit.

Electrical entry

		24, 12, 6, 5, 3 VDC/ 100, 110, 200, 220 VAC			24, 12 VDC/ 100, 110, 200, 220 VAC		24, 12, 6, 5, 3 VDC		
		Grommet	L plug connector	M plug connector	DIN terminal	M8 connector			
G:	Lead wire length 300 mm	L:	With lead wire (Length 300 mm)	M:	With lead wire (Length 300 mm)	D:	With connector	WO:	Without connector cable
H:	Lead wire length 600 mm	LN:	Without lead wire	MN:	Without lead wire	DO:	Without connector	Y:	With connector
		LO:	Without connector	MO:	Without connector	YO:	Without connector	W□:	With connector cable (Note)
CE-compliant	DC	●	●	●	●	●	●	●	●
	AC	—	—	—	—	●	—	—	—

(Note) When ordering single unit of the base mounted type solenoid valve, the mounting screws and gaskets for the manifold are included.

- * LN, MN type: with 2 sockets.
 - * DIN terminal type "Y" which conforms to EN-175301-803C (former DIN43650C) is also available. For details, refer to page 638.
 - * For connector cable of M8 connector, refer to page 641.
 - * M8 connector conforming to IEC60947-5-2 standard is also available. Refer to page 623 for details.
 - * Refer to page 638 for the lead wire length of L and M plug connectors.
 - * Refer to page 639 for the connector assembly with cover for L and M plug connectors.
- (Note) Enter the cable length symbols in □. Please be sure to fill in the blank referring to page 642.

SY
SY
S0700
S0700

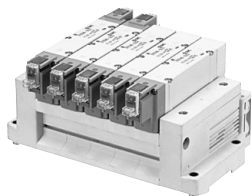

Manifold Specifications

Model		SS5Y9-43(-Q)
Applicable valve		SY9□40
Manifold type		Stacking type
P(SUP)/R(EXH)		Common SUP, Common EXH
Valve stations		2 to 20 stations ⁽¹⁾
A, B port	Location	Base
Porting specifications	Direction	Side
P, EA, EB port		C12 (One-touch fitting for ø12)
Port size	A, B port	1/4
		3/8
		C8 (One-touch fitting for ø8)
		C10 (One-touch fitting for ø10)
C12 (One-touch fitting for ø12)		
Manifold base weight		W = 107n + 330
W (g), n: Stations		

Note 1) For more than 10 stations, supply pressure to P port on both sides and exhaust from EA/EB port on both sides.

Note 2) Refer to "Manifold Option" on page 530.

Flow Rate Characteristics

Model	Port size		Flow rate characteristics					
	1, 5, 3 (P, EA, EB)	4, 2 (A, B)	1→4/2 (P→A/B)			4/2→5/3 (A/B→EA/EB)		
			C (dm ³ /sbar)	b	Cv	C (dm ³ /sbar)	b	Cv
SS5Y9-43(-Q)	C12	C12	6.4	0.29	1.6	7.3	0.29	1.8

Note) The value is for manifold base with 5 stations and individually operated 2 position type.

SY9000: SS5Y9-43- Stations D - ^{02, C8, N9} _{03, C10, N11} **(-D)**

[] : AC

Grommet (G)

* When P, R port outlets are indicated on the D side, the P, R ports on the opposite side are plugged.

With External Pilot Specifications

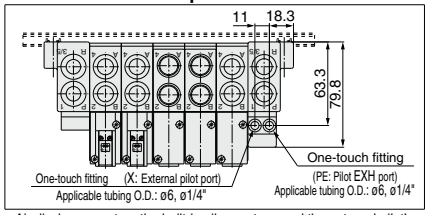
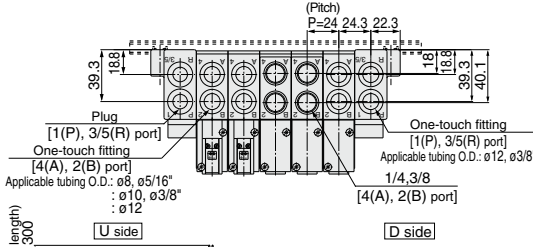

* Air discharge port on the built-in silencer type and the external pilot's extracting position are in the D side.

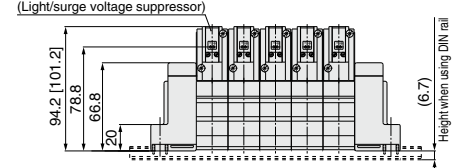
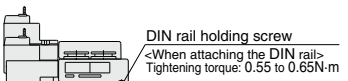
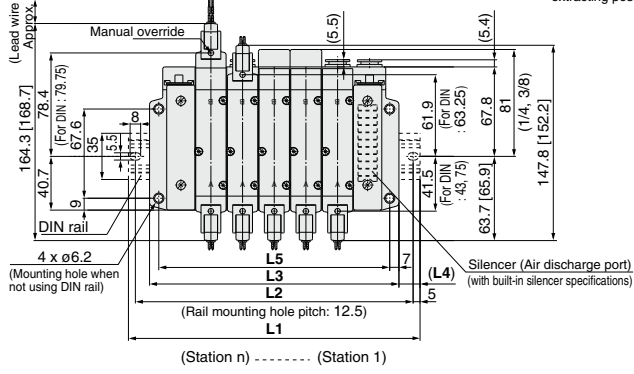

Stations n	2 stations	3	4	5	6	7	8	9	10 stations
L1	148	173	198	223	248	260.5	285.5	310.5	335.5
L2	137.5	162.5	187.5	212.5	237.5	250	275	300	325
L3	117	141	165	189	213	237	261	285	309
L4	15.5	16	16.5	17	17.5	12	12.5	13	13.5
L5	103	127	151	175	199	223	247	271	295

L plug connector (L)

M plug connector (M)

DIN terminal (D, Y)

M8 connector (WO)

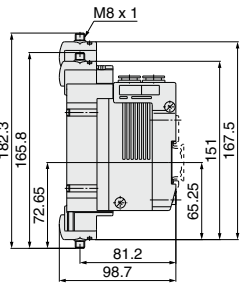
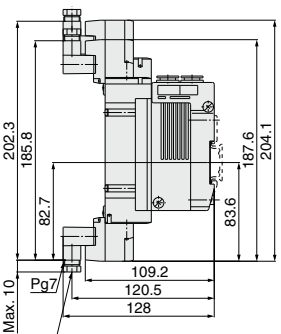
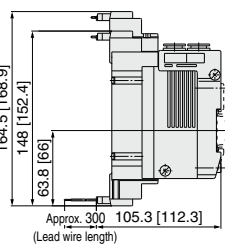
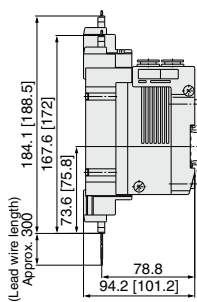

Applicable cable O.D. ø3.5 to ø7

Note) Refer to page 642 for dimensions of connector types.

SY9000: SS5Y9-43- Stations U -02 C9, N9 C10, N11 C12 (-D)

[] : AC

Grommet (G)

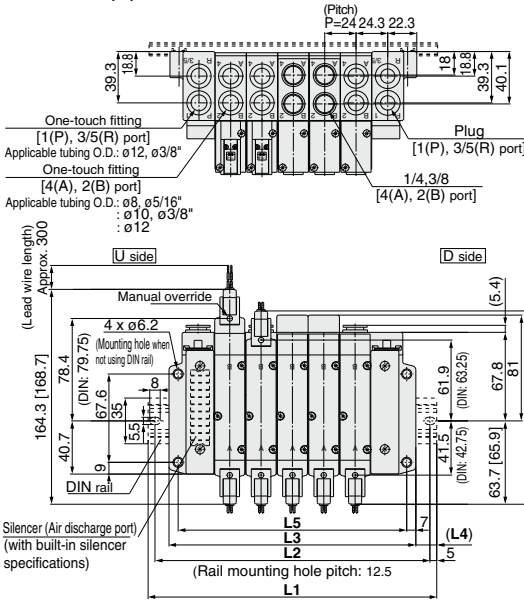

* When P, R port outlets are indicated on the U side, the P, R ports on the opposite side are plugged.

With External Pilot Specifications

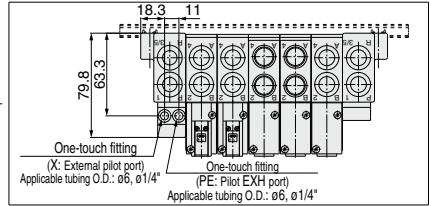

* Air discharge port on the built-in silencer type and the external pilot's extracting position are in the D side.

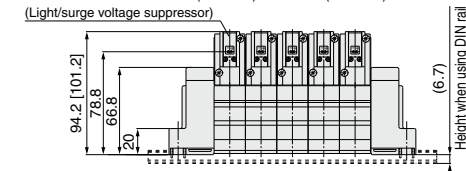
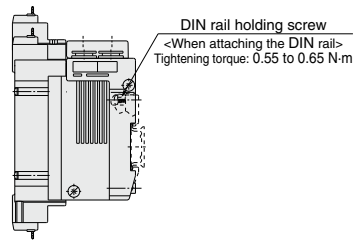

Stations n	2 stations	3	4	5	6	7	8	9	10 stations
L1	148	173	198	223	248	260.5	285.5	310.5	335.5
L2	137.5	162.5	187.5	212.5	237.5	250	275	300	325
L3	117	141	165	189	213	237	261	285	309
L4	15.5	16	16.5	17	17.5	12	12.5	13	13.5
L5	103	127	151	175	199	223	247	271	295

L plug connector (L)

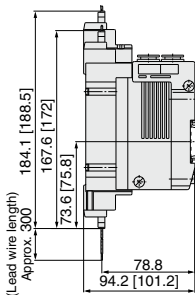

M plug connector (M)

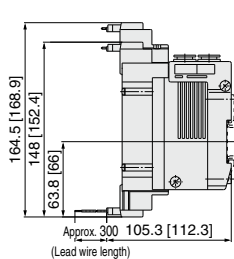

DIN terminal (D, Y)

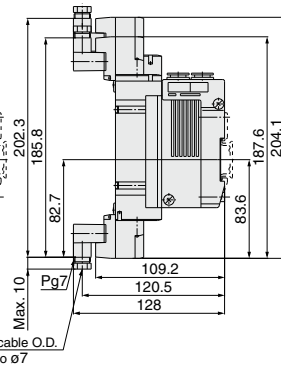

M8 connector (WO)

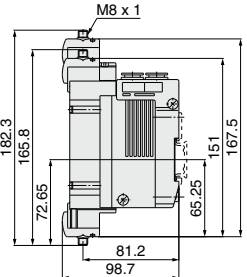

Note) Refer to page 642 for dimensions of connector types.

SY9000: SS5Y9-43- Stations **B** ^{02, C8, N9} _{03, C10, N11} **(-D)**

[] : AC

Grommet (G)

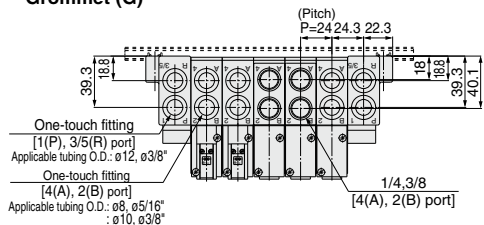

* When P, R port outlets are indicated on the B side, the P, R ports on the both sides are in the open state.

With External Pilot Specifications

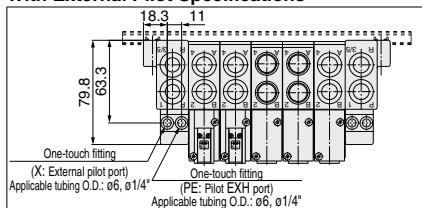

* Air discharge port on the built-in silencer type and the external pilot's extracting position are in the B side (both sides).

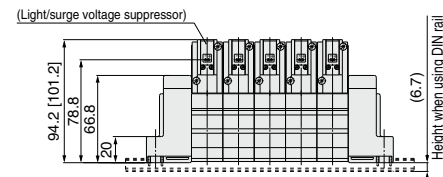
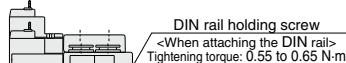
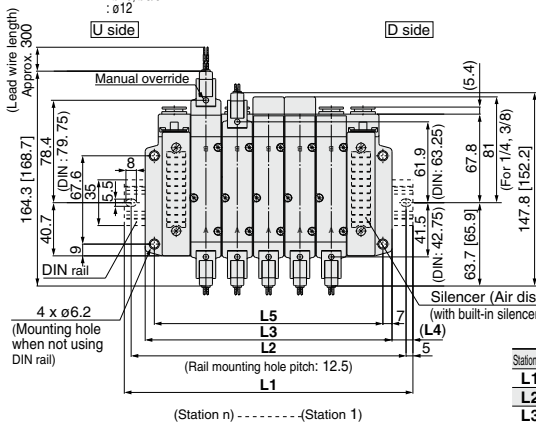

Stations	2 stations	3	4	5	6	7	8	9	10 stations
L1	148	173	198	223	248	260.5	285.5	310.5	335.5
L2	137.5	162.5	187.5	212.5	237.5	250	275	300	325
L3	117	141	165	189	213	237	261	285	309
L4	15.5	16	16.5	17	17.5	12	12.5	13	13.5
L5	103	127	151	175	199	223	247	271	295

Stations	n	11 stations	12	13	14	15	16	17	18	19	20 stations
L1		360.5	385.5	410.5	435.5	460.5	485.5	510.5	535.5	560.5	573
L2		350	375	400	425	450	475	500	525	550	562.5
L3		333	357	381	405	429	453	477	501	525	549
L4		14	14.5	15	15.5	16	16.5	17	17.5	18	12
L5		319	343	367	391	415	439	463	487	511	535

L plug connector (L)

M plug connector (M)

DIN terminal (D, Y)

M8 connector (WO)

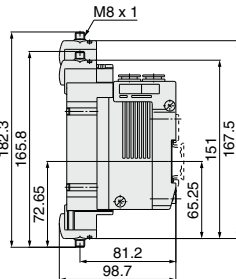
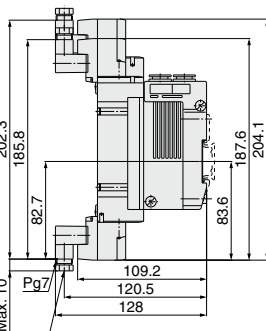
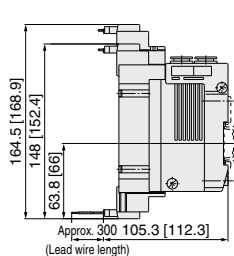
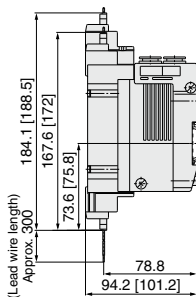

Applicable cable O.D.
ø3.5 to ø7

Note) Refer to page 642 for dimensions of connector types.

Type **41P**
Type **42P**

5 Port Solenoid Valve Base Mounted Manifold Bar Stock Type/Flat Ribbon Cable **SY3000/5000/7000 Series**

Note) CE-compliant:
For DC only. [Option]



How to Order Manifold

Type 41P/Compact type

SS5Y 5 - 41P - 05 - C8 [] [] []

Manifold series ●

3	SY3000
5	SY5000

Stations ●

03	3 stations
:	:
12	12 stations

* SS5Y3 has 4 to 12 stations.
* This also includes the number of blanking plate assemblies.

● A, B port size
Thread piping

Symbol	Port size	Applicable series
M5	M5 x 0.8	SY3000
01	1/8	SY5000

Thread type ●

	Nil	Rc	CE-compliant ●
F	F	G	Nil
N	NPT	Q	CE-compliant
T	NPTF	Q	CE-compliant

Note) CE-compliant:
For DC only.

One-touch fitting (Metric size)

Symbol	Port size	Applicable series
C4	One-touch fitting for ø4	SY3000
C6	One-touch fitting for ø6	SY3000
C6	One-touch fitting for ø6	SY5000
C8	One-touch fitting for ø8	SY5000

One-touch fitting (Inch size)

Symbol	Port size	Applicable series
N3	One-touch fitting for ø ³² / ₃₂	SY3000
N7	One-touch fitting for ø ¹⁴ / ₁₆	SY3000
N7	One-touch fitting for ø ¹⁴ / ₁₆	SY5000
N9	One-touch fitting for ø ⁹ / ₁₆	SY5000

Type 42P/Common external pilot capable

SS5Y 5 - 42P - 05 - C8 [] [] []

Manifold series ●

3	SY3000
5	SY5000
7	SY7000

Stations ●

03	3 stations
:	:
12	12 stations

* SS5Y3 has 4 to 12 stations.
* This also includes the number of blanking plate assemblies.

● A, B port size
Thread piping

Symbol	Port size	Applicable series
01	1/8	SY3000
02	1/4	SY5000
02	1/4	SY7000

Thread type ●

	Nil	Rc	CE-compliant ●
F	F	G	Nil
N	NPT	Q	CE-compliant
T	NPTF	Q	CE-compliant

Note) CE-compliant:
For-DC only.

One-touch fitting (Metric size)

Symbol	Port size	Applicable series
C4	One-touch fitting for ø4	SY3000
C6	One-touch fitting for ø6	SY3000
C6	One-touch fitting for ø6	SY5000
C8	One-touch fitting for ø8	SY5000
C10	One-touch fitting for ø10	SY7000

One-touch fitting (Inch size)

Symbol	Port size	Applicable series
N3	One-touch fitting for ø ³² / ₃₂	SY3000
N7	One-touch fitting for ø ¹⁴ / ₁₆	SY3000
N7	One-touch fitting for ø ¹⁴ / ₁₆	SY5000
N9	One-touch fitting for ø ⁹ / ₁₆	SY5000
N11	One-touch fitting for ø ⁹ / ₁₆	SY7000

How to Order Manifold Assembly (Example)

Example

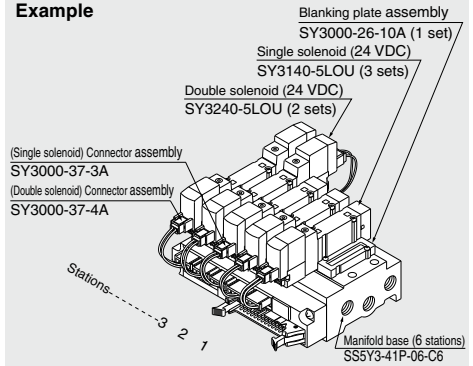

- SS5Y3-41P-06-C6... 1 set (Type 41P, 6-station manifold base part no.)**
*** SX3000-26-10A..... 1 set (Blanking plate assembly part no.)**
*** SY3140-5LOU..... 3 sets (Single solenoid part no.)**
*** SY3240-5LOU..... 2 sets (Double solenoid part no.)**
*** SY3000-37-3A..... 3 sets (Connector assembly part no.)**
*** SY3000-37-4A..... 2 sets (Connector assembly part no.)**

→ The asterisk denotes the symbol for assembly.
Prefix it to the part nos. of the solenoid valve, etc.

Add the valve and option part number under the manifold base part number. In the case of complex arrangement, specify them on the manifold specification sheet.

Note) Please indicate the connector assembly part no. (page 507) that connects the valve and the manifold.



Note) CE-compliant:
For DC only. [Option]

How to Order Valve

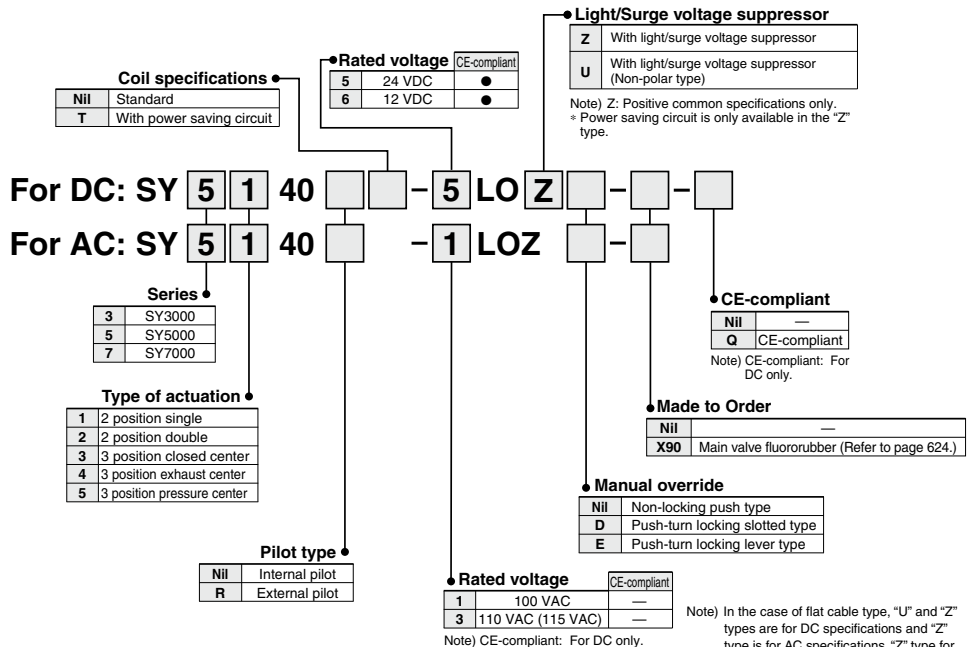

SY
S0700
S0700

Note) When ordering single unit of the base mounted type solenoid valve, the mounting screws and gaskets for the manifold are included.

Note) In the case of flat cable type, "U" and "Z" types are for DC specifications and "Z" type is for AC specifications. "Z" type for DC is positive common specification only. For the other combination, please contact SMC.

Note) Since the electrical entry is "LO", select an appropriate connector assembly part no.

Connector Assembly

For 12, 24 VDC

Specifications	For SY3000	For SY5000/7000
For single solenoid	SY3000-37-3A	SY5000-37-3A
Double solenoid, 3 position type	SY3000-37-4A	SY5000-37-4A
Single with spacer assembly	SY5000-37-3A	SY5000-37-5A
Double, 3 position with spacer assembly	SY3000-37-6A	SY5000-37-6A

Note) Spacer assembly indicates Individual SUP/EXH spacer.

For 100 VAC

Specifications	For SY3000	For SY5000/7000
For single solenoid	SY3000-37-32A	SY5000-37-15A
Double solenoid, 3 position type	SY3000-37-33A	SY5000-37-16A
Single with spacer assembly	SY5000-37-15A	SY5000-37-17A
Double, 3 position with spacer assembly	SY3000-37-34A	SY5000-37-18A

For 100 VAC (115 VAC)

Specifications	For SY3000	For SY5000/7000
For single solenoid	SY3000-37-35A	SY5000-37-19A
Double solenoid, 3 position type	SY3000-37-36A	SY5000-37-20A
Single with spacer assembly	SY5000-37-19A	SY5000-37-21A
Double, 3 position with spacer assembly	SY3000-37-37A	SY5000-37-22A

Flat Ribbon Cable Manifold Specifications

• **Multiple valve wiring is simplified through the use of the flat cable connector.**

• **Clean appearance**

In the case of a flat ribbon cable type, each valve is wired on the print board of manifold base to allow the external wiring to be piped all together with 26 pins MIL connector.

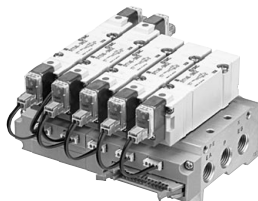

Model	SS5Y3-41P(-Q)	SS5Y3-42P(-Q)	SS5Y5-41P(-Q)	SS5Y5-42P(-Q)	SS5Y7-42P(-Q)
Applicable valve	SY3□40		SY5□40		
Manifold type	Single base/B mount				
P(SUP)/R(EXH)	Common SUP, Common EXH				
Valve stations	4 to 12 stations ⁽¹⁾		3 to 12 stations ^(Note 1)		
A, B port	Location	Base			
	Porting specifications	Side			
Port size	P, EA, EB port	1/8		1/4	
	A, B port	MS x 0.8 C4 (One-touch fitting for ø4) C6 (One-touch fitting for ø6)	1/8 C4 (One-touch fitting for ø4) C6 (One-touch fitting for ø6)	1/8 C6 (One-touch fitting for ø6) C8 (One-touch fitting for ø8)	1/4 C8 (One-touch fitting for ø8) C8 (One-touch fitting for ø8)
Manifold base weight W (g), n: Stations	W = 39n + 83	W = 48n + 99	W = 67n + 118	W = 88n + 151	W = 109n + 174
Applicable flat ribbon cable connector	Flat ribbon cable connector, Socket: 26 pins MIL type with strain relief, Conforming to MIL-C-83503				
Internal wiring	In common between +COM and -COM (Z type: +COM only).				
Rated voltage ^(Note 4)	12, 24 VDC, 100, 110 VAC				

Note 1) For more than 10 stations (more than 5 stations in case of SS5Y7), supply pressure to P port on both sides and exhaust from EA/EB port on both sides.

Note 2) The withstand voltage specification for the wiring unit section is JIS C 0704, Grade 1 or its equivalent.

Note 3) Refer to "Manifold Option" on page 530.

Note 4) CE-compliant: For DC only.

Flow Rate Characteristics

Model	Port size		Flow rate characteristics					
	1, 5, 3 (P, EA, EB)	4, 2 (A, B)	1 → 4/2 (P → A/B)			4/2 → 5/3 (A/B → EA/EB)		
			C (dm ³ /(s·bar))	b	Cv	C (dm ³ /(s·bar))	b	Cv
SS5Y3-41P	1/8	C6	0.75	0.19	0.18	0.81	0.23	0.20
SS5Y3-42P	1/8	C6	0.75	0.20	0.18	0.82	0.20	0.20
SS5Y5-41P	1/4	C8	1.8	0.23	0.44	1.9	0.16	0.45
SS5Y5-42P	1/4	C8	1.9	0.20	0.46	1.9	0.12	0.43
SS5Y7-42P	1/4	C10	3.0	0.25	0.75	3.0	0.12	0.66

Note) The value is for manifold base with 5 stations and individually operated 2 position type.

Internal Wiring of Manifold

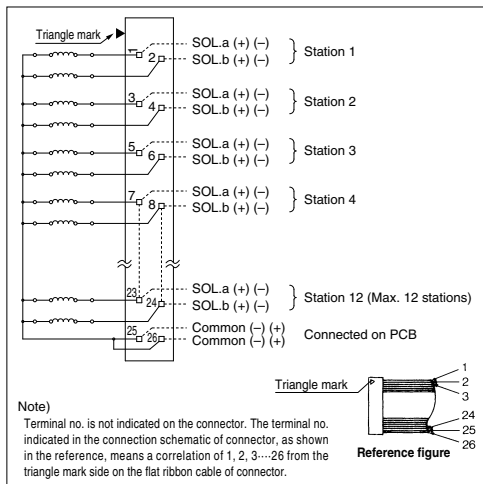

- For more than 10 stations, both poles of the common should be wired.
- For single solenoid, connect to the solenoid A side.
- The maximum number of stations that can be accommodated is 12. For more stations, please contact SMC.

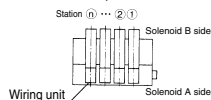

Caution

- For non-polar (U) valves, the electrical DC connections can be used with either positive and negative COM. For type (Z), only use with positive COM as the valve does not operate correctly when used with negative COM.

SY3000: SS5Y3-41P-Stations -M5, C4, N3, C6, N7

[]: AC

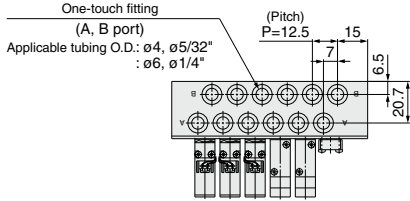

For M5 x 0.8

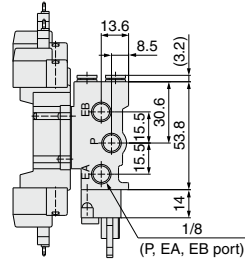
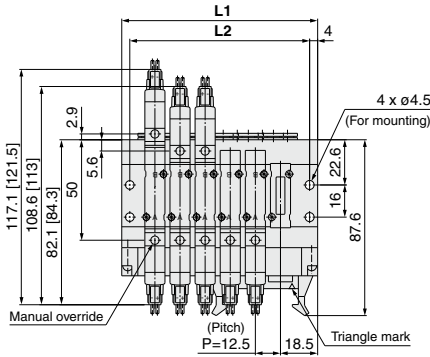
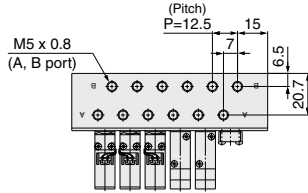

With interface regulator (with gauge)

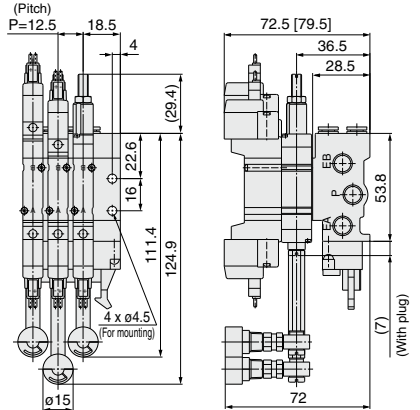
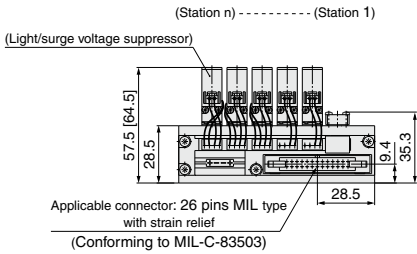

Stations n	4	5	6	7	8	9	10	11	12
L1	72.5	85	97.5	110	122.5	135	147.5	160	172.5
L2	64.5	77	89.5	102	114.5	127	139.5	152	164.5

- SJ**
- SY**
- SY**
- S0700**
- S0700**

SY5000: SS5Y5-41P-Stations -01, C6,N7, C8,N9

[] : AC

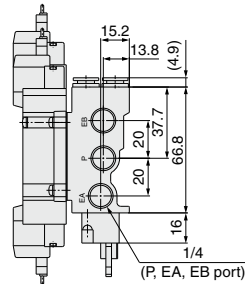
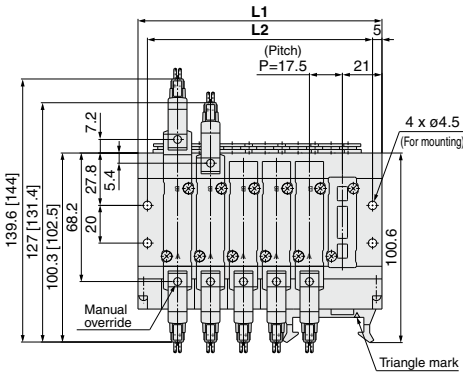
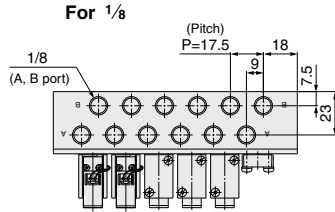
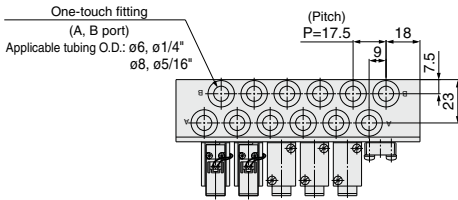

(Station n) ----- (Station 1)

With interface regulator (with gauge)

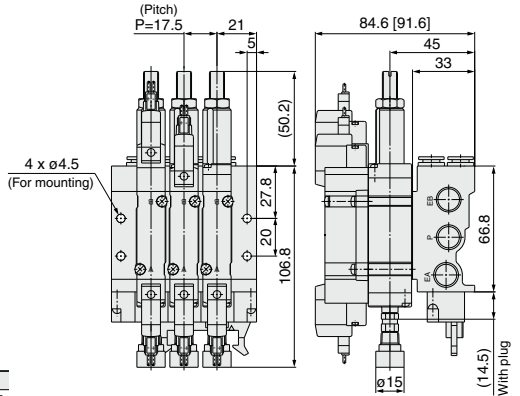
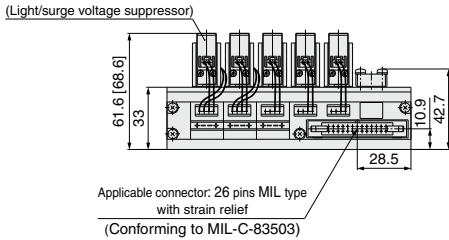

Stations n	3	4	5	6	7	8	9	10	11	12
L1	77	94.5	112	129.5	147	164.5	182	199.5	217	234.5
L2	67	84.5	102	119.5	137	154.5	172	189.5	207	224.5

SY3000: SS5Y3-42P-Stations -01, C4, N3
C6, N7

[] : AC

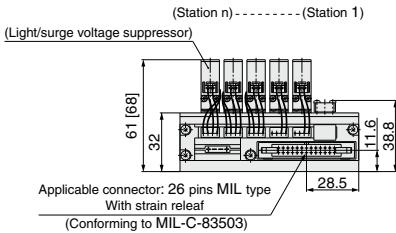
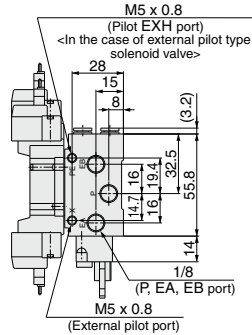
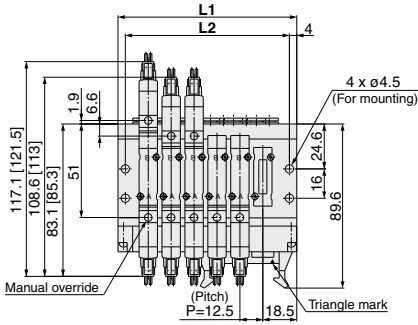
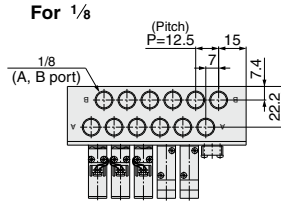
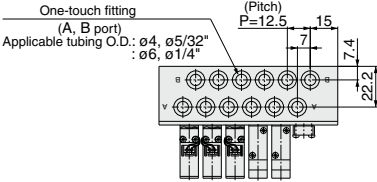

With interface regulator (with gauge)

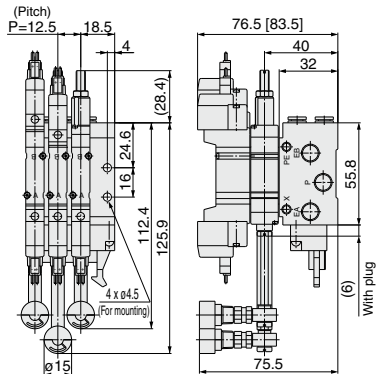

Stations n	4	5	6	7	8	9	10	11	12
L1	72.5	85	97.5	110	122.5	135	147.5	160	172.5
L2	64.5	77	89.5	102	114.5	127	139.5	152	164.5

SJ
SY
SY
S0700
S0700

SY5000: SS5Y5-42P- Stations -02 ^{C6, N7} _{, C8, N9}

[] : AC

Grommet (G)

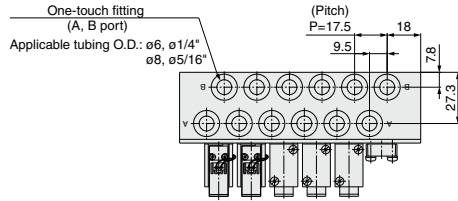

For 1/4

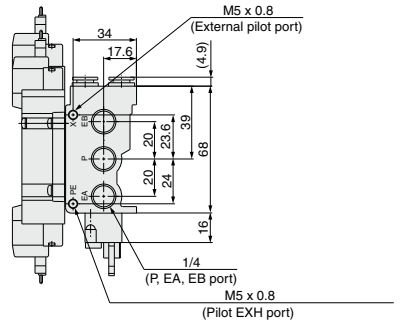
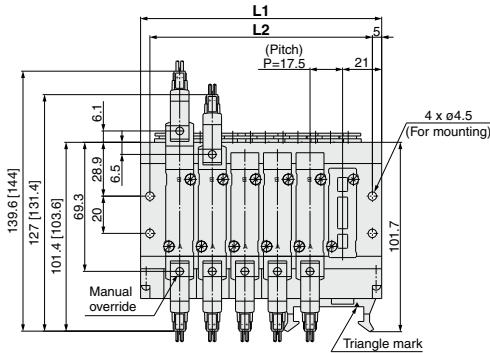
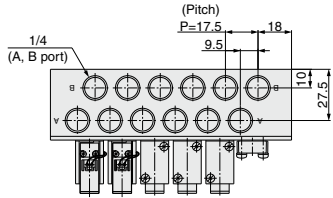

<In the case of external pilot type solenoid valve>

(Station n) ----- (Station 1)
(Light/surge voltage suppressor)

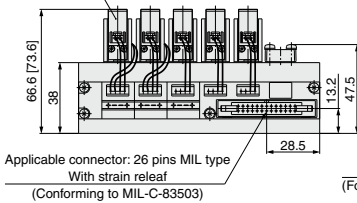

With interface regulator (with gauge)

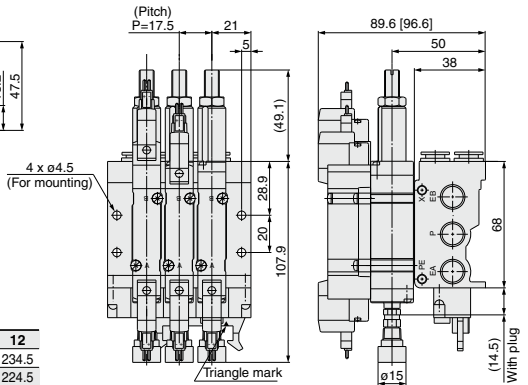

Stations n	3	4	5	6	7	8	9	10	11	12
L1	77	94.5	112	129.5	147	164.5	182	199.5	217	234.5
L2	67	84.5	102	119.5	137	154.5	172	189.5	207	224.5

SY7000: SS5Y7-42P- Stations -02, C10, N11

[]: AC

Grommet (G)

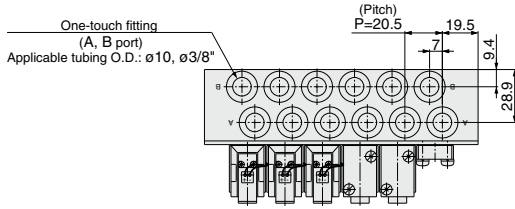

For $1/4$

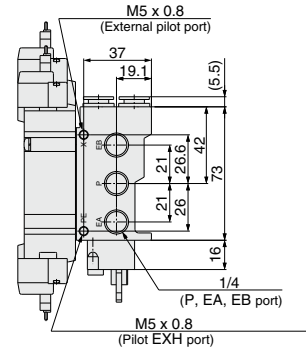
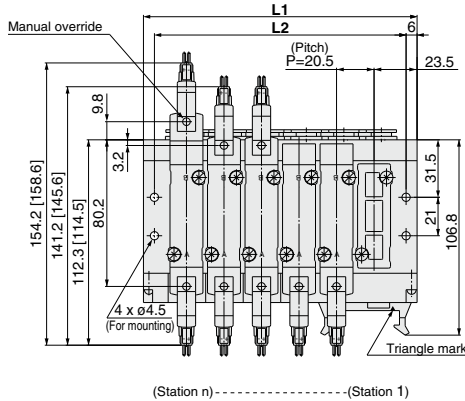
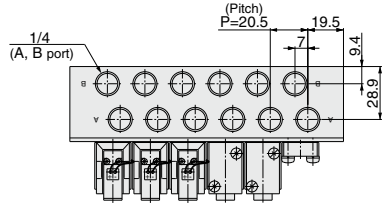

<In the case of external pilot type solenoid valve>

(Light/surge voltage suppressor)

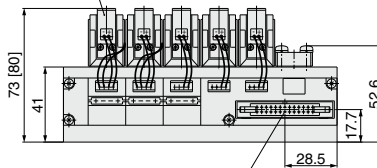

Applicable connector: 26 pins MIL type
With strain relief
(Conforming to MIL-C-83503)

With interface regulator (with gauge)

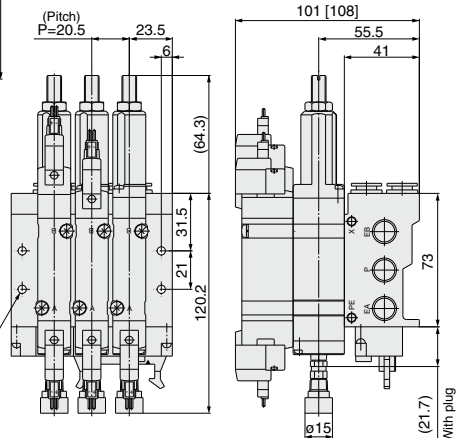

Stations n	3	4	5	6	7	8	9	10	11	12
L1	88	108.5	129	149.5	170	190.5	211	231.5	252	272.5
L2	76	96.5	117	137.5	158	178.5	199	219.5	240	260.5

Type **43P**

5 Port Solenoid Valve Base Mounted Manifold Stacking Type/Flat Ribbon Cable **SY9000 Series**



[Option]
Note) CE-compliant:
For DC only.

How to Order Manifold

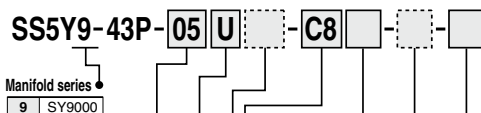

Valve stations

Symbol	Stations
04	4 stations
⋮	⋮
12	12 stations

* This also includes the number of blanking plate assemblies.

P, R port outlets

Symbol	Port outlet	Applicable stations
U	U side	4 to 10 stations
D	D side	4 to 10 stations
B	Both sides	4 to 12 stations

SUP/EXH block assembly specifications

Symbol	Specifications
NII	Standard/Internal pilot specification
R	External pilot specification
S	Internal pilot/Built-in silencer
RS	External pilot/Built-in silencer

Thread type

NII	Rc
F	G
N	NPT
T	NPTF

Option

Symbol	Mounting
NII	Direct mounting
D	DIN rail mounting (with DIN rail)
D0	DIN rail mounting (without DIN rail)
D*	When a longer DIN rail is desired than the specified stations, specify the station number to be required into * mark.

A, B port size

Symbol	Port size
02	1/4
03	3/8

One-touch fitting (Metric size)

Symbol	Port size
C8	One-touch fitting for ø8
C10	One-touch fitting for ø10
C12	One-touch fitting for ø12
M	Mixed

One-touch fitting (Inch size)

Symbol	Port size
N9	One-touch fitting for ø ⁵ / ₁₆ "
N11	One-touch fitting for ø ³ / ₈ "
M	Mixed

* In the case of mixed specifications (M), indicate separately on the manifold specification sheet.

CE-compliant

NII	—
Q	CE-compliant

Note) CE-compliant: For DC only.

How to Order Manifold Assembly (Example)

Example

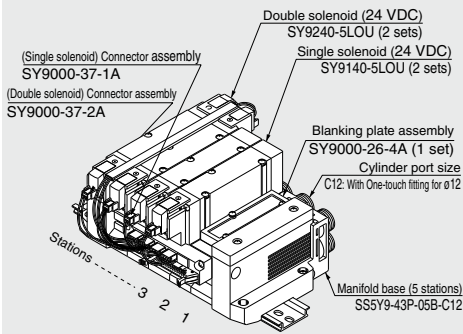

SS5Y9-43P-05B-C12... 1 set (Type 43P, 5-station manifold base part no.)
 * SY9000-26-4A 1 set (Blanking plate assembly part no.)
 * SY9140-5LOU 2 sets (Single solenoid part no.)
 * SY9240-5LOU 2 sets (Double solenoid part no.)
 * SY9000-37-1A 2 sets (Connector assembly part no.)
 * SY9000-37-2A 2 sets (Connector assembly part no.)

The asterisk denotes the symbol for assembly. Prefix it to the part nos. of the solenoid valve, etc.

Add the valve and option part number under the manifold base part number. In the case of complex arrangement, specify them on the manifold specification sheet.

Note) Please indicate the connector assembly part no. (page 515) that connects the valve and the manifold.



Note) CE-compliant:
For DC only. [Option]

How to Order Valve

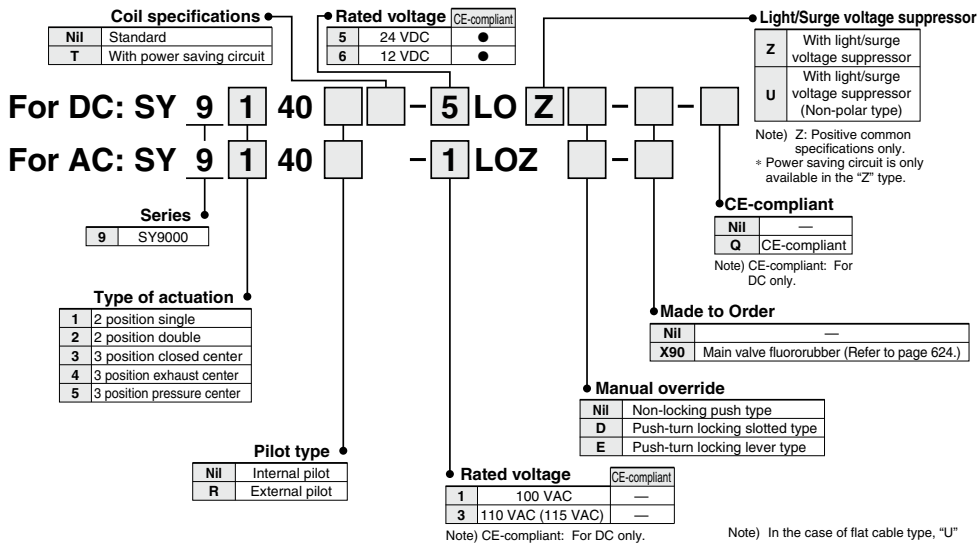

SJ
SY
SY
S0700
S0700

Note) When ordering single unit of the base mounted type solenoid valve, the mounting screws and gaskets for the manifold are included.

Note) In the case of flat cable type, "U" and "Z" types are for DC specifications and "Z" type is for AC specifications. "Z" type for DC is positive common specification only. For the other combination, please contact SMC.

Note) Since the electrical entry is "LO", select an appropriate connector assembly part no.

Connector Assembly

For 12, 24 VDC

Specifications	For SY9000
For single solenoid	SY9000-37-1A
Double solenoid, 3 position type	SY9000-37-2A
Single with spacer assembly	SY9000-37-3A
Double, 3 position with spacer assembly	SY9000-37-4A

Note) Spacer indicates Individual SUP/EXH spacer.

For 100 VAC

Specifications	For SY9000
For single solenoid	SY9000-37-1B
Double solenoid, 3 position type	SY9000-37-2B
Single with spacer assembly	SY9000-37-3B
Double, 3 position with spacer assembly	SY9000-37-4B

For 110 VAC (115 VAC)

Specifications	For SY9000
For single solenoid	SY9000-37-1C
Double solenoid, 3 position type	SY9000-37-2C
Single with spacer assembly	SY9000-37-3C
Double, 3 position with spacer assembly	SY9000-37-4C

- **Multiple valve wiring is simplified through the use of the flat ribbon cable connector.**

• **Clean appearance**

In the case of a flat ribbon cable type, each valve is wired on the print board of manifold base to allow the external wiring to be piped all together with 26 pins MIL connector.

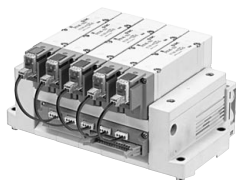

Flat Ribbon Cable Manifold Specifications

Model		SS5Y9-43P	
Applicable valve		SY9□40	
Manifold type		Stacking type	
P (SUP)/R (EXH)		Common SUP, Common EXH	
Valve stations		4 to 12 stations ^{Note 1)}	
A, B port	Location	Base	
	Direction	Side	
Porting specifications	P, EA, EB port	C12 (One-touch fitting for ø12)	
	A, B port	$\frac{1}{4}$ $\frac{3}{8}$ C8 (One-touch fitting for ø8) C10 (One-touch fitting for ø10) C12 (One-touch fitting for ø12)	
Manifold base weight W (g) n: Stations		W = 114n + 343	
Applicable flat ribbon cable connector		Flat ribbon cable connection, Socket: 26 pins MIL with strain relief, Conforming to MIL-C-83503	
Internal wiring		In common between +COM and -COM (Z type: +COM only)	
Rated voltage ^{Note 4)}		12, 24 VDC, 100, 110 VAC	

Note 1) For more than 10 stations, supply pressure to P port on both sides and exhaust from EA/EB port on both sides.

Note 2) The withstand voltage specification for the wiring unit section is JIS C 0704, Grade 1 or its equivalent.

Note 3) Refer to "Manifold Option" on page 530.

Note 4) CE-compliant: For DC only.

Flow Rate Characteristics

Model	Port size		Flow rate characteristics					
	1, 5, 3 (P, EA, EB)	4, 2 (A, B)	1 → 4/2 (P → A/B)			4/2 → 5/3 (A/B → EA/EB)		
			C (dm ³ /s·bar)	b	Cv	C (dm ³ /s·bar)	b	Cv
SS5Y9-43P	C12	C12	6.4	0.29	1.6	7.3	0.29	1.8

Note) The value is for manifold base with 5 stations and individually operated 2 position type.

Internal Wiring of Manifold (Non-polar type)

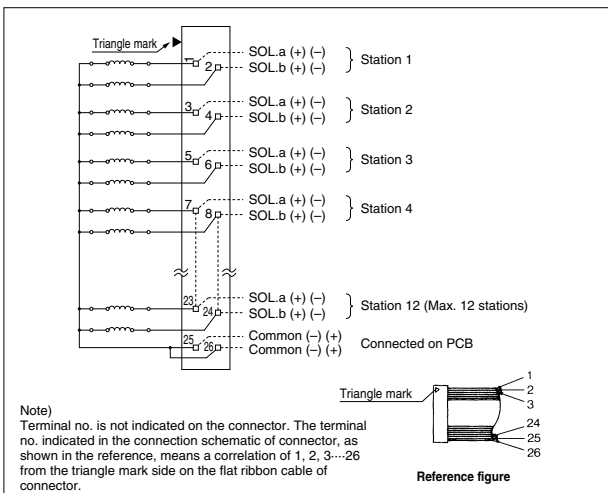

Caution

- For non-polar (U) valves, the electrical DC connections can be used with either positive and negative COM. For type (Z), only use with positive COM as the valve does not operate correctly when used with negative COM.

- For more than 10 stations, both poles of the common should be wired.
- For single solenoid, connect to the solenoid A side.
- The maximum number of stations that can be accommodated is 12. For more stations, please contact SMC.

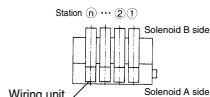

SY9000: SS5Y9-43P-Stations D ^{C8, N9} ₀₂ ^{C10, N11} ₀₃ (-D)

[] : AC

* When P, R port outlets are indicated on the D side, the P, R ports on the opposite side are plugged.

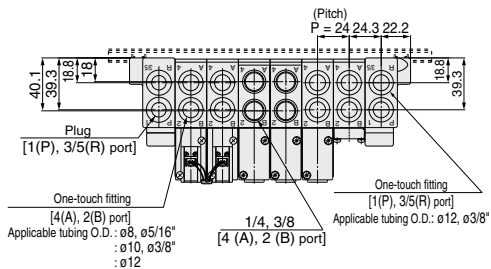

With External Pilot Specifications

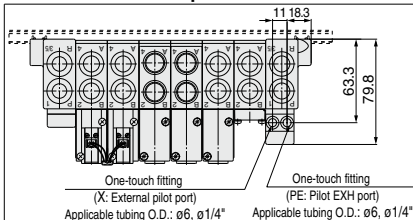

* Air discharge port on the built-in silencer type and the external pilot's extracting position are in the D side.

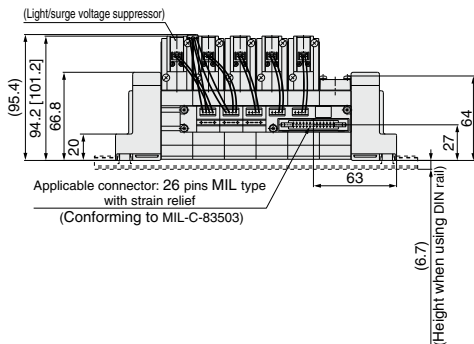
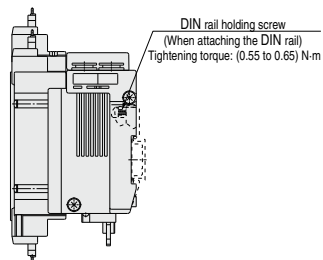
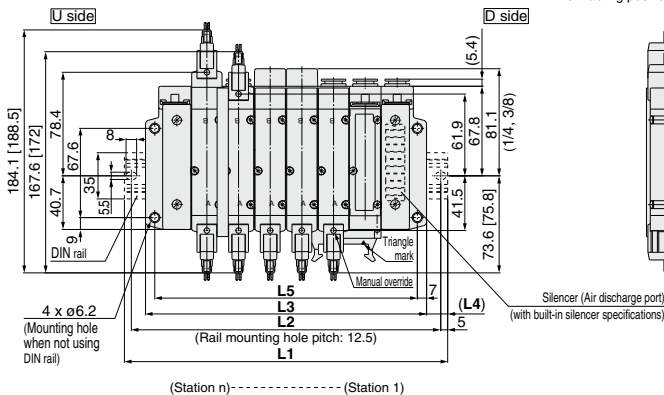

Stations n	4 stations	5	6	7	8	9	10 stations
L1	198	223	248	260.5	285.5	310.5	335.5
L2	187.5	212.5	237.5	250	275	300	325
L3	165	189	213	237	261	285	309
L4	16.5	17	17.5	12	12.5	13	13.5
L5	151	175	199	223	247	271	295

* When P, R port outlets are indicated on the U side, the P, R ports on the opposite side are plugged.

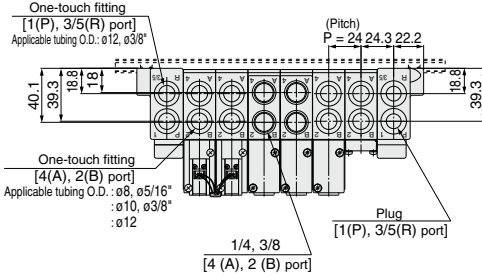

With External Pilot Specifications

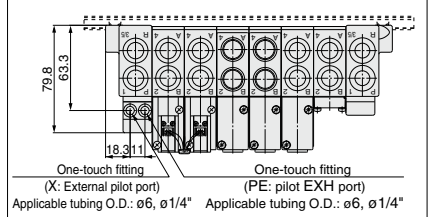

* Air discharge port on the built-in silencer type and the external pilot's extracting position are in the U side.

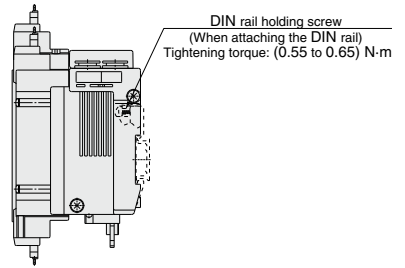
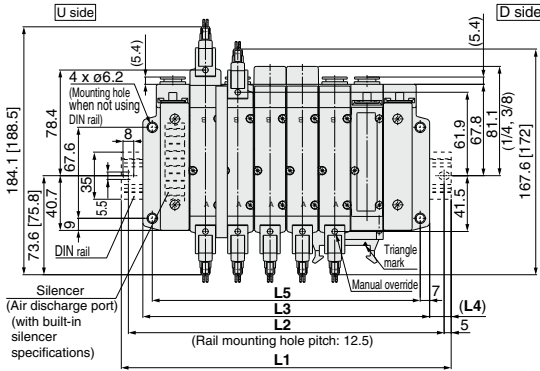

(Station n) ----- (Station 1)

(Light/surge voltage suppressor)

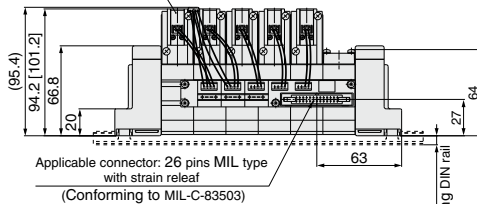

Stations n	4 stations	5	6	7	8	9	10 stations
L1	198	223	248	260.5	285.5	310.5	335.5
L2	187.5	212.5	237.5	250	275	300	325
L3	165	189	213	237	261	285	309
L4	16.5	17	17.5	12	12.5	13	13.5
L5	151	175	199	223	247	271	295

SY9000: SS5Y9-43P- Stations B ⁰² C8, N9 ⁰³ C10, N11 (-D)

[] : AC

* When P, R port outlets are indicated on the B side, the P, R ports on the both sides are in the open state.

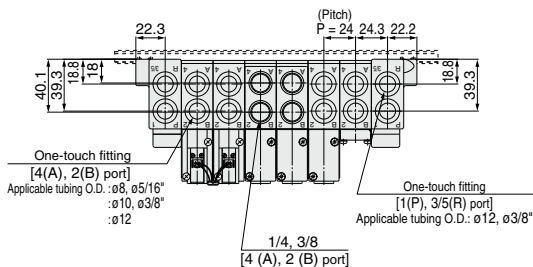

With External Pilot Specifications

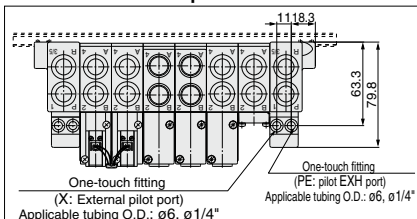

* Air discharge port on the built-in silencer type and the external pilot's extracting position are in the B side (both sides).

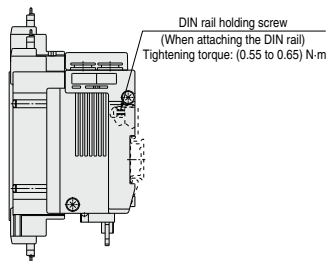
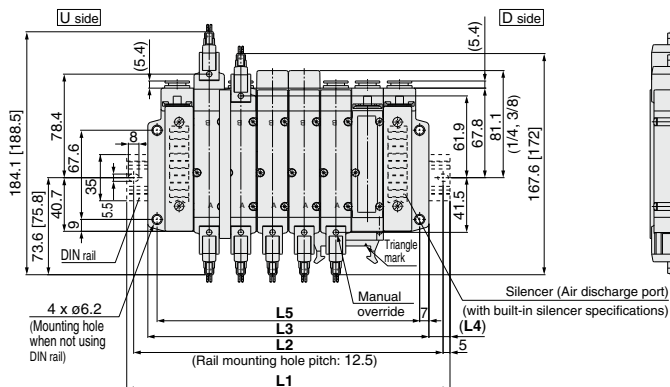

(Station n)------(Station 1)

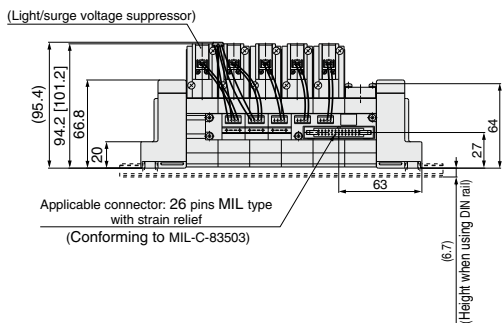

Stations n	4 stations	5	6	7	8	9	10	11	12 stations
L1	198	223	248	260.5	285.5	310.5	335.5	360.5	385.5
L2	187.5	212.5	237.5	250	275	300	325	350	375
L3	165	189	213	237	261	285	309	333	357
L4	16.5	17	17.5	12	12.5	13	13.5	14	14.5
L5	151	175	199	223	247	271	295	319	343

Type **42SA**

EX510 Gateway-type Serial Transmission System Base Mounted Manifold/Integrated Type **SY3000/5000/7000 Series**



How to Order Manifold

SS5Y 3 - 42SA - 03 - 01 - -

Manifold series

3	SY3000
5	SY5000
7	SY7000

SI unit

Nil	NPN output (+COM.)
N	PNP output (-COM.)

CE-compliant

Nil	—
Q	CE-compliant

Thread type

Nil	Rc
F	G
N	NPT
T	NPTF

Valve stations

Symbol	Stations	Note
03	3 stations	Double wiring ^{Note 1)}
:	:	
08	8 stations	Specified layout ^{Note 2)} (Compatible with 16 solenoid valves)
03	3 stations	
:	:	
16	16 stations	

- SS5Y3 can be set from 4 stations.
- The number of the blanking plate assembly is also included.
- Note 1) Double wiring: Use of a single solenoid will result in an unused control signal. If this is not desired, order with a specified layout.
- Note 2) Specified layout: Indicate wiring specifications on the manifold specification sheet. (Note that double and 3 position valves cannot be used where single solenoid wiring has been specified.)

A, B port size

Thread piping

01	1/8	SY3000
02	1/4	SY5000/7000

One-touch fitting (Metric size)

C4	One-touch fitting for ø4	SY3000
C6	One-touch fitting for ø6	SY5000
C8	One-touch fitting for ø8	SY5000
C10	One-touch fitting for ø10	SY7000

One-touch fitting (Inch size)

N3	One-touch fitting for ø5/32"	SY3000
N7	One-touch fitting for ø1/4"	SY5000
N9	One-touch fitting for ø5/16"	SY5000
N11	One-touch fitting for ø3/8"	SY7000

How to Order Manifold Assembly (Example)

Example

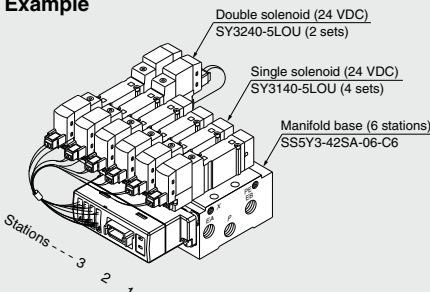

SS5Y3-42SA-06-C6 1 set (42SA type 6-station manifold part no.)
 SY3140-5LOU 4 sets (Single solenoid part no.)
 SY3240-5LOU 2 sets (Double solenoid part no.)

The asterisk denotes the symbol for assembly. Prefix to the part no. of the solenoid valve, etc.

Add the valve and option part number under the manifold base part number. When entry of part numbers becomes complicated, indicate by the manifold specification sheet. For a manifold for an EX510, the length of the lead wire for a connector assembly depends on the number of stations. Therefore, the manifold assembly is shipped with the valves (including blanking plates) and connector assembly mounted on it, as the standard specification. Be sure to specify the part nos. of the solenoid valves to be mounted.

SI unit part no.

Symbol	SI unit specifications	SI unit part no.	Page
Nil	NPN output (+COM.)	EX510-S001	P.897
N	PNP output (-COM.)	EX510-S101	

Refer to page 878 and the Operation Manual for the details of EX510 Gateway-type Serial Transmission System. Please download the Operation Manual via our website, <http://www.smcworld.com>

How to Order Valves

SY 3 1 40 **- 5 LO Z**

Series

3	SY3000
5	SY5000
7	SY7000

Type of actuation

1	2 position single
2	2 position double
3	3 position closed center
4	3 position exhaust center
5	3 position pressure center

Pilot specifications

Nil	Internal pilot
R	External pilot

Coil specifications

Nil	Standard
T	With power saving circuit

CE-compliant

Nil	—
Q	CE-compliant

Made to Order

Nil	—
X90	Main valve fluororubber (Refer to page 624.)

Manual override

Nil	Non-locking push type
D	Push-turn locking slotted type
E	Push-turn locking lever type

Light/Surge voltage suppressor

Z	With light/surge voltage suppressor
U	With light/surge voltage suppressor (non-polar type)

Note 1) Power saving circuit is only available in the "Z" type.

Note 2) When the SI unit is the PNP output (-COM.), only the "U" type is available.

Rated voltage: 24 VDC

SJ
SY
SY
S0700
S0700

Note) When ordering single unit of the base mounted type solenoid valve, the mounting screws and gaskets for the manifold are included.

SY5000: SS5Y5-42SA -Stations-02 C6, N7
C8, N9

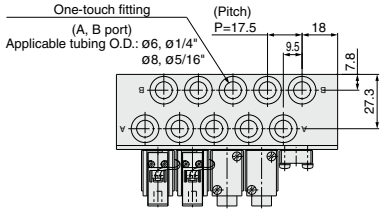

For 1/4

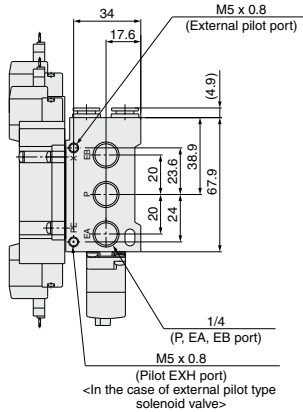
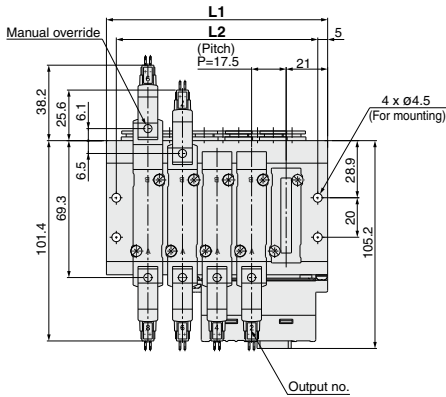
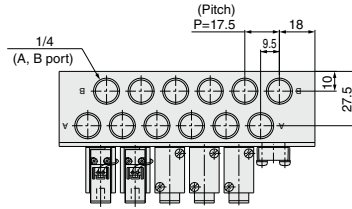

(Station n) ----- (Station 1)

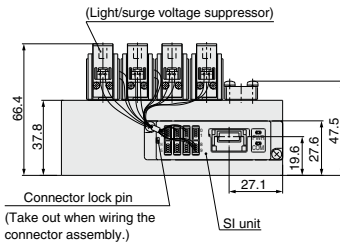

With interface regulator (with gauge)

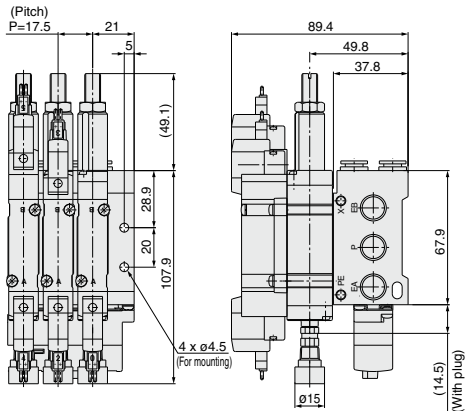

Stations n	3 stations	4	5	6	7	8	9	10	11	12	13	14	15	16 stations
L1	77	94.5	112	129.5	147	164.5	182	199.5	217	234.5	252	269.5	287	304.5
L2	67	84.5	102	119.5	137	154.5	172	189.5	207	224.5	242	259.5	277	294.5

SJ
SY
SY
S0700
S0700

Dimensions

SY7000: SS5Y7-42SA □ - Stations -02 □, C10, N11

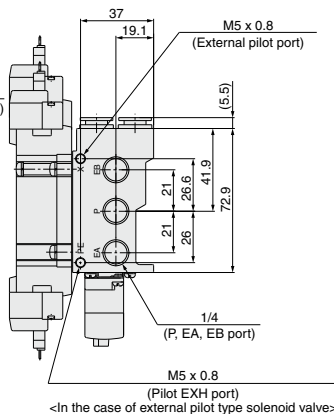
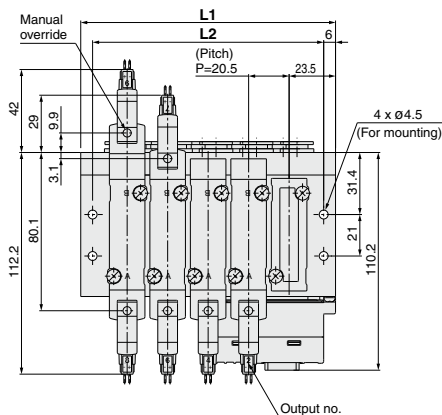
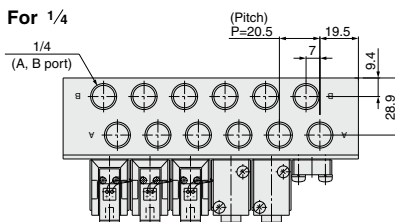
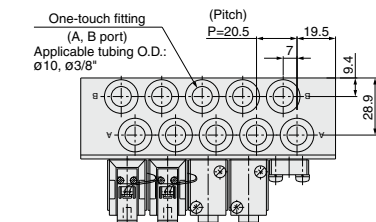

<In the case of external pilot type solenoid valve>

(Station n) ----- (Station 1)

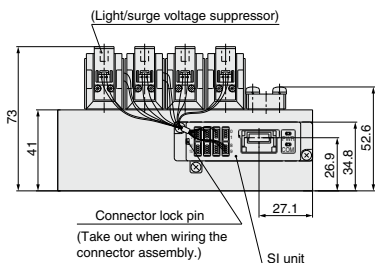

With interface regulator (with gauge)

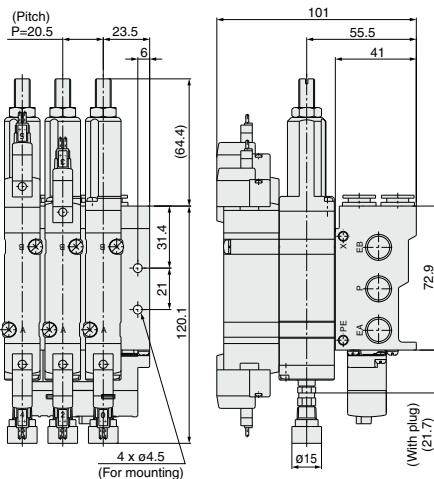

Stations n	3 stations	4	5	6	7	8	9	10	11	12	13	14	15	16 stations
L1	88	108.5	129	149.5	170	190.5	211	231.5	252	272.5	293	313.5	334	354.5
L2	76	96.5	117	137.5	158	178.5	199	219.5	240	260.5	281	301.5	322	342.5

Type **43SA**

EX510 Gateway-type Serial Transmission System Base Mounted Manifold/Stacking Type **SY9000 Series**



How to Order Manifold

SS5Y9 - 43SA [] - **03** **U** [] - **02** [] - [] - []

SI unit

NII	NPN output (+COM.)
N	PNP output (-COM.)

CE-compliant

NII	—
Q	CE-compliant

Valve stations

Symbol	Stations	Note
03	3 stations	Double wiring ^{Note 1)}
⋮	⋮	
08	8 stations	Specified layout ^{Note 2)} (Compatible with 16 solenoid valves)
03	3 stations	
⋮	⋮	
16	16 stations	

- The number of the blanking plate assembly is also included.
- Note 1) Double wiring: Use of a single solenoid will result in an unused control signal. If this is not desired, order with a specified layout.
- Note 2) Specified layout: Indicate wiring specifications on the manifold specification sheet. (Note that double and 3 position valves cannot be used where single solenoid wiring has been specified.)

Option

NII	Direct mounting
D	DIN rail mounting (With DIN rail)
DO	DIN rail mounting (Without DIN rail)
D*	When a longer DIN rail is desired than the specified stations, specify the station number to be required into * mark.

Thread type

NII	Rc
F	G
N	NPT
T	NPTF

A, B port size

Thread piping

02	1/4
03	3/8

One-touch fitting (Metric size)

C8	One-touch fitting for ø8
C10	One-touch fitting for ø10
C12	One-touch fitting for ø12
M	Mixed

One-touch fitting (Inch size)

N9	One-touch fitting for ø5/16"
N11	One-touch fitting for ø3/8"
M	Mixed

- For the mixed specification, indicate separately on a manifold specification sheet.

SUP/EXH block assembly specifications

NII	Standard/Internal pilot
R	External pilot
S	Internal pilot, Built-in silencer
RS	External pilot, Built-in silencer

P, R port outlets

U	U side	3 to 10 stations
D	D side	3 to 10 stations
B	Both sides	3 to 16 stations

SI unit part no.

Symbol	SI unit specifications	SI unit part no.	Page
NII	NPN output (+COM.)	EX510-S001	P.897
N	PNP output (-COM.)	EX510-S101	

Refer to page 878 and the Operation Manual for the details of EX510 Gateway-type Serial Transmission System. Please download the Operation Manual via our website, <http://www.smcworld.com>

How to Order Manifold Assembly (Order Example)

Example

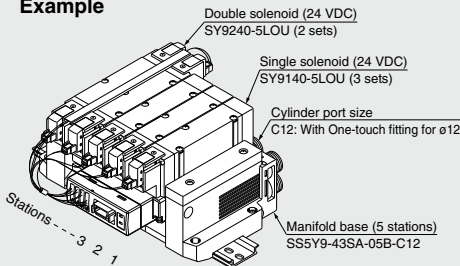

SS5Y9-43SA-05B-C12... 1 set (43SA type 5-station manifold part no.)
SY9140-5LOU **3 sets** (Single solenoid part no.)
SY9240-5LOU **2 sets** (Double solenoid part no.)

—The asterisk denotes the symbol for assembly. Prefix to the part no. of the solenoid valve, etc.

Add the valve and option part number under the manifold base part number. When entry of part numbers becomes complicated, indicate by the manifold specification sheet. For a manifold for an EX510, the length of the lead wire for a connector assembly depends on the number of stations. Therefore, the manifold assembly is shipped with the valves (including blanking plates) and connector assembly mounted on it, as the standard specification. Be sure to specify the part nos. of the solenoid valves to be mounted.

How to Order Valves

SY9 1 **40** **- 5 LO** Z

Type of actuation

1	2 position single
2	2 position double
3	3 position closed center
4	3 position exhaust center
5	3 position pressure center

Pilot specifications

Nii	Internal pilot
R	External pilot

Coil specifications

Nii	Standard
T	With power saving circuit

Rated voltage: 24 VDC

CE-compliant

Nii	—
Q	CE-compliant

Made to Order

Nii	—
X90	Main valve fluororubber (Refer to page 624.)

Manual override

Nii	Non-locking push type
D	Push-turn locking slotted type
E	Push-turn locking lever type

Light/Surge voltage suppressor

Z	With light/surge voltage suppressor
U	With light/surge voltage suppressor (non-polar type)

Note) When ordering single unit of the base mounted type solenoid valve, the mounting screws and gaskets for the manifold are included.

Note 1) Power saving circuit is only available in the "Z" type.

Note 2) When the SI unit is the PNP output (-COM.), only the "U" type is available.

Manifold Option

■ Type 41, 42, 43, 42SA, 43SA Blanking plate assembly

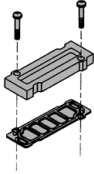

Series	Assembly part no.
SY3000	SY3000-26-9A(-Q)
SY5000	SY5000-26-20A(-Q)
SY7000	SY7000-26-22A(-Q)
SY9000	SY9000-26-2A(-Q)

■ Type 41P, 42P, 43P Blanking plate assembly

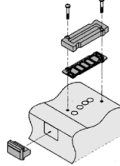

Series	Assembly part no.
SY3000	SY3000-26-10A(-Q)
SY5000	SY5000-26-21A(-Q)
SY7000	SY7000-26-23A(-Q)
SY9000	SY9000-26-4A(-Q)

■ Gasket assembly part no.

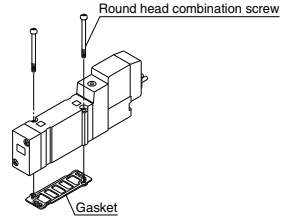

Series	Gasket assembly part no.
SY3000	SY3000-GS-2
SY5000	SY5000-GS-2(-Q)
SY7000	SY7000-GS-2(-Q)
SY9000	SY9000-GS-2

Note) The gasket assembly includes 10 sets of mounting screws and a gasket.

■ Individual SUP spacer assembly

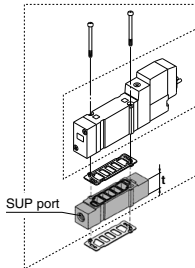

Series	Assembly part no.	Port size	t
SY3000	SY3000-38-2A(-Q)	M5 x 0.8	11
SY5000	SY5000-38-16*A(-Q)	1/8	15
SY7000	SY7000-38-16*A(-Q)	1/4	18
SY9000	SY9000-38-2*A(-Q)	1/4	20

Note) • The SUP port of SY3000, 5000 and 7000 may be either on the lead wire side or on the end plate side. However, as the CE-compliant products (-Q) must be mounted in the specified direction, the port directions cannot be changed. (An assembly is shipped under the condition shown in the figure.)
• For the SY9000, it can only be used on the end plate side.

■ Individual EXH spacer assembly

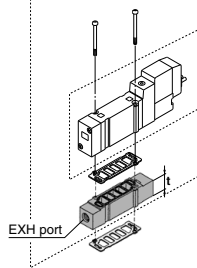

Series	Assembly part no.	Port size	t
SY3000	SY3000-39-2A(-Q)	M5 x 0.8	11
SY5000	SY5000-39-16*A(-Q)	1/8	15
SY7000	SY7000-39-16*A(-Q)	1/4	18
SY9000	SY9000-39-2*A(-Q)	1/4	20

Note) • In case of 41P, 42P and 43P, for protection of the wiring unit section from drainage, piping at the EA port should be arranged so that it will not be directly exposed to exhaust from the valve. However, as the CE-compliant products (-Q) must be mounted in the specified direction, the port directions cannot be changed. (An assembly is shipped under the condition shown in the figure.)
• For the SY9000, it can only be used on the end plate side.

■ Individual SUP spacer assembly + Individual EXH spacer assembly (Double spacer)

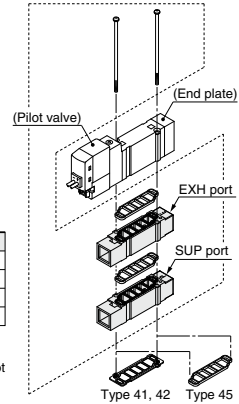

⚠ Caution

Mounting screw tightening torques

M2: 0.16 N·m
M3: 0.8 N·m
M4: 1.4 N·m

* Thread type

NII	Rc
F	G
N	NPT
T	NPTF

⚠ Warning

When mounting a valve or spacer on the manifold base or sub-plate, etc., those mounting directions are determined. If mounted in the wrong direction, the equipment to be connected may cause malfunction. Refer to external dimensions, and then mount it.

●: Available X: Not available —: Not applicable manifold)

Series	Individual SUP + Individual EXP Assemble part no.	Port size	Applicable manifold types						
			41	41P	42	42P	45	45-A 45-N	45*
SY3000	SY3000-120-2A(-Q)	M5 x 0.8	●	X	●	X	●	X	X
SY5000	SY5000-75-1*A(-Q)	1/8	●	X	●	X	●	X	X
SY7000	SY7000-73-1*A(-Q)	1/4	●	X	●	X	—	—	—

Note) The port on a spacer can be directed to the pilot valve side or end plate side. However, as the CE-compliant products (-Q) must be mounted in the specified direction, the port directions cannot be changed. For mounting the port to the pilot valve side, please make sure to connect the ports to protect the pilot valve wiring section from drainage.
The individual SUP spacer and EXH spacer can be mounted either on the upper side or lower side. (The above illustration shows the condition when the product is shipped out from a factory.)

Manifold Option

■ Connector assembly

For single solenoid (SY3000-37-81A-□-N)



For double solenoid (SY3000-37-81A-□-□)

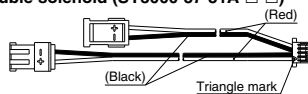

Connector assembly order no. (Can be used for the manifold without a specified layout (8 stations or less))
Integrated type

Model	Part no.	Connector mounting position
SS5Y3-42SA	SY3000-37-81A-3-N	Single: For 1 to 4 stations
	SY3000-37-81A-3-6	Double/3 position: For 1 to 4 stations
	SY3000-37-81A-2-N	Single: For 5 to 8 stations
	SY3000-37-81A-2-4	Double/3 position: For 5 to 8 stations
SS5Y5-42SA	SY3000-37-81A-3-N	Single: For 1 to 8 stations
	SY3000-37-81A-3-6	Double/3 position: For 1 to 8 stations
SS5Y7-42SA	SY3000-37-81A-3-N	Single: For 1 to 4 stations
	SY3000-37-81A-3-6	Double/3 position: For 1 to 4 stations
	SY3000-37-81A-4-N	Single: For 5 to 8 stations
	SY3000-37-81A-4-7	Double/3 position: For 5 to 8 stations

Note) The above is for the station addition or maintenance. When ordering a connector assembly separately, a number would not be printed on the connector.

■ Connector assembly

SY3000-37-80A-□

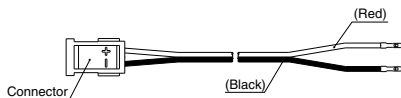

■ Housing (8 pcs./set)

SY3000-44-3A



Connector assembly order no. (Can be used for the manifold with a specified layout)

Model	Part no.	Connector mounting position
SS5Y3-42SA	SY3000-37-80A-3	For A side
	SY3000-37-80A-6	For B side
	SY3000-37-80A-4	For A side
	SY3000-37-80A-7	For B side
SS5Y5-42SA	SY3000-37-80A-3	For A side
	SY3000-37-80A-6	For B side
	SY3000-37-80A-7	For A side
	SY3000-37-80A-9	For B side
SS5Y7-42SA	SY3000-37-80A-4	For A side
	SY3000-37-80A-7	For B side
	SY3000-37-80A-8	For A side
	SY3000-37-80A-11	For B side
SS5Y9-43SA	SY3000-37-80A-6	For A side
	SY3000-37-80A-11	For B side
	SY3000-37-80A-9	For A side
	SY3000-37-80A-14	For B side
	SY3000-37-80A-13	For A side
	SY3000-37-80A-18	For B side

Note 1) The above is for station addition or maintenance. When ordering a connector assembly separately, a number will not be printed on the connector.

Note 2) After inserting the connector assembly into the housing, be sure to confirm that the lead wire will not come off by lightly pulling the wire. Furthermore, do not reuse the lead wire after it has been inserted and removed.

Note 3) Wiring is set longer than the actual wiring distance.

SJ
SY
SY
S0700
S0700

Manifold Option

■ SUP blocking disk (For SY9000)

By installing a SUP blocking disk in the pressure supply passage of a manifold base, it is possible to supply two or more different high and low pressures to one manifold.



Series	No.
SY9000	SY9000-57-1A

■ EXH blocking disk (For SY9000)

By installing an EXH blocking disk in the exhaust passage of a manifold base, it is possible to divide the valve's exhaust so that it does not affect another valve. (Two blocking disks are needed to divide both exhausts.)



Series	No.
SY9000	SY9000-57-1A

■ Label for block disk (For SY9000)

The labels shown below are used on manifold stations containing SUP/EXH block disk(s) to show their location. (3 pcs. each)

VZ3000-123-1A

Label for SUP block disk Label for EXH block disk Label for SUP/EXH block disk



Note) When a block disk is concurrently ordered by specifying on the manifold specification sheet, etc., a label will be stuck on the position where block disk is mounted.

■ Silencer with One-touch fitting (For SY9000)

The silencer plugs directly into the One-touch fittings of the manifold R (exhaust) port.

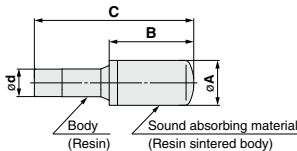

For Series	Model	Effective area mm ²	A	B	C
SY9000 (ø12)	AN30-C12	41	ø20	43.5	71.5

■ DIN Rail Dimensions/Weight for SY9000

VZ1000-11-4-□

● Refer to L dimensions

* Fill in □ with an appropriate no. listed on the table of DIN rail dimensions shown below.

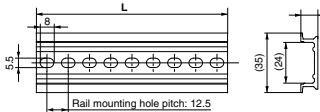

No.	0	1	2	3	4	5	6	7	8	9
L Dimension	98	110.5	123	135.5	148	160.5	173	185.5	198	210.5
Weight (g)	24.8	28	31.1	34.3	37.4	40.6	43.8	46.9	50.1	53.3
No.	10	11	12	13	14	15	16	17	18	19
L Dimension	223	235.5	248	260.5	273	285.5	298	310.5	323	335.5
Weight (g)	56.4	59.6	62.7	65.9	69.1	72.2	75.4	78.6	81.7	84.9
No.	20	21	22	23	24	25	26	27	28	29
L Dimension	348	360.5	373	385.5	398	410.5	423	435.5	448	460.5
Weight (g)	88	91.2	94.4	97.5	100.7	103.9	107	110.2	113.3	116.5

Note) • Refer to page 640 for DIN rail.

• Refer to L1 dimension on pages 503 to 505, 517 to 519 and 527 to 529 for lengths that correspond to the number of manifold stations.

■ Cable assembly (For 41P, 42P, 43P)

AXT100-FC26-¹/₃

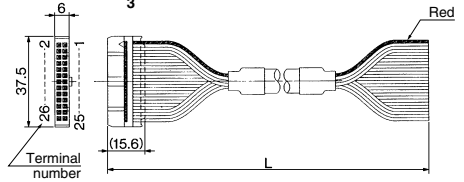

Connector Assembly for Flat Ribbon Cables

Cable length (L)	Assembly part no.	Note
1.5m	AXT100-FC26-1	Cable 26 core x 28 AWG
3m	AXT100-FC26-2	
5m	AXT100-FC26-3	

* For other commercial connectors, use a 26 pins with strain relief conforming to MIL-C-83503.

Connector manufacturers' example

- HIROSE ELECTRIC CO., LTD.
- Japan Aviation Electronics Industry, Limited
- 3M Japan Limited
- J.S.T. Mfg. Co., Ltd.
- Fujitsu Limited

■ Plug

These are inserted in unused cylinder ports and SUP, EXH ports. Purchasing order is available in units of 10 pieces.

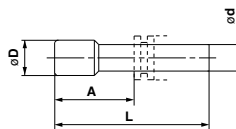

Dimensions

Applicable fittings size øD	Model	A	L	D
4	KQ2P-04	16	32	6
6	KQ2P-06	18	35	8
8	KQ2P-08	20.5	39	10
10	KQ2P-10	22	43	12
12	KQ2P-12	24	44.5	14
1/8"	KQ2P-01	16	31.5	5
5/32"	KQ2P-03	16	32	6
1/4"	KQ2P-07	18	35	8.5
5/16"	KQ2P-09	20.5	39	10
3/8"	KQ2P-11	22	43	11.5

Manifold Option

How to Order Interface Regulator

SY3000 series

ARBY3000-05-P-2

Pressure gauge connection port

05	Pressure gauge (G15-10-01) (for odd number station)
06	Pressure gauge (G15-10-01) (for even number station)
M1	Plug (M-5P)

Regulating port

P	P port
A1	A port (P controlled type, A port regulation)
B1	B port (P controlled type, B port regulation)

Note) In the case of the ARBY3000 series with a pressure gauge when mounting on the manifold, use caution that the part numbers are different between the odd no. stations and the even no. stations to avoid gauges from interfering with each others.

SY5000 series

ARBY5000-00-P-2

Pressure gauge connection port

00	Pressure gauge (G15-10-01)
M1	Plug (M-5P)

Regulating port

P	P port
A1	A port (P controlled type, A port regulation)
B1	B port (P controlled type, B port regulation)

ARBY3000-05-□-2
(For odd number stations)

ARBY3000-06-□-2
(For even number stations)

ARBY3000-M1-□-2

ARBY5000-00-□-2

ARBY5000-M1-□-2

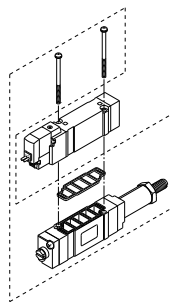
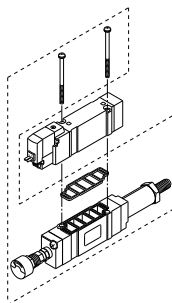
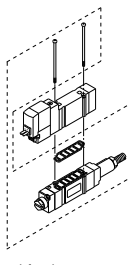
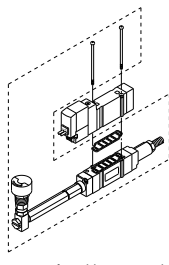
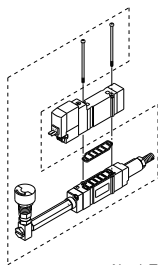

Note) The M8 connector for wiring cannot be mounted for the ARBY3000 series.

SY7000 series

ARBY7000-00-P-2

Pressure gauge connection port

00	Pressure gauge (G15-10-01)
M1	Plug (M-5P)

Regulating port

P	P port
A1	A port (P controlled type, A port regulation)
B1	B port (P controlled type, B port regulation)

Note) ARBY is not CE compliant.

ARBY7000-00-□-2

ARBY7000-M1-□-2

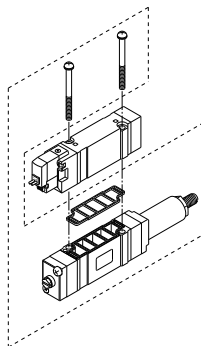
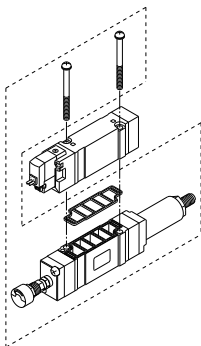

Accessory

Series	Round head combination screw Reference screw size	Gasket
ARBY3000	SY3000-23-10 (M2 x 36)	SX3000-57-4
ARBY5000	AC00283 (M3 x 48.5)	SX5000-57-6
ARBY7000	AC00282 (M4 x 58)	SX7000-57-5

Caution

Mounting screw
tightening torques

- M2: 0.16 N·m
- M3: 0.8 N·m
- M4: 1.4 N·m

Base Mounted Manifold Exploded View

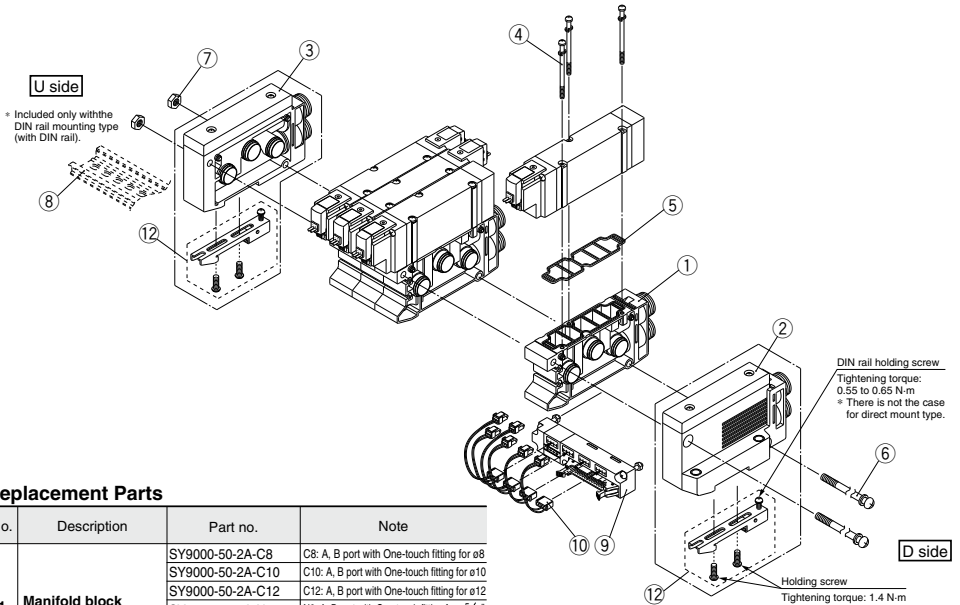

Replacement Parts

No.	Description	Part no.	Note
1	Manifold block assembly	SY9000-50-2A-C8	C8: A, B port with One-touch fitting for ø8
		SY9000-50-2A-C10	C10: A, B port with One-touch fitting for ø10
		SY9000-50-2A-C12	C12: A, B port with One-touch fitting for ø12
		SY9000-50-2A-N9	N9: A, B port with One-touch fitting for ø $\frac{3}{16}$ "
		SY9000-50-2A-N11	N11: A, B port with One-touch fitting for ø $\frac{3}{8}$ "
		SY9000-50-2A-O2*	O2: A, B port $\frac{1}{4}$ " (thread type)
		SY9000-50-2A-O3*	O3: A, B port $\frac{3}{8}$ " (thread type)
4	Round head combination screw	SY9000-18-2	M3 x 42, Matt nickel plated
5	Gasket	SY9000-11-2	
6	Tension bolt	SY9000-23-□	□ at the end of part number corresponds with the number of manifold station. Specify the same number as the number of stations.
7	Hexagon nut	SY9000-25-1	
8	DIN rail	VZ1000-11-4-□	Refer to page 532.
9	Wiring unit assembly	SY9000-36-□A	□ at the end of part number corresponds with the number of manifold station. Specify the same number as the number of stations (4 to 12 stations).
10	Connector assembly	SY9000-37-□□	Refer to page 515.
11	Lead wire cover	SY9000-41-1	
12	Clamp sub assembly	SY9000-30-1A	Included only with the DIN rail mounting type.

⑪ How to assemble lead wire cover

Lead wire cover is only usable for double solenoid valves. Lead wire is inserted into the lead wire cover as magnifying figure, then push it until it touches the valve body.

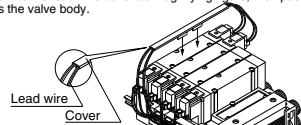

⚠ Caution

For type 43P (Flat cable manifold) of the SY9000 series, the lead wire cover is attached for bundling the lead wires for each solenoid. In case such as adding double solenoid valve, etc., order separately lead wire cover as well.

② SUP/EXH block assembly no. (D side mounting)

• Direct mount type: **SY9000-70-□□A-□□**

• DIN rail mount type: **SY9000-72-□□A-□□**

• **P, R port**

C12	One-touch fitting for ø12
N11	One-touch fitting for ø $\frac{3}{8}$ "
00	Plug

• **Specifications**

1	Internal pilot type
3	External pilot type
4	Internal pilot / Built-in silencer type
5	External pilot / Built-in silencer type

③ SUP/EXH block assembly no. (U side mounting)

• Direct mount type: **SY9000-71-□□A-□□**

• DIN rail mount type: **SY9000-73-□□A-□□**

• **P, R port**

C12	One-touch fitting for ø12
N11	One-touch fitting for ø $\frac{3}{8}$ "
00	Plug

• **Specifications**

1	Internal pilot type
3	External pilot type
4	Internal pilot / Built-in silencer type
5	External pilot / Built-in silencer type

How to Increase Manifold Bases (SY9000 series only) Manifold case can be added at any location.

When a type 43 manifold base is added, tension bolts as well as manifold block assembly will be required. Order the tension bolt suitable for the stations after a station was increased (decreased), since the length of a tension bolt differs by the number of stations. (For changing the number of stations for a type 43P manifold, wiring unit for the stations and lead assembly will be required.)

- 1 Loosen the tension bolts connecting the manifold base, and pull out both of 2 tension bolts.
(When equipped with a DIN rail, loosen one DIN rail holding screw on either U side or D side.)
- 2 Separate the blocks at the location where station expansion is desired.
- 3 Mount additional manifold block assembly.
- 4 Press block-to-block so that there's no gap. After connection, insert a tension bolt for desired stations and then tighten it.
⚠ Caution (Tightening torque: 2.9 N·m)
(When equipped with a DIN rail, be sure to tighten the DIN rail holding screws after tightening the tension bolts. Tightening torque: 0.55 to 0.65 N·m)

⚠ Caution

1. Be sure to shut off the power and air supplies before disassembly. Furthermore, since air may remain inside the actuator, piping and manifold, confirm that the air is completely exhausted before performing any work.
2. When disassembly and assembly are performed, air leakage may result if connections between blocks and tightening of the end block's holding screw, is inadequate.
3. By adding wiring unit assembly to type 43 manifold, it can be changed to type 43P manifold, too.

How to Replace A, B Port Fitting Assembly

By replacing manifold block fitting assemblies or the threaded port block assembly of a type 43(P) manifold, the port size of the A and B ports can be changed. To replace these parts, remove the clip with a flat head screwdriver after the valve has been removed. Insert the fitting assemblies or threaded port block assembly, and then reinsert the clip so that it does not protrude from the manifold block.

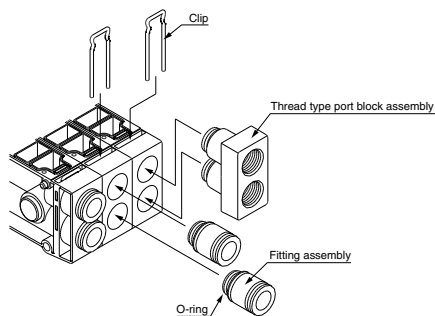

Fitting Assembly Part No.

Port size	No.	Note
One-touch fitting assembly for ø8	VVQ4000-50B-C8	
One-touch fitting assembly for ø10	VVQ4000-50B-C10	
One-touch fitting assembly for ø12	VVQ4000-50B-C12	
One-touch fitting for ø 3/16"	VVQ4000-50B-N9	
One-touch fitting for ø 3/8"	VVQ4000-50B-N11	
1/4 threaded type port block assembly	SY9000-58A-02*	--* at the end of part number denotes the thread type.
3/8 threaded type port block assembly	SY9000-58A-03*	--* at the end of part number denotes the thread type.
Plug assembly	SY9000-62-1A	

Note 1) Be careful to avoid damage or contamination of O-rings, as this can cause air leakage.
 Note 2) Although replacing One-touch fittings of P, R port is also possible, use caution to the cases, etc. in which solenoid valves are often used at the same time by using the smaller sized fittings than the standard size (ø12). Because there may not be able to supply or exhaust air sufficiently in comparison with the valve performances. Besides, although fittings used for A, B port are the same, it is not possible to use the threaded type port block assembly.
 Note 3) The basic order unit of the One-touch fitting is 10 pcs.

5 Port Solenoid Valve Base Mounted Manifold

Note) AC-type models that are CE-compliant have DIN terminals only.



Stacking Type/DIN Rail Mounted/Individual Wiring

Type **45**

SY3000/5000 Series

How to Order Manifold

SS5Y **3** - 45 - **05** **U** - **C6** - [] - []

• **Series**

3	SY3000
5	SY5000

• **Valve stations**

02	2 stations
⋮	⋮
20	20 stations

• **SUP/EXH block assembly mounting position**

Symbol	Mounting position	Applicable no. of stations
U	U side	2 to 10 stations
D	D side	
B	(Both sides)	2 to 20 stations
M*	Special specifications	

* For special specifications, indicate separately by the manifold specification sheet.

• **Option**

When a longer DIN rail is desired than the specified stations, specify the station number to be required. (20 stations at maximum)

• **CE-compliant**

Nil	—
Q	CE-compliant

Note) AC-type models that are CE-compliant have DIN terminals only.

• **A, B port size**

• **One-touch fitting (Metric size)**

Symbol	Port size	Applicable series
C4	One-touch fitting for ø4	SY3000
C6	One-touch fitting for ø6	
M	Mixed	SY5000
C4	One-touch fitting for ø4	
C6	One-touch fitting for ø6	
C8	One-touch fitting for ø8	
M	Mixed	

• **One-touch fitting (Inch size)**

Symbol	Port size	Applicable series
N3	One-touch fitting for ø 5/32"	SY3000
N7	One-touch fitting for ø 1/4"	
M	Mixed	SY5000
N3	One-touch fitting for ø 5/32"	
N7	One-touch fitting for ø 1/4"	
N9	One-touch fitting for ø 5/16"	
M	Mixed	

* In the case of mixed specifications (M), indicate separately on the manifold specification sheet.

* Refer to pages 616 to 620 for external pilot specifications and built-in silencer.

How to Order Manifold Assembly (Example)

Example

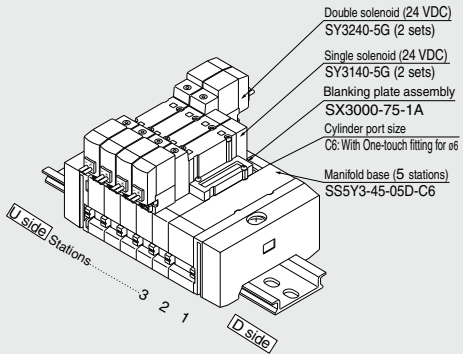

SS5Y3-45-05D-C6 1 set (Type 45, 5-station manifold base part no.)
 * **SX3000-75-1A** 1 set (Blanking plate assembly part no.)
 * **SY3140-5G** 2 sets (Single solenoid part no.)
 * **SY3240-5G** 2 sets (Double solenoid part no.)

The asterisk denotes the symbol for assembly. Prefix it to the part nos. of the solenoid valve, etc.

The valve arrangement is numbered as the 1st. station from D side regardless of the mounting position of SUP/EXH block assembly. In ordering, specify the part nos. in the order from the 1st. station on D side. Besides, when the arrangement will be complicated, fill out the manifold specification sheet to instruct us.



How to Order Valve

Note) AC-type models that are CE-compliant have DIN terminals only.

SY **5** **2** **40** **□** - **5** **L** **□** **□** - **□** - **□**

Series

3	SY3000
5	SY5000

Type of actuation

1	2 position single
2	2 position double
3	3 position closed center
4	3 position exhaust center
5	3 position pressure center

Coil specifications

Nil	Standard
T	With power saving circuit (24, 12 VDC only)

* Power saving circuit is not available in the case of D, Y, DO, YO or W□ type.

Rated voltage

For DC

5	24 VDC
6	12 VDC
V	6 VDC
S	5 VDC
R	3 VDC

AC (Hz)^{50/60}

1	100 VAC
2	200 VAC
3	110 VAC [115 VAC]
4	220 VAC [230 VAC]

* DC specifications of type D, Y, DO and YO is only available with 12 and 24 VDC.
 * For type W□, DC voltage is only available.
 * D and DO only available for SY5000.
 Note) AC-type models that are CE-compliant have DIN terminals only.

CE-compliant

Nil	—
Q	CE-compliant

Note) AC-type models that are CE-compliant have DIN terminals only.

Made to Order

Nil	—
X90	Main valve fluororubber (Refer to page 624.)

Manual override

Nil	Non-locking push type
D	Push-turn locking slotted type
E	Push-turn locking lever type

Light/Surge voltage suppressor

Electrical entry for G, H, L, M, W

Nil	Without light/surge voltage suppressor
S	With surge voltage suppressor
Z	With indicator light and surge voltage suppressor
R	With surge voltage suppressor (Non-polar type)
U	With light/surge voltage suppressor (Non-polar type)

* For AC voltage valves there is no "S" option. It is already built-in to the rectifier circuit.
 * For "R" and "U", DC voltage is only available.
 * Power saving circuit is only available in the "Z" type.

Electrical entry for D, Y

Nil	Without light/surge voltage suppressor
S	With surge voltage suppressor (Non-polar type)
Z	With light/surge voltage suppressor (Non-polar type)

* DOZ and YOZ are not available.
 * For AC voltage valves there is no "S" option. It is already built-in to the rectifier circuit.

Electrical entry

24, 12, 6, 5, 3 VDC/100, 110, 200, 220 VAC			24, 12 VDC 100, 110, 200, 220 VAC	24, 12 VDC 6, 5, 3 VDC
Grommet	L plug connector	M plug connector	DIN terminal	M8 connector
G: Lead wire length 300 mm	L: With lead wire (Length 300 mm)	M: With lead wire (Length 300 mm)	(SY5000) D: With connector	WO: Without connector cable
H: Lead wire length 600 mm	LN: Without lead wire	MN: Without lead wire	DO: Without connector	W□: With connector cable ^{Note 2)}
	LO: Without connector	MO: Without connector	Y: With connector	
			YO: Without connector	
			— ^{Note 1)}	
Manifold mounting	SY3000	●	●	●
	SY5000	●	●	●
CE-compliant	DC	●	●	●
	AC	—	●	—

Note 1) The DIN terminal of the SY3000 series cannot be mounted on a standard manifold. For details, refer to page 639.

Note 2) Enter the cable length symbols in □. Please be sure to fill in the blank referring to page 642.

* LN, MN type: with 2 sockets.

* "Y" type is a DIN terminal conforming to EN-175301-803C (former DIN43650C).

Refer to page 638 for details.

* Refer to page 641 for connector cable of M8 connector.

* M8 connector conforming to IEC60947-5-2 standard is also available. Refer to page 623 for details.

* Refer to page 638 for the lead wire length of L and M plug connectors.

* Refer to page 639 for the connector assembly with cover for L and M plug connectors.

* When ordering single unit of the base mounted type solenoid valve, the mounting screws and gaskets for the integrated manifold are supplied with the solenoid valve, but the stacking type gaskets are not included. When the stacking type gaskets are required, order them separately.



SY
S0700
S0700

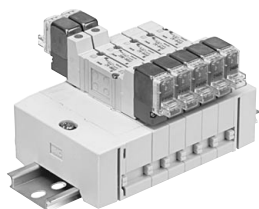

Manifold Specifications

Model	SS5Y3-45(-Q)		SS5Y5-45(-Q)	
Applicable valve	SY3□40		SY5□40	
Manifold type	Stacking type/DIN rail mounted			
P (SUP)/R (EXH)	Common SUP, Common EXH			
Valve stations	2 to 20 stations ^{Note 1)}			
A, B port Porting specifications	Location	Base		
	Direction	Side		
Port size	P, R port	C8 (One-touch fitting for ø8)	C10 (One-touch fitting for ø10)	
	A, B port	C4 (One-touch fitting for ø4) C6 (One-touch fitting for ø6)	C4 (One-touch fitting for ø4) C6 (One-touch fitting for ø6) C8 (One-touch fitting for ø8)	
Manifold base weight W (g), n: Stations	2 to 10 stations: W = 22n + 118 11 to 20 stations: W = 22n + 140		2 to 10 stations: W = 47n + 156 11 to 20 stations: W = 47n + 190	

Note 1) For more than 11 stations, supply pressure to P port on both sides and exhaust from R port on both sides.

Flow Rate Characteristics

Model	Port size		Flow rate characteristics					
	1, 5, 3 (P, EA, EB)	4, 2 (A, B)	1 → 4/2 (P → A/B)			4/2 → 5/3 (A/B → EA/EB)		
			C (dm ³ /s(bar))	b	Cv	C (dm ³ /s(bar))	b	Cv
SS5Y3-45	C8	C6	0.88	0.21	0.22	0.95	0.18	0.22
SS5Y5-45	C10	C8	2.2	0.24	0.53	2.5	0.18	0.58

Note) The value is for manifold base with 5 stations and individually operated 2 position type.

Manifold Option

- Individual SUP spacer assembly ■ Individual EXH spacer assembly ■ SUP blocking disk ■ EXH blocking disk

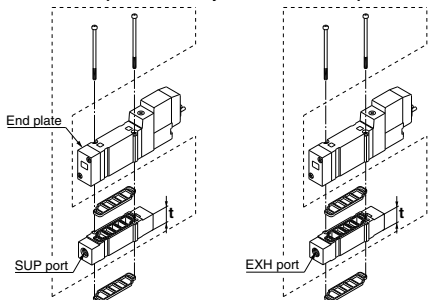

Series	Assembly part no.	Port size	t
SY3000	SY3000-38-2A(-Q)	M5 x 0.8	11
SY5000	SY5000-38-16-A(-Q)	1/8"	15

Note) The SUP port may be either on the lead wire side or on the end plate side. However, as the CE-compliant products (-Q) must be mounted in the specified direction, the port directions cannot be changed. (An assembly is shipped under the condition shown in the figure.)

Series	Assembly part no.	Port size	t
SY3000	SY3000-39-2A(-Q)	M5 x 0.8	11
SY5000	SY5000-39-16-A(-Q)	1/8"	15

Note) The EXH port may be either on the lead wire side or on the end plate side. However, as the CE-compliant products (-Q) must be mounted in the specified direction, the port directions cannot be changed. (An assembly is shipped under the condition shown in the figure.)

■ Blanking plate assembly

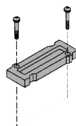

Series	Assembly part no.
SY3000	SX3000-75-1A(-Q)
SY5000	SX5000-76-5A(-Q)

■ Dimensions/DIN rail

VZ1000-11-1-□

● Refer to L dimensions

* Fill in □ with an appropriate no. listed on the table of DIN rail dimensions shown below.

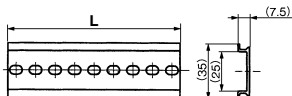

No.	0	1	2	3	4	5	6	7	8	9	10
L Dimension	98	110.5	123	135.5	148	160.5	173	185.5	198	210.5	223
No.	11	12	13	14	15	16	17	18	19	20	21
L Dimension	235.5	248	260.5	273	285.5	298	310.5	323	335.5	348	360.5
L Dimension	372	385.5	398	410.5	423	435.5	448	460.5	473	485.5	498
No.	33	34	35	36	37	38	39	40	41	42	43
L Dimension	510.5	523	535.5	548	560.5	573	585.5	598	610.5	623	635.5
No.	44	45	46	47	48	49	50	51	52	53	54
L Dimension	648	660.5	673	685.5	698	710.5	723	735.5	748	760.5	773
No.	55	56	57	58	59	60	61	62	63	64	65
L Dimension	785.5	798	810.5	823	835.5	848	860.5	873	885.5	898	910.5
No.	66	67	68	69	70	71					
L Dimension	923	935.5	948	960.5	973	985.5					

* Refer to L1 dimension on pages starting with pages 542 to 545 for lengths that correspond to the number of manifold stations.

By installing a SUP blocking disk in the pressure supply passage of a manifold valve, it is possible to supply two or more different high and low pressures to one manifold.



Series	Part no.
SY3000	SX3000-77-1A
SY5000	SX5000-77-1A

By installing an EXH blocking disk in the exhaust passage of a manifold valve, it is possible to divide the valve's exhaust so that it does not affect another valve. (Two blocking disks are needed to divide both exhausts.)



Series	Part no.
SY3000	SX3000-77-1A
SY5000	SX5000-77-1A

■ Label for block disk

The labels shown below are used on manifold stations containing SUP/EXH blocking disk(s) to show their location. (3 pcs. each)

VZ3000-123-1A

Label for SUP block disk Label for EXH block disk Label for SUP/EXH block disk

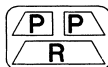

Note) When a block disk is concurrently ordered by specifying on the manifold specification sheet, etc., a label will be stuck on the position where block disk is mounted.

■ Silencer with One-touch fitting

The silencer plugs directly into the One-touch fittings of the manifold.

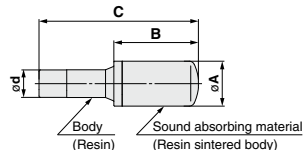

Series	Model	Effective area mm ²	A	B	C
For SY3000 (ø8)	AN15-C08	20	ø13	20	45
For SY5000 (ø10)	AN20-C10	30	ø16.5	30.5	57.5

■ Plug

These are inserted in unused cylinder ports and SUP, EXH ports. Purchasing order is available in units of 10 pieces.

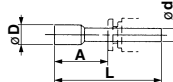

Dimensions

Applicable fittings size øD	Model	A	L	D
4	KQ2P-04	16	32	6
6	KQ2P-06	18	35	8
8	KQ2P-08	20.5	39	10
10	KQ2P-10	22	43	12
1/8"	KQ2P-01	16	31.5	5
5/32"	KQ2P-03	16	32	6
1/4"	KQ2P-07	18	35	8.5
5/16"	KQ2P-09	20.5	39	10

Manifold Option

•How to Order Interface Regulator (SY3000, 5000 only)

SY3000 series

ARBY3000 - **05** - **P** - 2

• **Regulating port**

P	P port
A1	A port (P controlled type, A port regulation)
B1	B port (P controlled type, B port regulation)

• **Pressure gauge connection port**

05	Pressure gauge (G15-10-01) [for odd number station]
06	Pressure gauge (G15-10-01) [for even number station]
M1	Plug (M-5P)

* In the case of the ARBY3000 series with a pressure gauge when mounting on the manifold, use caution that the part numbers are different between the odd no. stations and the even no. stations to avoid gauges from interfering with each others.

SY5000 series

ARBY5000 - **00** - **P** - 2

• **Regulating port**

P	P port
A1	A port (P controlled type, A port regulation)
B1	B port (P controlled type, B port regulation)

• **Pressure gauge connection port**

00	Pressure gauge (G15-10-01)
M1	Plug (M-5P)

ARBY3000-05-□-2
(For mounting odd number stations)

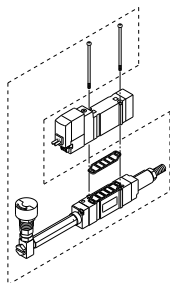

ARBY3000-06-□-2
(For mounting even number stations)

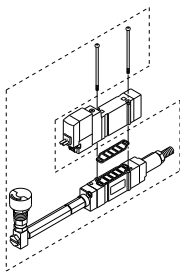

ARBY3000-M1-□-2

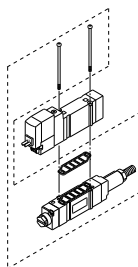

ARBY5000-00-□-2

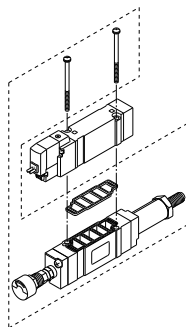

ARBY5000-M1-□-2

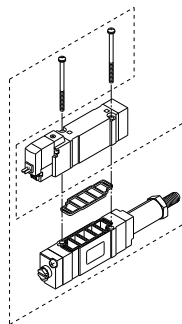

Note) ARBY is not CE-compliant.

Accessory

Series	Round head combination screw Reference screw size	Gasket
ARBY3000	SY3000-23-10 (M2 x 36)	SX3000-57-4
ARBY5000	AC00283 (M3 x 48.5)	SX5000-57-6

⚠ Caution

Mounting screw
tightening torques

M2: 0.16 N·m

M3: 0.8 N·m

SJ
SY
SY
S0700
S0700

Dimensions: SY3000 Series

[] : AC

**SS5Y3-45- Stations D- C4, N3
C6, N7**

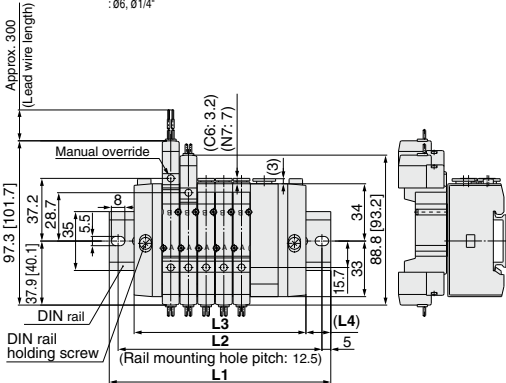
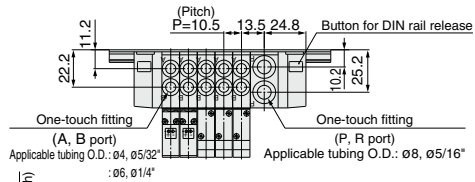

(Station n)- (Station 1)

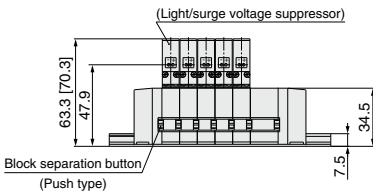

**SS5Y3-45- Stations U- C4, N3
C6, N7**

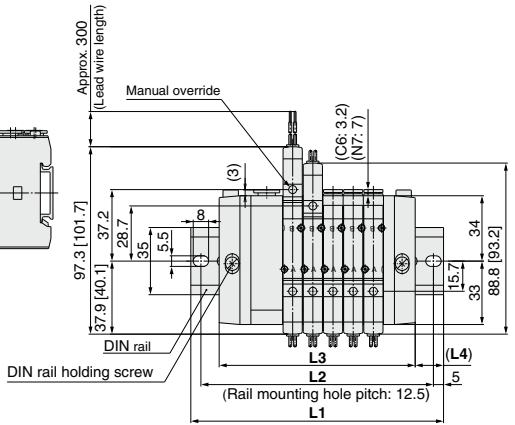
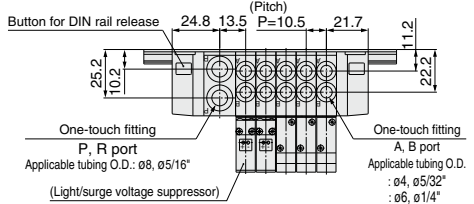

Stations n	2 stations	3	4	5	6	7	8	9	10 stations
L1	98	110.5	123	135.5	148	148	160.5	173	185.5
L2	87.5	100	112.5	125	137.5	137.5	150	162.5	175
L3	70.5	81	91.5	102	112.5	123	133.5	144	154.5
L4	13.5	14.5	15.5	16.5	17.5	12.5	13.5	14.5	15.5

With interface regulator (with gauge)

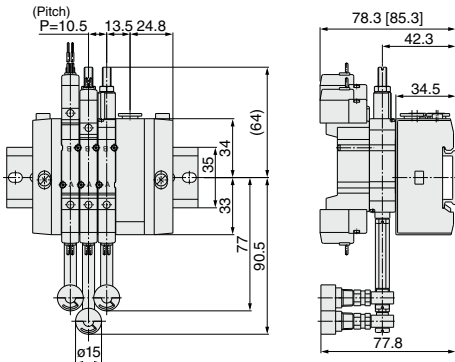

Dimensions: SY5000 Series

[]: AC

SS5Y5-45- Stations D- C4, N3
C6, N7
C8, N9

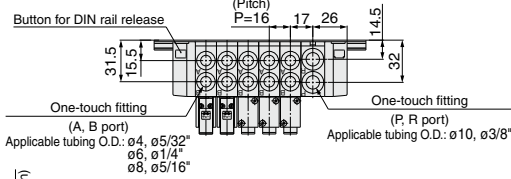

SS5Y5-45- Stations U- C4, N3
C6, N7
C8, N9

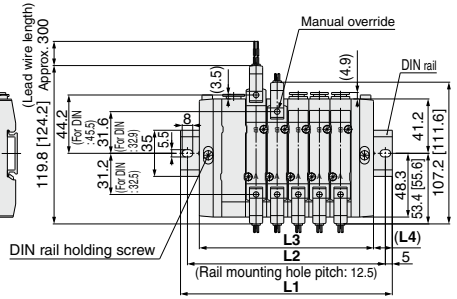
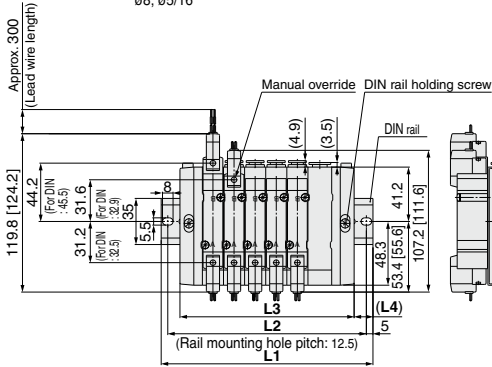
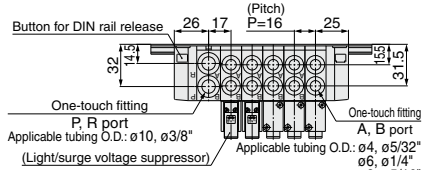

(Station n) --- (Station 1)

(Light/surge voltage suppressor)

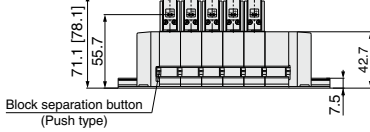

Stations n	2 stations	3	4	5	6	7	8	9	10 stations
L1	110.5	135.5	148	160.5	173	198	210.5	223	235.5
L2	100	125	137.5	150	162.5	187.5	200	212.5	225
L3	84	100	116	132	148	164	180	196	212
L4	13	17.5	16	14	12.5	17	15	13.5	11.5

With interface regulator (with gauge)

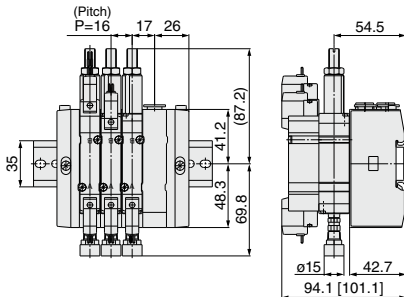

DIN Rail Manifold Exploded View

Type 45

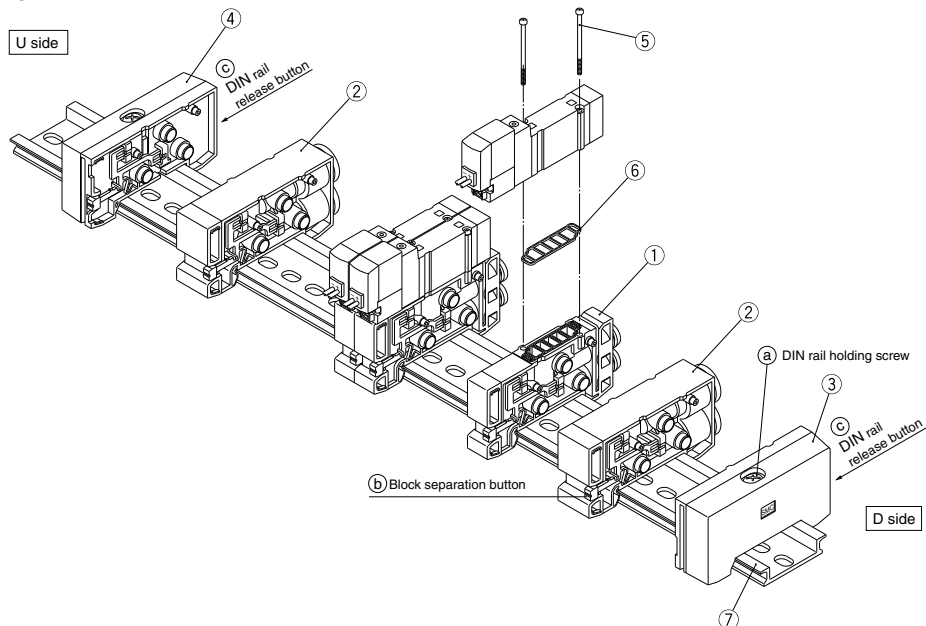

Replacement Parts

No.	Description	Part no.		Note
		SY3000	SY5000	
1	Manifold block assembly	SX3000-50-1A-□□(-Q)	SX5000-50-1A-□□(-Q)	□□: SY3000 (Metric size) C4: With One-touch fitting for ø4 (Inch size) N3: With One-touch fitting for ø5/32" SY5000 (Metric size) C6: With One-touch fitting for ø6 (Inch size) N7: With One-touch fitting for ø1/4" C4: With One-touch fitting for ø4 (Inch size) N3: With One-touch fitting for ø5/32" C6: With One-touch fitting for ø6 (Inch size) N7: With One-touch fitting for ø1/4" C8: With One-touch fitting for ø8 (Inch size) N9: With One-touch fitting for ø5/16" (Gasket 6 is supplied as an accessory.)
2	SUP/EXH block assembly	(Metric size) SX3000-51-1A (Inch size) SX3000-51-15A	(Metric size) SX3000-51-1A (Inch size) SX5000-51-15A	P, R port SY3000 (Metric size) With One-touch fitting for ø8 (Inch size) With One-touch fitting for ø9/16" P, R port SY5000 (Metric size) With One-touch fitting for ø10 (Inch size) With One-touch fitting for ø3/8"
3	End block assembly R	SX3000-52-1A(-Q)	SX5000-52-1A(-Q)	For D side
4	End block assembly L	SX3000-53-1A(-Q)	SX5000-53-1A(-Q)	For U side
5	Round head combination screw Reference screw size	SY3000-23-4 (M2 x 21)	AC00077 (M3 x 26)	
6	Gasket	SX3000-57-4	SX5000-57-6	
7	DIN rail	VZ1000-11-1-□		Refer to page 539.

DIN Rail Manifold Exploded View

How to Increase Manifold Bases Station expansion is possible at any position.

- 1 Loosen DIN rail holding screw ③ fixing the manifold base until it begins to turn idly. (While pressing DIN rail releasing buttons ④, at two locations, separate the manifold base from the DIN rail.)
- 2 Press manifold block assembly dividing button ⑤, that are at the location where manifold bases are to be added, until button ⑥ locks, and then separate the block assemblies.
- 3 Mount additional manifold block assembly on the DIN rail as shown in the figure 1.
- 4 Press the block assemblies until a click sound is produced, and tighten the DIN rail holding screw ③ to fix them to the DIN rail.
⚠ Caution (Tightening torque: 1.4 N·m)
 (While lightly holding the blocks after fixing an end block on one side, tighten the other end block for for better sealing.)

⚠ Caution

Note 1) When there are 10 or fewer manifold block assemblies, and more are added to make a total of 11 or more, a supply/exhaust block assembly must also be added.

Note 2) When disassembly and assembly are performed, air leakage may result if connections between blocks and tightening of the end block's holding screw, is inadequate. Before supplying air, confirm that there are no gaps, etc. between blocks, and that manifold blocks are securely fastened to the DIN rail. Then supply air and confirm that there is no air leakage before operating.

Fig. (1) Block mounting procedure

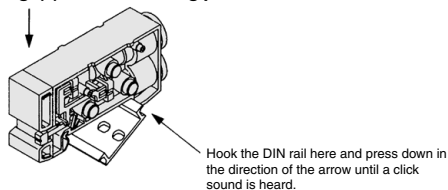

How to Change Fitting Assembly

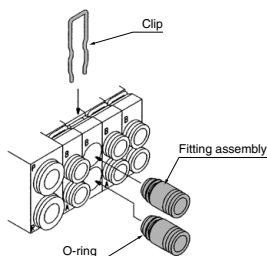

Type 45 manifold permits change in the A and B port sizes by changing the manifold block fitting assembly. After removing the valve, remove the clip with a screwdriver, etc. For mounting a new fitting assembly, insert it and then insert a clip until it will not come out of the manifold block.

Fitting Assembly Part No.

Metric size

SY3000	One-touch fitting for $\phi 4$	VVQ1000-50A-C4
	One-touch fitting for $\phi 6$	VVQ1000-50A-C6
SY5000	One-touch fitting for $\phi 4$	VVQ1000-51A-C4
	One-touch fitting for $\phi 6$	VVQ1000-51A-C6
	One-touch fitting for $\phi 8$	VVQ1000-51A-C8

Inch size

SY3000	One-touch fitting for $\phi 5/32$ "	VVQ1000-50A-N3
	One-touch fitting for $\phi 1/4$ "	VVQ1000-50A-N7
SY5000	One-touch fitting for $\phi 5/32$ "	VVQ1000-51A-N3
	One-touch fitting for $\phi 1/4$ "	VVQ1000-51A-N7
	One-touch fitting for $\phi 5/16$ "	VVQ1000-51A-N9

Note 1) P and R ports cannot be changed.

Note 2) Use caution that O-rings must be free from scratches and dust. Otherwise, air leakage may result.

Note 3) Purchasing order is available in units of 10 pieces.

SJ

SY

SY

S0700

S0700

5 Port Solenoid Valve Base Mounted Manifold Stacking Type/DIN Rail Mounted/Connector Box



Type **45-A**
NA

SY3000/5000 Series

How to Order Manifold

SS5Y **3** -45- **A** **U** -05 **D** -C6 - - -

Series

3	SY3000
5	SY5000

Specifications

Symbol	Specifications
A	With connector box (+COM spec.)
NA	With connector box (-COM spec.)

* The type of attached lead wire assembly is different.

Connector box mounting position

Symbol	Mounting position
U	U side
D	D side

Valve stations

Symbol	Stations	Note
02	2 stations	Applicable up to 16 solenoid valves.
⋮	⋮	
16	16 stations	

SUP/EXH block assembly mounting position

Symbol	Mounting position	Applicable stations
U	U side	2 to 10 stations
D	D side	
B	Both sides	2 to 16 stations
M*	Special specifications	

* For special specifications, indicate separately by the manifold specification sheet.

Option

When a longer DIN rail is desired than the specified stations, specify the station number to be required. (Max. 20 stations)

A/B port size

One-touch fitting (Metric size)

Symbol	Port size	Applicable series
C4	One-touch fitting for ø4	SY3000
C6	One-touch fitting for ø6	
M	Mixed	SY5000
C4	One-touch fitting for ø4	
C6	One-touch fitting for ø6	
C8	One-touch fitting for ø8	
M	Mixed	

One-touch fitting (Inch size)

Symbol	Port size	Applicable series
N3	One-touch fitting for ø ³ / ₃₂ "	SY3000
N7	One-touch fitting for ø ⁷ / ₁₆ "	
M	Mixed	SY5000
N3	One-touch fitting for ø ³ / ₃₂ "	
N7	One-touch fitting for ø ⁷ / ₁₆ "	
N9	One-touch fitting for ø ⁹ / ₁₆ "	
M	Mixed	

* In the case of mixed specifications, indicate separately on the manifold specification sheet.

CE-compliant

NII	—
Q	CE-compliant

* Refer to pages 616 to 620 for external pilot specifications and built-in silencer.

How to Order Manifold Assembly (Example)

Example (SY3000, +COM, U side)

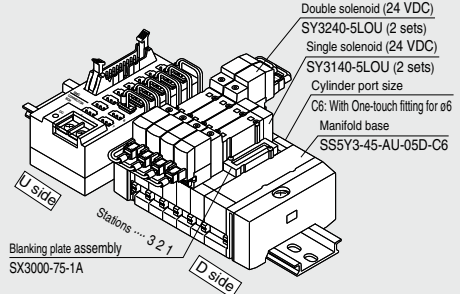

SS5Y3-45-AU-05D-C6 ... 1 set (Type 45, 5-station manifold base part no.)
 * SX3000-75-1A 1 set (Blanking plate assembly part no.)
 * SY3140-5LOU 2 sets (Single solenoid part no.)
 * SY3240-5LOU 2 sets (Double solenoid part no.)

The asterisk denotes the symbol for assembly.
 Prefix it to the part nos. of the solenoid valve, etc.

The valve arrangement is numbered as the 1st. station from D side regardless of the mounting position of connector box. In ordering, specify the part nos. in the order from the 1st. station on D side. Besides, when the arrangement will be complicated, fill out the manifold specification sheet to instruct us.

SS5Y3-45-AU-05D-C6 is assembled with solenoid valve and lead wire assembly when shipping. When ordering manifold only (without valves/wires/options), refer to how to order on page 536 and list the connector box (VZ3000-106-1A) and the rail stopper (TXE1-SMC) below the manifold to allow for the connector box mounting at U side. (Be sure to order DIN rail 3 station longer than number of the manifold stations.) In this case, please note that dimensions, L1 and L2 on pages 552 and 553 may vary slightly.) For other components, refer to page 554.

How to Order Valve

SY **5** **2** 40-5 LOU - - -

Series

3	SY3000
5	SY5000

Rated voltage

5	24 VDC
---	--------

Type of actuation

1	2 position single
2	2 position double
3	3 position closed center
4	3 position exhaust center
5	3 position pressure center

Manual override

NII	Non-locking push type
D	Push-turn locking slotted type
E	Push-turn locking lever type

Made to Order

NII	—
X90	Main valve fluoro rubber (Refer to page 624.)

CE-compliant

NII	—
Q	CE-compliant

* When ordering single unit of the base mounted type solenoid valve, the mounting screws and gaskets for the integrated manifold are supplied with the solenoid valve, but the stacking type gaskets are not included. When the stacking type gaskets are required, order them separately.

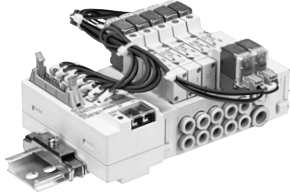

Manifold Specifications

Model	SS5Y3-45^A-NA (Q)		SS5Y5-45^A-NA (Q)	
Applicable valve	SY3□40		SY5□40	
Manifold type	Stacking type/DIN rail mounted			
P (SUP)/R (EXH)	Common SUP, Common EXH			
Valve stations	2 to 16 stations ^{Note 1, 2)}			
A, B port	Base			
	Side			
Porting specifications	Location	Side		
	Direction	Side		
Port size	P, R port	C8 (One-touch fitting for ø8)	C10 (One-touch fitting for ø10)	
	A, B port	C4 (One-touch fitting for ø4) C6 (One-touch fitting for ø6)	C4 (One-touch fitting for ø4) C6 (One-touch fitting for ø6) C8 (One-touch fitting for ø8)	
Manifold base weight W (g)	2 to 10 stations: W = 26n + 207		2 to 10 stations: W = 52n + 245	
n: Stations	11 to 20 stations: W = 26n + 229		11 to 16 stations: W = 52n + 279	
Applicable flat ribbon cable connector	Flat ribbon cable connector Socket: 20 pins MIL type with strain relief conforming to MIL-C-83503			
Wiring specifications	+COM specifications (Type 45-A), -COM specifications (Type 45-NA)			

SJ

SY

SY

S0700

S0700

Note 1) For more than 11 stations, supply pressure to P port on both sides and exhaust from R port on both sides.
 Note 2) There is a limit depending on the number of solenoids. Refer to "How to Order".

Flow Rate Characteristics

Model	Port size		Flow rate characteristics					
	1, 5, 3 (P, EA, EB)	4, 2 (A, B)	1 → 4/2 (P → A/B)			4/2 → 5/3 (A/B → EA/EB)		
			C (dm³/s(bar))	b	Cv	C (dm³/s(bar))	b	Cv
SS5Y3-45-□	C8	C6	0.88	0.21	0.22	0.95	0.18	0.22
SS5Y5-45-□	C10	C8	2.2	0.24	0.53	2.5	0.18	0.58

Note) The value is for manifold base with 5 stations and individually operated 2 position type.

Manifold Wiring Diagram (Circuit diagram for the reference layout)

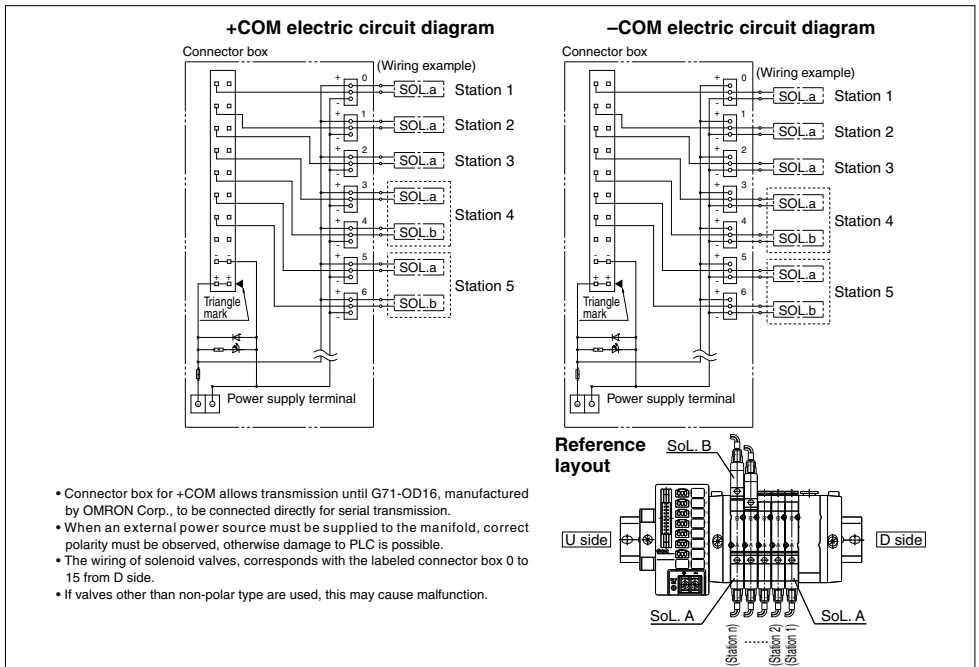

Manifold Option

- Individual SUP spacer assembly
- Individual EXH spacer assembly

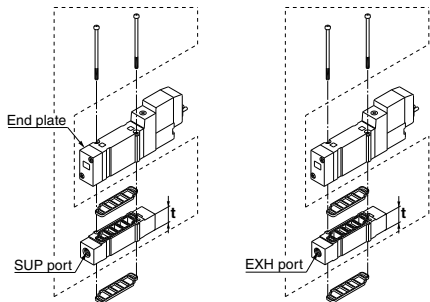

Series	Assembly part no.	Port size	t
SY3000	SY3000-38-2A(-Q)	M5 x 0.8	11
SY5000	SY5000-38-16A(-Q)	1/8"	15

Note) The SUP port may be either on the lead wire side or on the end plate side. However, as the CE-compliant products (-Q) must be mounted in the specified direction, the port directions cannot be changed. (An assembly is shipped under the condition shown in the figure.)

Series	Assembly part no.	Port size	t
SY3000	SY3000-39-2A(-Q)	M5 x 0.8	11
SY5000	SY5000-39-16A(-Q)	1/8"	15

Note) The EXH port may be either on the lead wire side or on the end plate side. However, as the CE-compliant products (-Q) must be mounted in the specified direction, the port directions cannot be changed. (An assembly is shipped under the condition shown in the figure.)

Cable assembly

AXT100-FC20-¹/₃

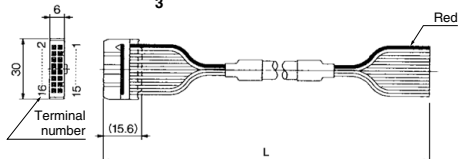

Connector Assembly for Flat Ribbon Cables

Cable length (L)	Assembly part no.	Note
1.5 m	AXT100-FC20-1	Cable 20 core x 22 AWG
3 m	AXT100-FC20-2	
5 m	AXT100-FC20-3	

* For other commercial connectors, use a 20 pins with strain relief conforming to MIL-C-83503.

Connector manufacturers' example

- 3M Japan Limited
- Fujitsu Limited
- Japan Aviation Electronics Industry, Limited
- J.S.T. Mfg. Co., Ltd.

SUP blocking disk

By installing a SUP blocking disk in the pressure supply passage of a manifold valve, it is possible to supply two or more different high and low pressures to one manifold.



Series	Part no.
SY3000	SX3000-77-1A
SY5000	SX5000-77-1A

EXH blocking disk

By installing an EXH blocking disk in the exhaust passage of a manifold valve, it is possible to divide the valve's exhaust so that it does not affect another valve. (Two blocking disks are needed to divide both exhausts.)



Series	Part no.
SY3000	SX3000-77-1A
SY5000	SX5000-77-1A

Label for block disk

The labels shown below are used on manifold stations containing SUP/EXH blocking disk(s) to show their location. (3 pcs. each)

VZ3000-123-1A

Label for SUP blocking disk Label for EXH block disk Label for SUP/EXH block disk

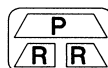

Note) When a block disk is concurrently ordered by specifying on the manifold specification sheet, etc., a label will be stuck on the position where block disk is mounted.

Silencer with One-touch fitting

The silencer plugs directly into the One-touch fittings of the manifold.

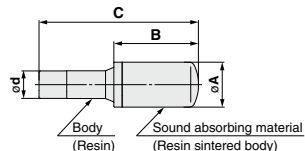

Series	Model	Effective area mm ²	A	B	C
For SY3000 (ø8)	AN15-C08	20	ø13	20	45
For SY5000 (ø10)	AN20-C10	30	ø16.5	30.5	57.5

Plug

These are inserted in unused cylinder ports and SUP, EXH ports. Purchasing order is available in units of 10 pieces.

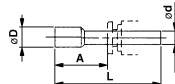

Dimensions

Applicable fittings size ød	Model	A	L	D
4	KQ2P-04	16	32	6
6	KQ2P-06	18	35	8
8	KQ2P-08	20.5	39	10
10	KQ2P-10	22	43	12
1/8"	KQ2P-01	16	31.5	5
5/32"	KQ2P-03	16	32	6
1/4"	KQ2P-07	18	35	8.5
5/16"	KQ2P-09	20.5	39	10

Warning

When mounting a valve or spacer on the manifold base or sub-plate, etc., those mounting directions are determined. If mounted in the wrong direction, the equipment to be connected may cause malfunction. Refer to external dimensions, and then mount it.

Manifold Option

• How to Order Interface regulator (SY3000, 5000 only)

SY3000 series

ARBY3000 - 05 - P - 2

• Regulating port

P	P port
A1	A port (P controlled type, A port regulation)
B1	B port (P controlled type, B port regulation)

• Pressure gauge connection port

05	Pressure gauge (G15-10-01) [for odd number station]
06	Pressure gauge (G15-10-01) [for even number station]
M1	Plug (M-5P)

* In the case of the ARBY3000 series with a pressure gauge when mounting on the manifold, use caution that the part numbers are different between the odd no. stations and the even no. stations to avoid gauges from interfering from each others.

SY5000 series

ARBY5000 - 00 - P - 2

• Regulating port

P	P port
A1	A port (P controlled type, A port regulation)
B1	B port (P controlled type, B port regulation)

• Pressure gauge connection port

00	Pressure gauge (G15-10-01)
M1	Plug (M-5P)

ARBY3000-05-□-2
(For odd number stations)

ARBY3000-06-□-2
(For even number stations)

ARBY3000-M1-□-2

ARBY5000-00-□-2

ARBY5000-M1-□-2

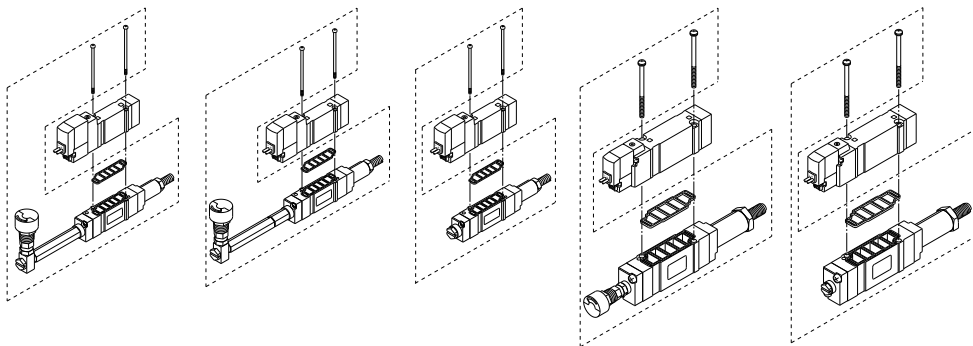

Note) ARBY is not CE-compliant.

Accessory

Series	Round head combination screw Reference screw size	Gasket
ARBY3000	SY3000-23-10 (M2 x 36)	SX3000-57-4
ARBY5000	AC00283 (M3 x 48.5)	SX5000-57-6

⚠ Caution

Mounting screw tightening torques

M2: 0.16 N·m
M3: 0.8 N·m

Dimensions: SY5000 Series

SS5Y5-45-AU- Stations

**D- C4, N3
C6, N7
C8, N9**

One-touch fitting (A, B port)
Applicable tubing O.D.: $\phi 4, \phi 5/32''$
 $\phi 6, \phi 1/4''$
 $\phi 8, \phi 5/16''$

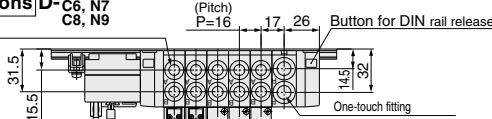

Applicable connector: 20 pins MIL type
With strain relief
(Conforming to MIL-C-83503)

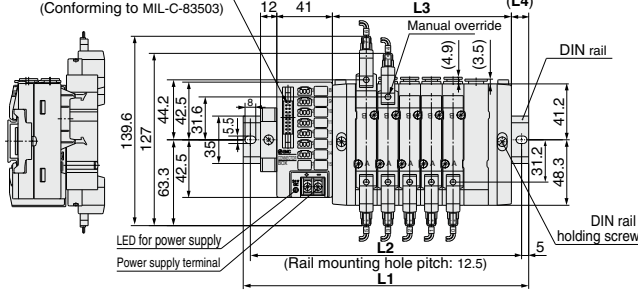

With interface regulator (with gauge)

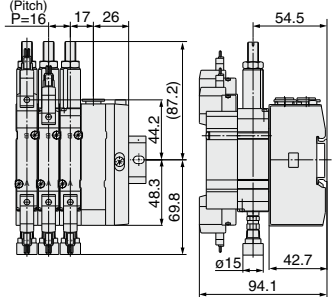

(Light/surge voltage suppressor) (Station n) - - - - (Station 1)

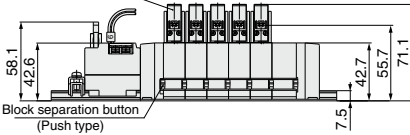

SS5Y5-45-AD- Stations

**U- C4, N3
C6, N7
C8, N9**

One-touch fitting (A, B port)
Applicable tubing O.D.: $\phi 4, \phi 5/32''$
 $\phi 6, \phi 1/4''$
 $\phi 8, \phi 5/16''$

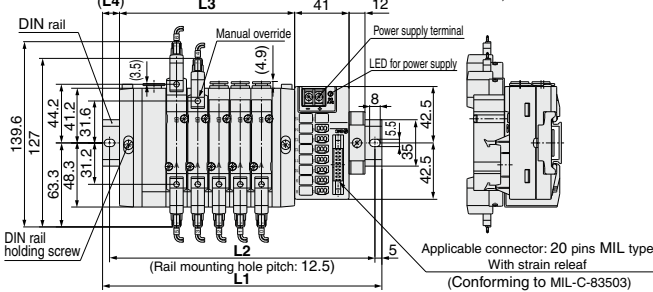
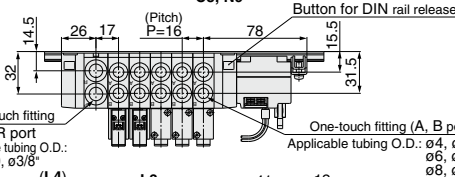

(Light/surge voltage suppressor) (Station n) - - - - (Station 1)

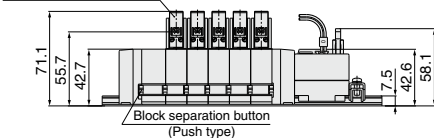

Stations n	2 stations	3	4	5	6	7	8	9	10	11	12	13	14	15	16 stations
L1	160.5	185.5	198	210.5	235.5	248	260.5	273	298	323	348	360.5	373	398	410.5
L2	150	175	187.5	200	225	237.5	250	262.5	287.5	312.5	337.5	350	362.5	387.5	400
L3	84	100	116	132	148	164	180	196	212	246	262	278	294	310	326
L4	11.5	16	14.5	12.5	17	15.5	13.5	12	16.5	12	16.5	14.5	13	17.5	15.5

* Two SUP/EXH blocks are provided for models with 11 stations or more.

DIN Rail Manifold Exploded View

Type 45^A-NA

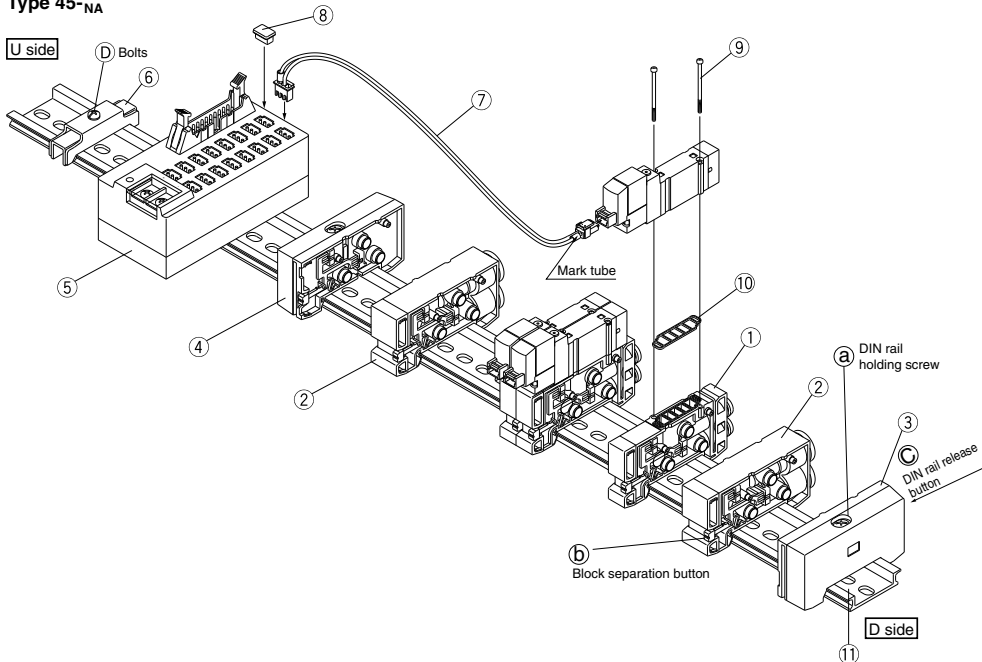

Replacement Parts

No.	Description	Part no.		Note
		SY3000	SY5000	
1	Manifold block assembly	SX3000-50-1A-□□(-Q)	SX5000-50-1A-□□(-Q)	*SY3000 (Metric size) C4: With One-touch fitting for ø4 N3: With One-touch fitting for ø5/32" C6: With One-touch fitting for ø6 N7: With One-touch fitting for ø1/4" *SY5000 (Metric size) C4: With One-touch fitting for ø4 N3: With One-touch fitting for ø5/32" C6: With One-touch fitting for ø6 N7: With One-touch fitting for ø1/4" C8: With One-touch fitting for ø8 N9: With One-touch fitting for ø5/16" (Gasket 10 is supplied as an accessory.)
2	SUP/EXH block assembly	(Metric size) SX3000-51-1A (Inch size) SX3000-51-15A	(Metric size) SX5000-51-1A (Inch size) SX5000-51-15A	P, R port SY3000 (Metric size) With One-touch fitting for ø8 (Inch size) With One-touch fitting for ø5/16" P, R port SY5000 (Metric size) With One-touch fitting for ø10 (Inch size) With One-touch fitting for ø3/8"
3	End block assembly R	SX3000-52-1A(-Q)	SX5000-52-1A(-Q)	For D side
4	End block assembly L	SX3000-53-1A(-Q)	SX5000-53-1A(-Q)	For U side
5	Connector box	VZ3000-106-1A		For 24 VDC only
6	Rail stopper	TXE1-SMC		Made by Kasuga Electric Works
7	Connector assembly	SY3000-43-1A-□	SY3000-43-2A-□	+COM Type D, 2 to 8 stations Type U, 9 to 16 stations SY3000-43-2A-□ SY3000-43-3A-□ +COM Type D, 9 to 16 stations Type U, 2 to 8 stations SY3000-43-1NA-□ SY3000-43-2NA-□ -COM Type D, 2 to 8 stations Type U, 9 to 16 stations SY3000-43-2NA-□ SY3000-43-3NA-□ -COM Type D, 9 to 16 stations Type U, 2 to 8 stations
8	Dust cap	VZ3000-63-2		
9	Round head combination screw	SY3000-23-4	AC00077	
	Reference screw size	(M2 x 21)	(M3 x 26)	
10	Gasket	SX3000-57-4	SX5000-57-6	
11	DIN rail	VZ1000-11-1-□		Refer to page 539.

How to Increase Manifold Bases Station expansion is possible at any position.

- 1 Loosen DIN rail holding screw (A) fixing the manifold base until it begins to turn idly. (While pressing DIN rail releasing buttons (C), at two locations, separate the manifold base from the DIN rail.)
- 2 Press manifold block assembly dividing button (B), that are at the location where manifold bases are to be added, until button (D) locks, and then separate the block assemblies.
- 3 Mount additional manifold block assembly on the DIN rail as shown in the figure 1.
- 4 Press the block assemblies until a click sound is produced, and tighten the DIN rail holding screw (A) to fix them to the DIN rail.
⚠Caution (Tightening torque: 1.4 N·m)
 (While lightly holding the blocks after fixing an end block on one side, tighten the other end block for for better sealing.)
- 5 Untighten the rail stopper bolt (E) to demount the connector box from the DIN rail, and when remounting it, tighten the bolt while pressing it against the rail.

Fig. (1) Block mounting procedure

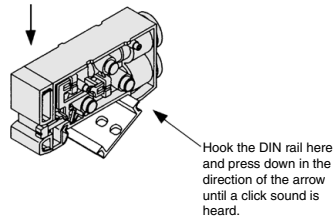

⚠Caution

- Note 1) When there are 10 or fewer manifold block assemblies, and more are added to make a total of 11 or more, a supply/exhaust block assembly must also be added.
- Note 2) When disassembly and assembly are performed, air leakage may result if connections between blocks and tightening of the end block's holding screw, is inadequate. Before supplying air, confirm that there are no gaps, etc. between blocks, and that manifold blocks are securely fastened to the DIN rail. Then supply air and confirm that there is no air leakage before operating.
- Note 3) One connector assembly is necessary for one solenoid.
 When a number is necessary for the connector assembly mark tube, suffix the number to the part no. (0 to 15 are provided as mark tube numbers.)
 Ex) +COM spec.: D type for 2 to 8 stations: No. 10
SY3000-43-1A-10

How to Change Fitting Assembly

Type 45 manifold permits change in the A and B port sizes by changing the manifold block fitting assembly.
 After removing the valve, remove the clip with a screwdriver, etc. For mounting a new fitting assembly, insert it and then insert a clip until it will not come out of the manifold block.

Fitting Assembly Part No.

Metric size

SY3000	One-touch fitting for ø4	VVQ1000-50A-C4
	One-touch fitting for ø6	VVQ1000-50A-C6
SY5000	One-touch fitting for ø4	VVQ1000-51A-C4
	One-touch fitting for ø6	VVQ1000-51A-C6
	One-touch fitting for ø8	VVQ1000-51A-C8

Inch size

SY3000	One-touch fitting for ø5/32"	VVQ1000-50A-N3
	One-touch fitting for ø1/4"	VVQ1000-50A-N7
SY5000	One-touch fitting for ø5/32"	VVQ1000-51A-N3
	One-touch fitting for ø1/4"	VVQ1000-51A-N7
	One-touch fitting for ø5/16"	VVQ1000-51A-N9

- Note 1) P and R ports cannot be changed.
 Note 2) Use caution that O-rings must be free from scratches and dust.
 Otherwise, air leakage may result.
 Note 3) Purchasing order is available in units of 10 pieces.

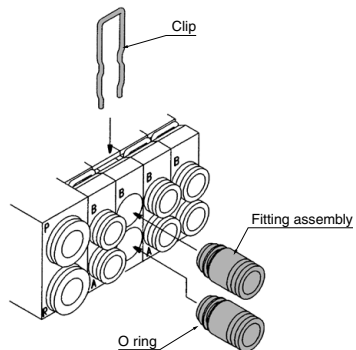

SJ
 SY
 SY
 S0700
 S0700

EX510 Gateway-type Serial Transmission System Base Mounted Manifold/Stacking Type [Option]

SY3000/5000 Series



Type **45S6A**

How to Order Manifold

SS5Y 3 - 45S6A [] U - 02 U [] - C4 - [] - []

Manifold series

3	SY3000
5	SY5000

SI unit

Nil	NPN output (+COM.)
N	PNP output (-COM.)

CE-compliant

Nil	—
Q	CE-compliant

SI unit mounting position

U	U side
D	D side

Valve stations

Symbol	Stations	Note
02	2 stations	Double wiring ^{Note 1)}
:	:	
08	8 stations	Specified layout ^{Note 2)} (Compatible with 16 solenoid valves)
02	2 stations	
:	:	
16	16 stations	

• The number of the blanking plate assembly is also included.
 Note 1) Double wiring: Use of a single solenoid will result in an unused control signal. If this is not desired, order with a specified layout.
 Note 2) Specified layout: Indicate wiring specifications on the manifold specification sheet. (Note that double and 3 position valves cannot be used where single solenoid wiring has been specified.)

Option

When a DIN rail that is longer than the specified stations is desired, specify the required station number. (Max. 20 stations)

A, B port size

One-touch fitting (Metric size)

Symbol	One-touch fitting	Series
C4	One-touch fitting for ø4	SY3000
C6	One-touch fitting for ø6	
M	Mixed	
C4	One-touch fitting for ø4	SY5000
C6	One-touch fitting for ø6	
C8	One-touch fitting for ø8	
M	Mixed	

One-touch fitting (Inch size)

Symbol	One-touch fitting	Series
N3	One-touch fitting for ø5/32"	SY3000
N7	One-touch fitting for ø1/4"	
M	Mixed	
N3	One-touch fitting for ø5/32"	SY5000
N7	One-touch fitting for ø1/4"	
N9	One-touch fitting for ø5/16"	
M	Mixed	

• For the mixed specification, indicate separately on a manifold specification sheet.

Pilot specifications

Nil	Internal pilot
S	Internal pilot/built-in silencer
R	External pilot
RS	External pilot/built-in silencer

SUP/EXH block assembly mounting position

U	U side	2 to 10 stations
D	D side	
B	Both sides	2 to 16 stations
M	Special specifications*	

*For the special specifications, indicate separately on a manifold specification sheet.

How to Order Manifold Assembly (Order Example)

Example

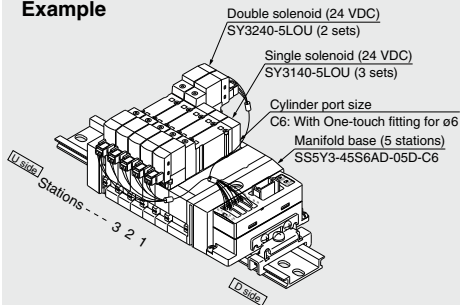

SS5Y3-45S6AD-05D-C6 ... 1 set (45S6A type 5-station manifold part no.)
 • SY3140-5LOU 3 sets (Single solenoid part no.)
 • SY3240-5LOU 2 sets (Double solenoid part no.)

—The asterisk denotes the symbol for assembly. Prefix to the part no. of the solenoid valve, etc.

Add the valve and option part number under the manifold base part number. When entry of part numbers becomes complicated, indicate by the manifold specification sheet. For a manifold for an EX510, the length of the lead wire for a connector assembly depends on the number of stations. Therefore, the manifold assembly is shipped with the valves (including blanking plates) and connector assembly mounted on it, as the standard specification. Be sure to specify the part nos. of the solenoid valves to be mounted.

SI unit part no.

Symbol	SI unit specifications	SI unit part no.	Page
Nil	NPN output (+COM.)	EX510-S001	P.897
N	PNP output (-COM.)	EX510-S101	

Refer to page 878 and the Operation Manual for the details of EX510 Gateway-type Serial Transmission System. Please download the Operation Manual via our website, <http://www.smcworld.com>



How to Order Valves

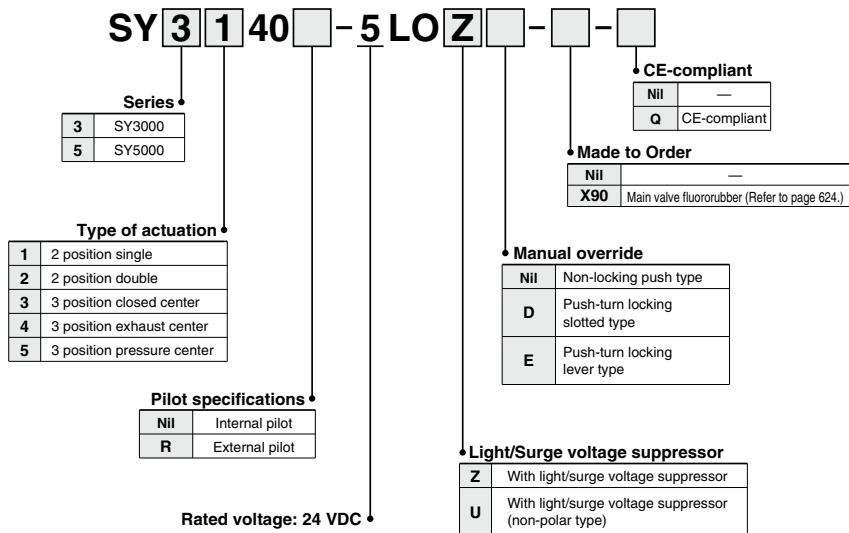

SJ
SY
SY
S0700
S0700

* When ordering single unit of the base mounted type solenoid valve, the mounting screws and gaskets for the integrated manifold are supplied with the solenoid valve, but the stacking type gaskets are not included. When the stacking type gaskets are required, order them separately.

Dimensions

SY3000: SS5Y3-45S6A □ D- Stations U-C4, N3
C6, N7

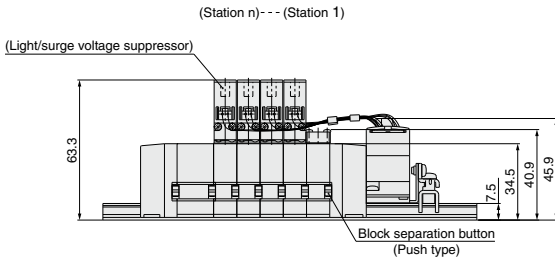
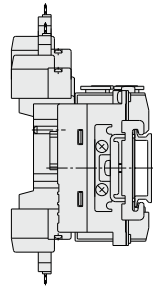
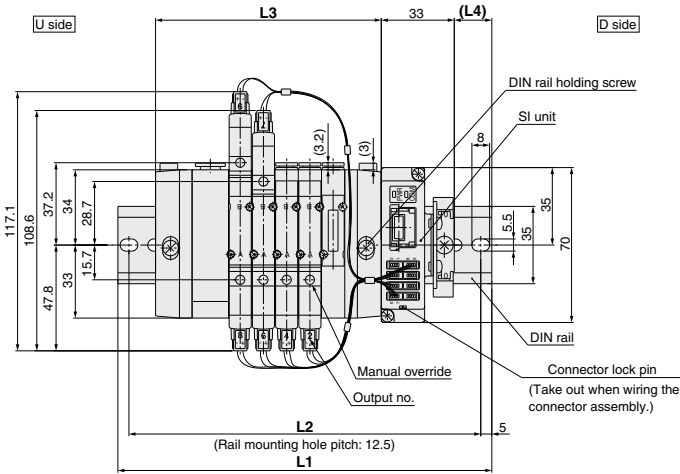
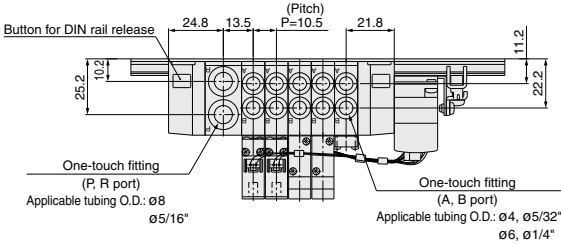

Stations n	2 stations	3	4	5	6	7	8	9	10 stations
L1	135.5	148	148	160.5	173	185.5	198	210.5	223
L2	125	137.5	137.5	150	162.5	175	187.5	200	212.5
L3	70.5	81	91.5	102	112.5	123	133.5	144	154.5
L4	16	17	12	13	14	15	16	17	18

SY3000: SS5Y3-45S6A U-Stations B-C4, N3
C6, N7

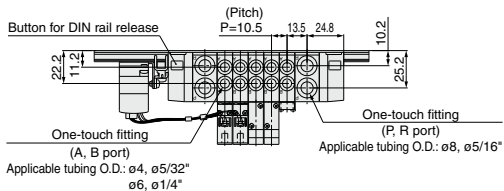

SJ
SY
SY
S0700
S0700

With interface regulator (with gauge)

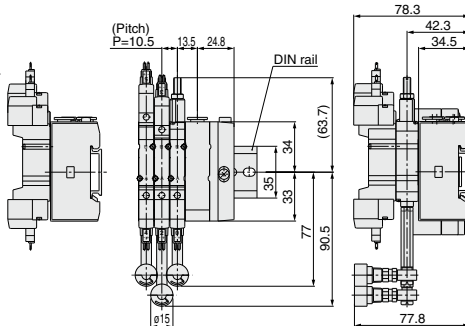
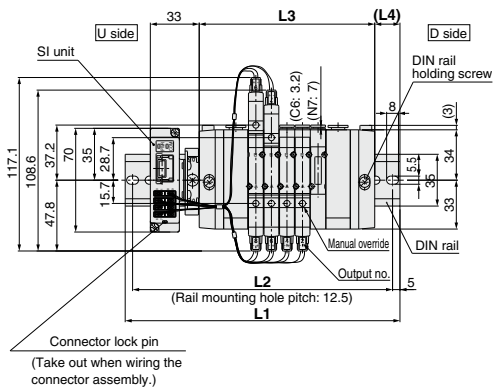

(Station n) --- (Station 1)

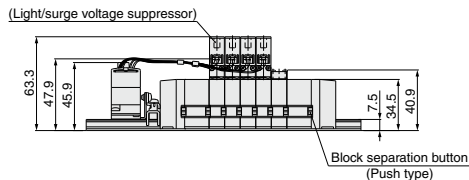

Stations n	2 stations	3	4	5	6	7	8	9	10	11	12	13	14	15	16 stations
L1	148	160.5	173	185.5	185.5	198	210.5	223	235.5	248	260.5	260.5	273	285.5	298
L2	137.5	150	162.5	175	175	187.5	200	212.5	225	237.5	250	250	262.5	275	287.5
L3	87	97.5	108	118.5	129	139.5	150	160.5	171	181.5	192	202.5	213	223.5	234
L4	14	15	16	17	12	13	14	15	16	17	18	12.5	13.5	14.5	15.5

Dimensions

SY5000: SS5Y5-45S6A □ **D-Stations U-** C4, N3
C6, N7
C8, N9

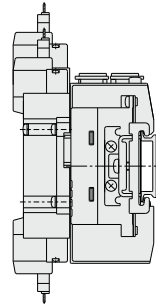
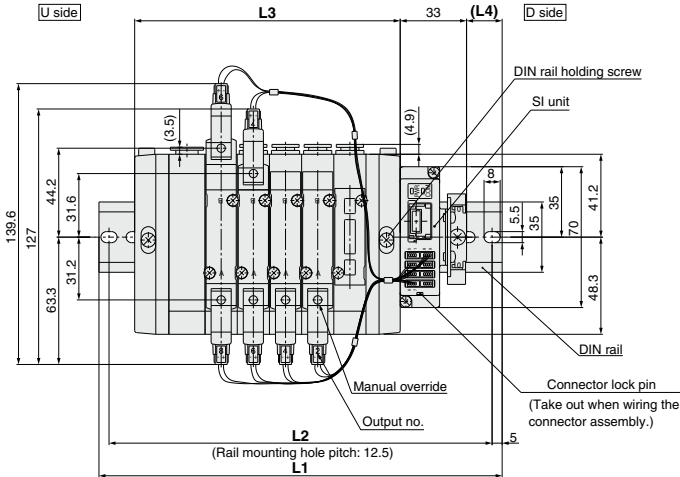
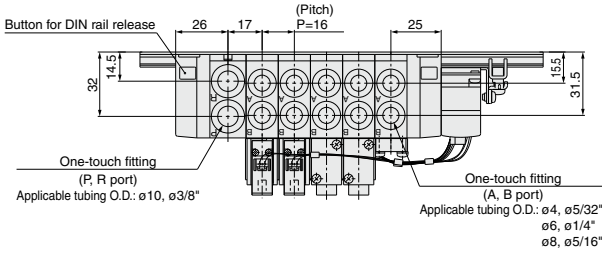

(Station n) --- (Station 1)

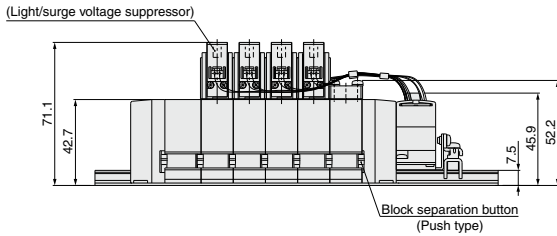

Stations n	2 stations	3	4	5	6	7	8	9	10 stations
L1	148	160.5	173	198	210.5	223	248	260.5	273
L2	137.5	150	162.5	187.5	200	212.5	237.5	250	262.5
L3	84	100	116	132	148	164	180	196	212
L4	15.5	14	12	16.5	15	13	17.5	16	14

SY5000: SS5Y5-45S6A □ **U- Stations B-** C4, N3
C6, N7
C8, N9

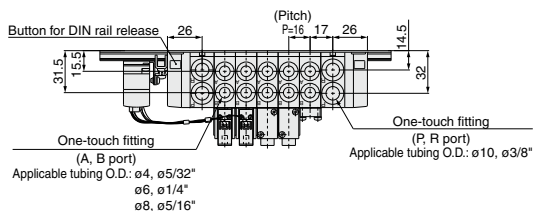

With interface regulator (with gauge)

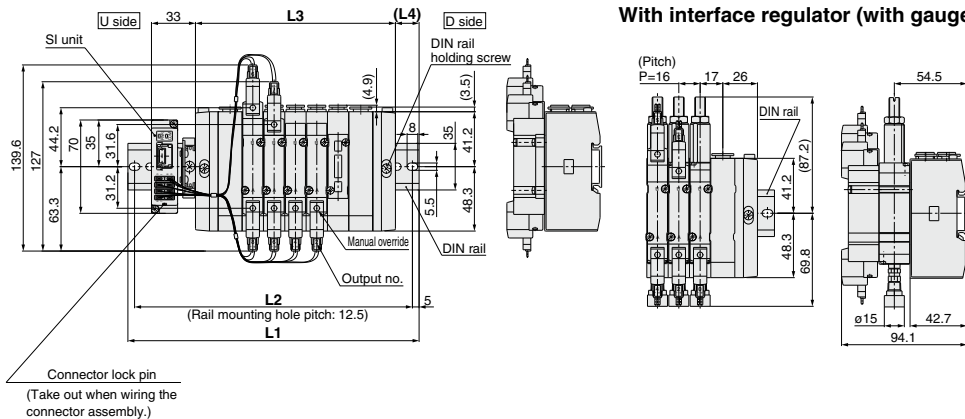

Stations n	2 stations	3	4	5	6	7	8	9	10	11	12	13	14	15	16 stations
L1	160.5	185.5	198	210.5	223	248	260.5	273	298	310.5	323	335.5	360.5	373	385.5
L2	150	175	187.5	200	212.5	237.5	250	262.5	287.5	300	312.5	325	350	362.5	375
L3	102	118	134	150	166	182	198	214	230	246	262	278	294	310	326
L4	13	17.5	15.5	14	12	16.5	15	13	17.5	16	14	12.5	17	15	13.5

SJ
SY
SY
S0700
S0700

Manifold Option

■ Connector assembly

For single solenoid (SY3000-37-81A-□-□)

For double solenoid (SY3000-37-81A-□-□)

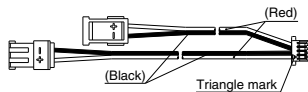
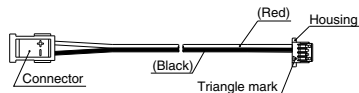

Connector assembly order no. (Can be used for the manifold without a specified layout (8 stations or less))
Integrated type

Model	Part no.	Connector mounting position	
SS5Y3-45S6A	SY3000-37-81A-3-N	Single	: Starting from the SI unit side From unit 1 to unit 4
	SY3000-37-81A-3-3	Double/3 position	: Starting from the SI unit side From unit 1 to unit 4
	SY3000-37-81A-4-N	Single	: Starting from the SI unit side From unit 5 to unit 8
	SY3000-37-81A-4-4	Double/3 position	: Starting from the SI unit side From unit 5 to unit 8
SS5Y5-45S6A	SY3000-37-81A-4-N	Single	: Starting from the SI unit side From unit 1 to unit 4
	SY3000-37-81A-4-4	Double/3 position	: Starting from the SI unit side From unit 1 to unit 4
	SY3000-37-81A-6-N	Single	: Starting from the SI unit side From unit 5 to unit 8
	SY3000-37-81A-6-6	Double/3 position	: Starting from the SI unit side From unit 5 to unit 8
SS5Y9- ²³ SA	SY3000-37-81A-4-N	Single	: For 1 to 4 stations
	SY3000-37-81A-4-9	Double/3 position	: For 1 to 4 stations
	SY3000-37-81A-6-N	Single	: For 5 to 8 stations
	SY3000-37-81A-6-11	Double/3 position	: For 5 to 8 stations

Note) The above is for the station addition or maintenance. When ordering a connector assembly separately, a number would not be printed on the connector.

■ Connector assembly

SY3000-37-80A-□

■ Housing (8 pcs./set)

SY3000-44-3A

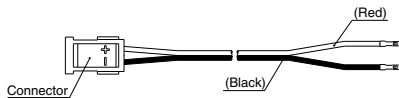

Connector assembly order no. (Can be used for the manifold with a specified layout)

Model	Part no.	Connector mounting position
SS5Y3-45S6A	SY3000-37-80A-3	Starting from the SI unit side: From unit 1 to unit 4
	SY3000-37-80A-4	Starting from the SI unit side: From unit 5 to unit 8
	SY3000-37-80A-6	Starting from the SI unit side: From unit 9 to unit 12
	SY3000-37-80A-7	Starting from the SI unit side: From unit 13 to unit 16
SS5Y5-45S6A	SY3000-37-80A-4	Starting from the SI unit side: From unit 1 to unit 4
	SY3000-37-80A-6	Starting from the SI unit side: From unit 5 to unit 8
	SY3000-37-80A-8	Starting from the SI unit side: From unit 9 to unit 12
	SY3000-37-80A-10	Starting from the SI unit side: From unit 13 to unit 16

Note 1) The above is for station addition or maintenance. When ordering a connector assembly separately, a number will not be printed on the connector.

Note 2) After inserting the connector assembly into the housing, be sure to confirm that the lead wire will not come off by lightly pulling the wire.

Furthermore, do not reuse the lead wire after it has been inserted and removed.

Note 3) Wiring is set longer than the actual wiring distance.

Stacking Type/DIN Rail Mounted/Individual Wiring: Common Manifold Option

■ **Blanking plate assembly**

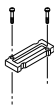

(The shape varies depending on the series.)

Series	Assembly part no.
SY3000	SX3000-75-1A(-Q)
SY5000	SX5000-76-5A(-Q)

* **Thread type**

Nil	Rc
F	G
N	NPT
T	NPTF

Caution

Mounting screw tightening torques

M2: 0.16 N·m
 M3: 0.8 N·m
 M4: 1.4 N·m

SJ

SY

SY

S0700

S0700

5 Port Solenoid Valve Base Mounted Manifold Stacking Type/DIN Rail Mounted/Plug-in

CE [Option]

SY3000/5000 Series

Type **45**

How to Order Manifold

Type 45F (D-sub connector, 25 pins)

SS5Y **3** - 45 **F** **D** - 05 **U** - **C4** - - - -

Series

3	SY3000
5	SY5000

Common specifications

NII	Positive common
N	Negative common

Connector mounting position

Symbol	Mounting position
U	U side
D	D side

Valve stations

Symbol	Stations	Note
02	2 stations	Single wiring spec. (Applicable up to 20 solenoid valves.)
:	:	
20	20 stations	

- * This also includes the number of blanking plate assemblies.
- * Two stations are necessary for the double, 3 position (Dual body type).

SUP/EXH block assembly mounting position

Symbol	Mounting position	Stations
U	U side	2 to 10 stations
D	D side	2 to 10 stations
B	(Both sides)	2 to 20 stations
M	Special specifications	

- * For special specifications, indicate separately by the manifold specification sheet.

A, B port size

One-touch fitting (Metric size)

Symbol	Port size	Applicable series
C4	One-touch fitting for ø4	SY3000
C6	One-touch fitting for ø6	
M	Mixed	
C4	One-touch fitting for ø4	SY5000
C6	One-touch fitting for ø6	
C8	One-touch fitting for ø8	
M	Mixed	

One-touch fitting (Inch size)

Symbol	Port size	Applicable series
N3	One-touch fitting for ø $\frac{3}{32}$ "	SY3000
N7	One-touch fitting for ø $\frac{1}{4}$ "	
M	Mixed	
N3	One-touch fitting for ø $\frac{3}{32}$ "	SY5000
N7	One-touch fitting for ø $\frac{1}{4}$ "	
N9	One-touch fitting for ø $\frac{9}{16}$ "	
M	Mixed	

- * In the case of mixed specifications (M), indicate separately on the manifold specification sheet.

Option

When a longer DIN rail is desired than the specified stations, specify the station number to be required. (20 stations at maximum)

CE-compliant

NII	—
Q	CE-compliant

- * Refer to pages 616 to 620 for external pilot specifications and built-in silencer.

How to Order Manifold Assembly (Example)

Example (Type 45F/D-sub connector (25 pin))

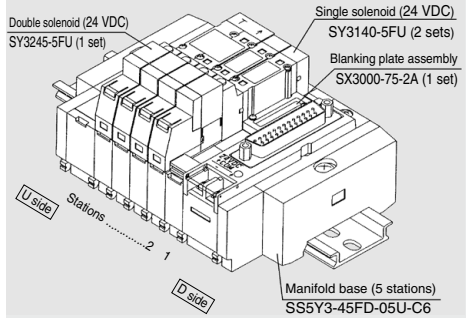

- SS5Y3-45FD-05U-C6 ... 1 set (Type 45F, D-sub connector 5-station manifold base part no.)
- * SX3000-75-2A 1 set (Blanking plate assembly part no.)
 - * SY3140-5FU 2 sets (Single solenoid part no.)
 - * SY3245-5FU 1 set (Double solenoid part no.)

The asterisk denotes the symbol for assembly. Prefix it to the part nos. of the solenoid valve, etc.

- * The valve arrangement is numbered as the 1st. station from D side regardless of the mounting position of connector box.
- * When ordering double solenoid valves/3 position (Dual body type), please keep in mind that they require two manifold stations.

How to Order Valve (Type 45F, 45P□, 45T, 45T1)

2 position single **SY 3 1 40-5 FU** - - - -

Double, 3 position **SY 3 2 45-5 FU** - - - -

Series

3	SY3000
5	SY5000

Type of actuation

2	2 position double
3	3 position closed center
4	3 position exhaust center
5	3 position pressure center

Rated voltage

5	24 VDC
6	12 VDC

Dual body type (Double, 3 position) Manual override

NII	Non-locking push type
D	Push-turn locking slotted type
E	Push-turn locking lever type

Made to Order

NII	—	CE-compliant
X90	Main valve fluororubber (Refer to page 624.)	Q CE-compliant

- * When ordering plug-in type solenoid valve as a single unit, gaskets are not included. Order them separately, if necessary. (Refer to page 592 for details.)
- * With light/surge voltage suppressor (Non-polar type)



How to Order Manifold

Type 45P (Flat ribbon cable)

SS5Y 3 - 45 P D - 05 U - C4 - - - -

Series

3	SY3000
5	SY5000

Common specifications

Nil	Positive common
N	Negative common

Connector poles

Symbol	Poles	Stations
Nil	26	2 to 20 stations
G	20	2 to 16 stations
H	10	2 to 8 stations

Connector mounting position

Symbol	Mounting position
U	U side
D	D side

• Voltage

Nil	24 VDC
12V	12 VDC

• A, B port size

Symbol	Port size	Applicable series
C4	One-touch fitting for ø4	SY3000
C6	One-touch fitting for ø6	
M	Mixed	SY5000
C4	One-touch fitting for ø4	
C6	One-touch fitting for ø6	
C8	One-touch fitting for ø8	
M	Mixed	

Symbol	Port size	Applicable series
N3	One-touch fitting for ø $\frac{3}{8}$ "	SY3000
N7	One-touch fitting for ø $\frac{1}{4}$ "	
M	Mixed	SY5000
N3	One-touch fitting for ø $\frac{3}{8}$ "	
N7	One-touch fitting for ø $\frac{1}{4}$ "	
N9	One-touch fitting for ø $\frac{5}{16}$ "	
M	Mixed	

* In the case of mixed specifications, indicate separately on the manifold specification sheet.

• SUP/EXH block assembly mounting position

Symbol	Mounting position	Stations
U	U side	2 to 10 stations
D	D side	2 to 10 stations
B	Both sides	2 to 20 stations
M	Special specifications	

Option
When a longer DIN rail is desired than the specified stations, specify the station number to be required. (20 stations at maximum)

CE-compliant

Nil	—
Q	CE-compliant

Valve stations (Blanking plate assemblies are included.)

26 pins (P) connector

Symbol	Stations	Note
02	2 stations	Single wiring spec. (Applicable up to 20 solenoid valves.)
:	:	
20	20 stations	

20 pins (PG) connector

Symbol	Stations	Note
02	2 stations	Single wiring spec. (Applicable up to 16 solenoid valves.)
:	:	
16	16 stations	

10 pins (PH) connector

Symbol	Stations	Note
02	2 stations	Single wiring spec. (Applicable up to 8 solenoid valves)
:	:	
08	8 stations	

* Two stations are necessary for the double, 3 position (Dual body type).

The SS5Y3/5-45T/1□ type plug-in terminal block manifold is to be discontinued as of December 2019. Therefore, we recommend considering the SY3000/5000/7000 plug-in connector connecting base terminal block box type manifold as a substitute. [Click here](#) for details.) However, keep in mind that there is no specification or mounting compatibility between the two products.

Type 45T (9 pins terminal block)

SS5Y 3 - 45T D - 05 U - C4 - - - -

Series

3	SY3000
5	SY5000

Terminal block mounting position

Symbol	Mounting position
U	U side
D	D side

Valve stations

Symbol	Stations	Note
02	2 stations	Single wiring spec. (Applicable up to 8 solenoid valves)
:	:	
08	8 stations	

* This also includes the number of blanking plate assemblies.
* Two stations are necessary for the double, 3 position (Dual body type).

SUP/EXH block assembly mounting position

Symbol	Mounting position	Stations
U	U side	2 to 8 stations
D	D side	2 to 8 stations
B	Both sides	2 to 8 stations
M	Special specifications	

* For special specifications, indicate separately by the manifold specification sheet.

Option

When a longer DIN rail is desired than the specified stations, specify the station number to be required. (20 stations at maximum)

CE-compliant

Nil	—
Q	CE-compliant

• A, B port size

Symbol	Port size	Applicable series
C4	One-touch fitting for ø4	SY3000
C6	One-touch fitting for ø6	
M	Mixed	SY5000
C4	One-touch fitting for ø4	
C6	One-touch fitting for ø6	
C8	One-touch fitting for ø8	
M	Mixed	

One-touch fitting (Inch size)

Symbol	Port size	Applicable series
N3	One-touch fitting for ø $\frac{3}{8}$ "	SY3000
N7	One-touch fitting for ø $\frac{1}{4}$ "	
M	Mixed	SY5000
N3	One-touch fitting for ø $\frac{3}{8}$ "	
N7	One-touch fitting for ø $\frac{1}{4}$ "	
N9	One-touch fitting for ø $\frac{5}{16}$ "	
M	Mixed	

* In the case of mixed specifications (M), indicate separately on the manifold specification sheet.

Type 45T1 (18 pins terminal block)

SS5Y 3 - 45T1 D - 15 B - C4 - - - -

Series

3	SY3000
5	SY5000

Terminal block mounting position

Symbol	Mounting position
U	U side
D	D side

Valve stations

Symbol	Stations	Note
02	2 stations	Single wiring spec. (Applicable up to 17 solenoid valves.)
:	:	
17	17 stations	

* This also includes the number of blanking plate assemblies.
* Two stations are necessary for the double, 3 position (Dual body type).

SUP/EXH block assembly mounting position

Symbol	Mounting position	Stations
U	U side	2 to 10 stations
D	D side	2 to 10 stations
B	Both sides	2 to 17 stations
M	Special specifications	

* For special specifications, indicate separately by the manifold specification sheet.

Option

When a longer DIN rail is desired than the specified stations, specify the station number to be required. (20 stations at maximum)

CE-compliant

Nil	—
Q	CE-compliant

• A, B port size

Symbol	Port size	Applicable series
C4	One-touch fitting for ø4	SY3000
C6	One-touch fitting for ø6	
M	Mixed	SY5000
C4	One-touch fitting for ø4	
C6	One-touch fitting for ø6	
C8	One-touch fitting for ø8	
M	Mixed	

One-touch fitting (Inch size)

Symbol	Port size	Applicable series
N3	One-touch fitting for ø $\frac{3}{8}$ "	SY3000
N7	One-touch fitting for ø $\frac{1}{4}$ "	
M	Mixed	SY5000
N3	One-touch fitting for ø $\frac{3}{8}$ "	
N7	One-touch fitting for ø $\frac{1}{4}$ "	
N9	One-touch fitting for ø $\frac{5}{16}$ "	
M	Mixed	

* In the case of mixed specifications (M), indicate separately on the manifold specification sheet.

Note) The terminal block (45T□) manifold has no common polarity. It can be used for both positive and negative common.

Manifold Specifications

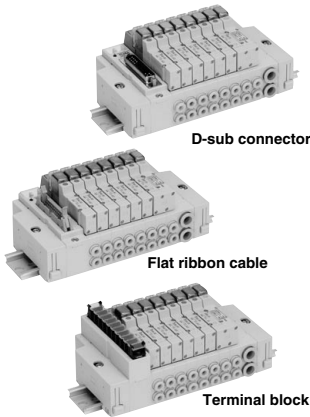

Model		D-sub connector Type 45F	Flat ribbon cable Type 45PI		Terminal block	
Manifold		Plug-in				
P (SUP)/R (EXH)		Common SUP, Common EXH				
Valve stations ^{Note 1, 2)}		2 to 20 stations	2 to 16 stations	2 to 8 stations	2 to 17 stations	
A, B port		Base				
Porting specifications		Direction				
Port size		Side				
P, R port	SY3000	C8 (One-touch fitting for ø8)				
	SY5000	C10 (One-touch fitting for ø10)				
	SY3000	C4 (One-touch fitting for ø4)/C6 (One-touch fitting for ø6)				
A, B port	SY3000	C4 (One-touch fitting for ø4)/C6 (One-touch fitting for ø6)/C8 (One-touch fitting for ø8)				
	SY5000	C4 (One-touch fitting for ø4)/C6 (One-touch fitting for ø6)/C8 (One-touch fitting for ø8)				
Applicable connector		D-sub connector Complies with MIL-C-24308 JIS-X-5101	Flat ribbon cable connector Socket: 20 pin MIL type with strain relief Conforming to MIL-C-8830	Flat ribbon cable connector Socket: 20 pin MIL type with strain relief Conforming to MIL-C-8830	Flat ribbon cable connector Socket: 10 pin MIL type with strain relief Conforming to MIL-C-8830	Terminal block (M3) 9 pins
Internal wiring		+COM (Type 45□), -COM (Type 45N□)			In common between +COM and -COM.	
Manifold base weight W (g)		SY3000	2 to 10 stations: W = 26n + 172 11 to 20 stations: W = 26n + 199			
n: Stations (D-sub connector)		SY5000	2 to 10 stations: W = 54n + 227 11 to 20 stations: W = 52n + 264			

Note 1) For more than 11 stations, supply pressure to P port on both sides and exhaust from R port on both sides.
 Note 2) There is a limit depending on the number of solenoids. Refer to "How to Order".

Flow Rate Characteristics

Model	Port size		Flow rate characteristics					
	1, 5, 3 (P, EA, EB)	4, 2 (A, B)	1 → 4/2 (P → A/B)			4/2 → 5/3 (A/B → EA/EB)		
			C (dm ³ /s-bar)	b	Cv	C (dm ³ /s-bar)	b	Cv
SS5Y3-45□	C8	C6	0.88	0.21	0.22	0.95	0.18	0.22
SS5Y5-45□	C10	C8	2.2	0.24	0.53	2.5	0.18	0.58

Note) The value is for manifold base with 5 stations and individually operated 2 position type.

SJ
SY
SY
S0700
S0700

Manifold Option

■ D-sub connector (25 pins)/Cable assembly

015
AXT100-DS25- 030
050

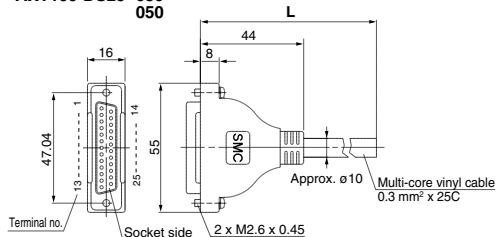

D-sub connector cable

Cable length (L)	Assembly part no.	Note
1.5 m	AXT100-DS25-015	Cable 25 core x 24 AWG
3 m	AXT100-DS25-030	
5 m	AXT100-DS25-050	

* When a commercially available connector is required, use a 25 pin female connector conforming to MIL-C24308.

Electric characteristics

Item	Characteristics
Conductor resistance Ω/km, 20°C	65 or less
Voltage limit V, 1 min, AC	1000
Insulation resistance MΩkm, 20°C	5 or more

Note) The min. bending radius of D-sub cable assembly is 20 mm.

D-sub connector cable assembly

Terminal numbers

Terminal no.	Lead wire color	Dot marking
1	Black	None
2	Brown	None
3	Red	None
4	Orange	None
5	Yellow	None
6	Pink	None
7	Blue	None
8	Purple	White
9	Gray	Black
10	White	Black
11	White	Red
12	Yellow	Red
13	Orange	Red
14	Yellow	Black
15	Pink	Black
16	Blue	White
17	Purple	None
18	Gray	None
19	Orange	Black
20	Red	White
21	Brown	White
22	Pink	Red
23	Gray	Red
24	Black	White
25	White	None

Connector manufacturers' example

- HIROSE ELECTRIC CO., LTD.
- Fujitsu Limited
- Japan Aviation Electronics Industry, Limited
- J.S.T. Mfg. Co., Ltd.

■ Flat Ribbon Cable Connector/Cable assembly

AXT100-FC □ $\frac{1}{3}$

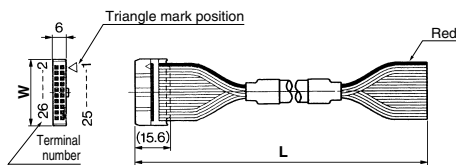

Flat Ribbon Cable Assembly

Cable length (L)	10 pins	20 pins	26 pins
1.5 m	AXT100-FC10-1	AXT100-FC20-1	AXT100-FC26-1
3 m	AXT100-FC10-2	AXT100-FC20-2	AXT100-FC26-2
5 m	AXT100-FC10-3	AXT100-FC20-3	AXT100-FC26-3
Connector width (W)	17.2	30	37.5

* For other commercial connectors, use a type with strain relief that conform to MIL-C-83503.

Connector manufacturers' example

- HIROSE ELECTRIC CO., LTD.
- 3M Japan Limited
- Fujitsu Limited
- Japan Aviation Electronics Industry, Limited
- J.S.T. Mfg. Co., Ltd.

■ Dimensions/DIN rail

VZ1000-11-1-□

Refer to L dimensions

* Fill in □ with an appropriate no. listed on the table of DIN rail dimensions shown below.

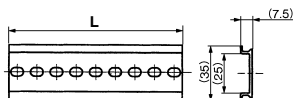

No.	0	1	2	3	4	5	6	7	8	9	10
L Dimension	98	110.5	123	135.5	148	160.5	173	185.5	198	210.5	223
No.	11	12	13	14	15	16	17	18	19	20	21
L Dimension	235.5	248	260.5	273	285.5	298	310.5	323	335.5	348	360.5
No.	22	23	24	25	26	27	28	29	30	31	32
L Dimension	373	385.5	398	410.5	423	435.5	448	460.5	473	485.5	498
No.	33	34	35	36	37	38	39	40	41	42	43
L Dimension	510.5	523	535.5	548	560.5	573	585.5	598	610.5	623	635.5
No.	44	45	46	47	48	49	50	51	52	53	54
L Dimension	648	660.5	673	685.5	698	710.5	723	735.5	748	760.5	773
No.	55	56	57	58	59	60	61	62	63	64	65
L Dimension	785.5	798	810.5	823	835.5	848	860.5	873	885.5	898	910.5
No.	66	67	68	69	70	71					
L Dimension	923	935.5	948	960.5	973	985.5					

* Refer to L1 dimension on pages starting with pages 574 to 591 for lengths that correspond to the number of manifold stations.

Manifold Internal Wiring

45(N)F/D-sub Connector

A D-sub connector used for electric wiring reduces labor during wiring operation. Connectors conforming to MIL are used for interchangeability.

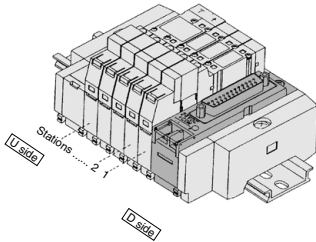

<For positive common (45F)>

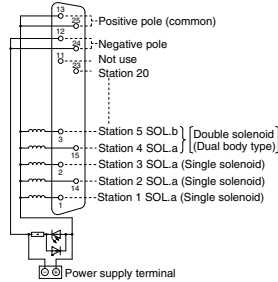

<For negative common (45NF)>

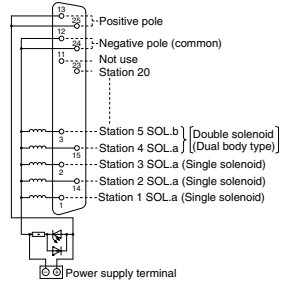

- The power source terminal is used for connecting to an external power source.
- The maximum number of stations that can be accommodated is 20 manifold stations, with up to 20 solenoids. (For more stations, please contact SMC.)
- Regardless of the connector mounting position, stations are to be counted from D side as the 1st one.

Type 45(N)P/Flat Ribbon Cable (26 pins)

A flat ribbon cable connector used for electric wiring reduces labor during wiring operation. Connectors conforming to MIL are used for interchangeability.

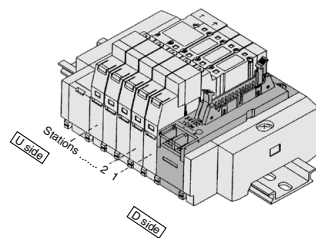

<For positive common (45P)>

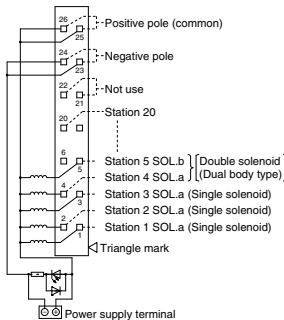

<For negative common (45NP)>

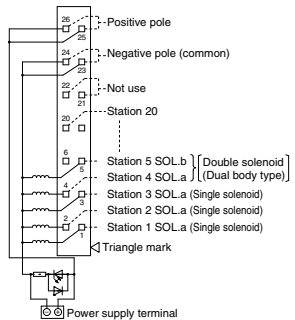

- The power source terminal is used for connecting to an external power source.
- The maximum number of stations that can be accommodated is 20 manifold stations, with up to 20 solenoids. (For more stations, please contact SMC.)
- Regardless of the connector mounting position, stations are to be counted from D side as the 1st one.

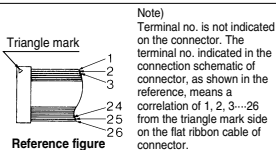

Manifold Internal Wiring

Type 45(N)PG/Flat Ribbon Cable (20 pins)

A flat ribbon cable connector used for electric wiring reduces labor during wiring operation. Connectors conforming to MIL are used for interchangeability.

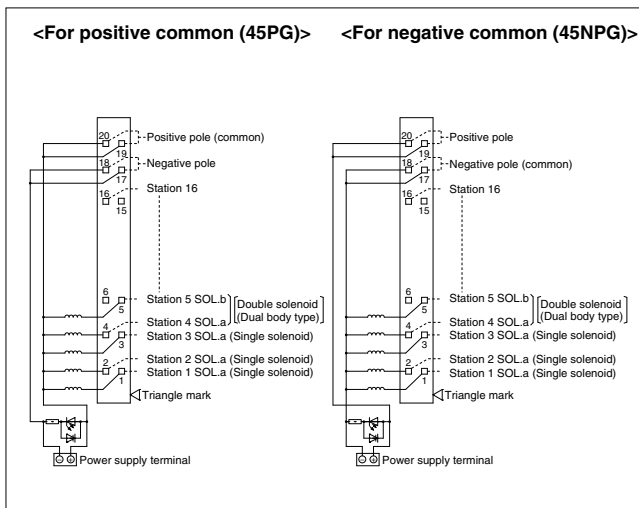
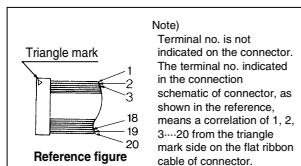
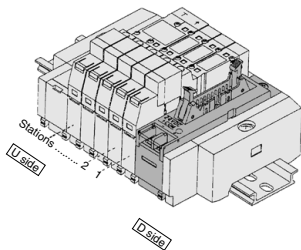

- The power source terminal is used for connecting to an external power source.
- The maximum number of stations that can be accommodated is 16 manifold stations, with up to 16 solenoids. (For more stations, please contact SMC.)
- Regardless of the connector mounting position, stations are to be counted from D side as the 1st one.

Type 45(N)PH/Flat Ribbon Cable (10 pins)

A flat ribbon cable connector used for electric wiring reduces labor during wiring operation. Connectors conforming to MIL are used for interchangeability.

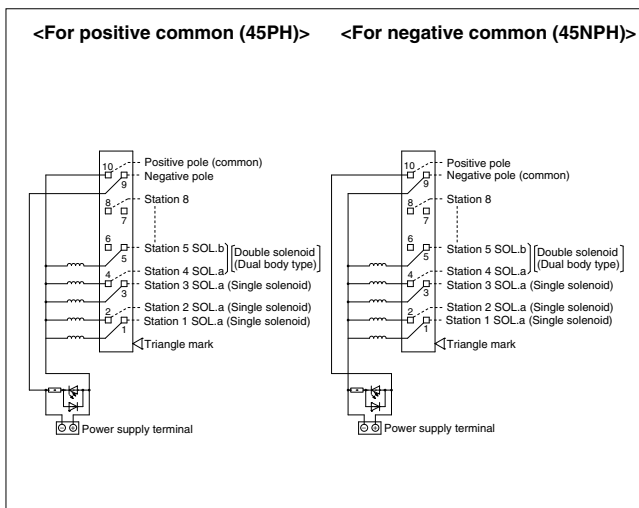
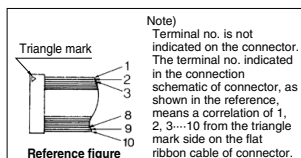
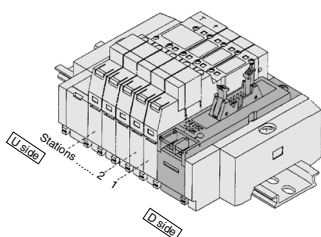

- The power source terminal is used for connecting to an external power source.
- The maximum number of stations that can be accommodated is 8 manifold stations, with up to 8 solenoids. (For more stations, please contact SMC.)
- Regardless of the connector mounting position, stations are to be counted from D side as the 1st one.

Manifold Internal Wiring

Type 45T/Terminal Block

A terminal block type permits direct cable connection without treatment of lead wires.

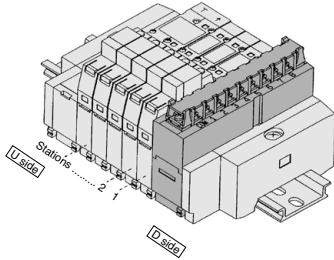

(45T)

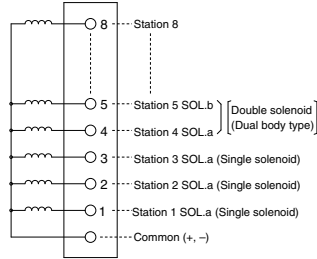

- The maximum number of stations that can be accommodated is 8 manifold stations, with up to 8 solenoids. (For more stations, please contact SMC.)
- Regardless of the connector mounting position, stations are to be counted from D side as the 1st one.
- There is no polarity in the COM wiring. Supply positive power for +COM spec. and negative power for -COM spec.

Type 45T1/Terminal Block

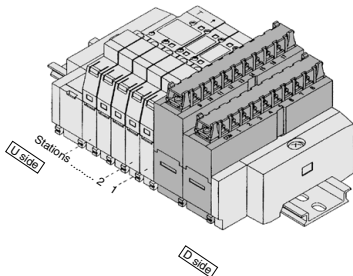

(45T1)

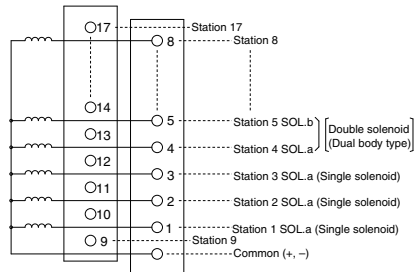

- The maximum number of stations that can be accommodated is 17 manifold stations, with up to 17 solenoids. (For more stations, please contact SMC.)
- Regardless of the connector mounting position, stations are to be counted from D side as the 1st one.
- There is no polarity in the COM wiring. Supply positive power for +COM spec. and negative power for -COM spec.

SJ
SY
SY
S0700
S0700

How to Connect SS5Y□-45□ (Plug-in)

Power terminal is equipped with plug-in manifold of the SY series as standard. Power terminal enables the power supply to valve from either of manifold or controller side. The wiring examples should be used for reference when wiring is performed.

1. Wiring example when using manifold power supply terminals

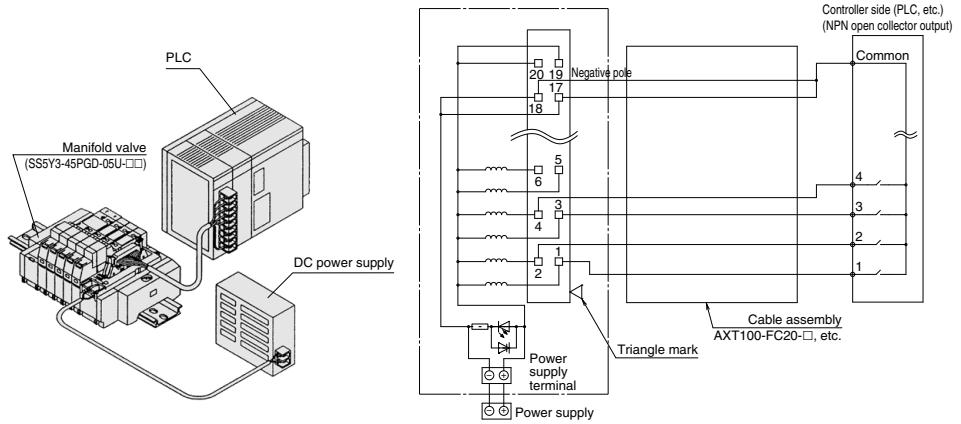

2. Wiring example when not using manifold power supply terminals (Power is supplied to the controller side or along the wiring, etc.)

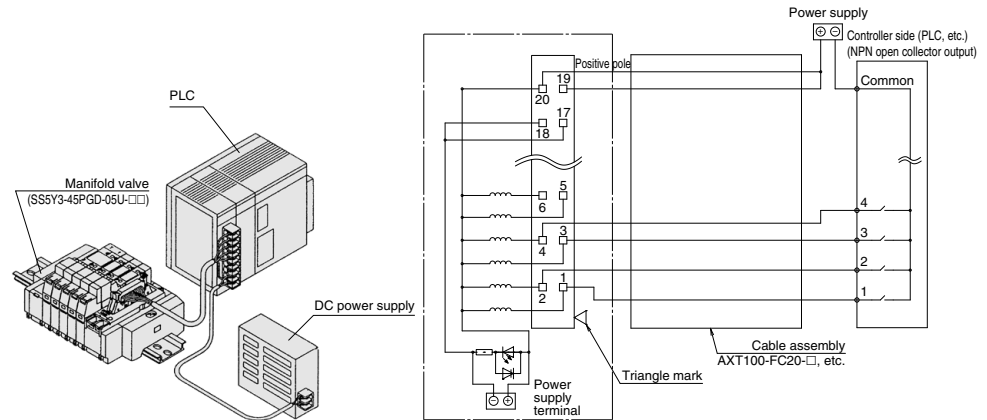

⚠ Caution

- Single wire, COM position, etc. of PLC are different from each manufacturer. When connecting with PLC, read the specifications carefully and understand the electrical circuit. Poor wiring could cause damage to PLC, power source, etc. as well as manifold and valve.

SJ
SY
SY
S0700
S0700

SY3000: D-sub Connector/Plug-in

**SS5Y3-45FU- Stations D- C4, N3
C6, N7**

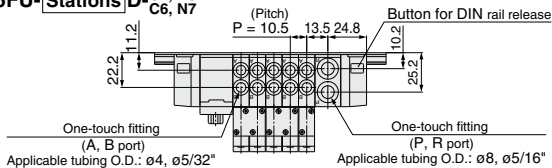

Note) The L1 to L4 dimensions of **SS5Y3-45FU- Stations U- C4, N3
C6, N7** are identical to those of **SS5Y3-45FU- Stations D- C4, N3
C6, N7**.

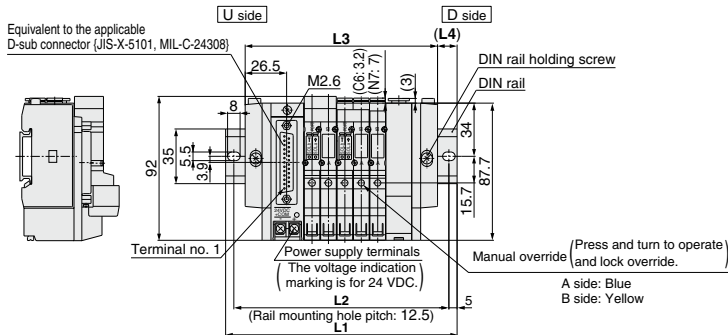

A side: Blue
B side: Yellow

(Station n) --- (Station 1)
(Light/surge voltage suppressor)

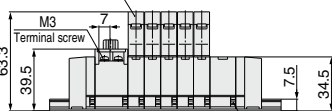

Stations n	2 stations	3	4	5	6	7	8	9	10 stations
L1	123	135.5	148	148	160.5	173	185.5	198	210.5
L2	112.5	125	137.5	137.5	150	162.5	175	187.5	200
L3	91.5	102	112.5	123	133.5	144	154.5	165	175.5
L4	15.5	16.5	17.5	12.5	13.5	14.5	15.5	16.5	17.5

**SS5Y3-45FU- Stations B- C4, N3
C6, N7**

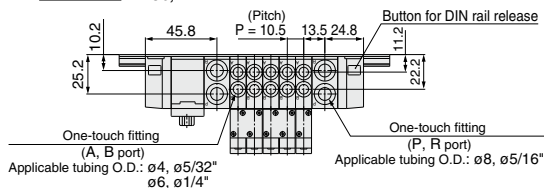

Equivalent to the applicable
D-sub connector (JIS-X-5101, MIL-C-24308)

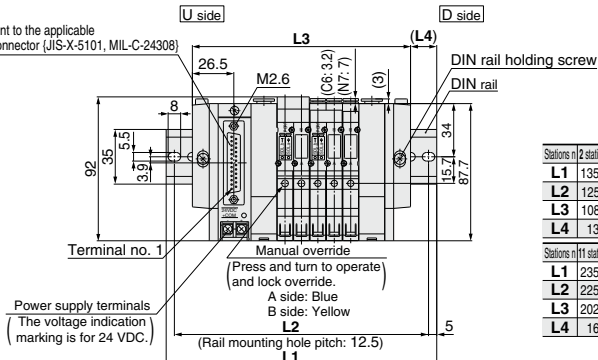

Stations n	2 stations	3	4	5	6	7	8	9	10 stations
L1	135.5	148	160.5	173	185.5	185.5	198	210.5	223
L2	125	137.5	150	162.5	175	175	187.5	200	212.5
L3	108	118.5	129	139.5	150	160.5	171	181.5	192
L4	13.5	14.5	15.5	16.5	17.5	12.5	13.5	14.5	15.5

Stations n	11 stations	12	13	14	15	16	17	18	19	20 stations
L1	235.5	248	248	260.5	273	285.5	298	310.5	310.5	323
L2	225	237.5	237.5	250	262.5	275	287.5	300	300	312.5
L3	202.5	213	223.5	234	244.5	255	265.5	276	286.5	297
L4	16.5	17.5	12	13	14	15	16	17	12	13

SY3000: D-sub Connector/Plug-in

**SS5Y3-45FD-Stations U-C₄, N₃
C₆, N₇**

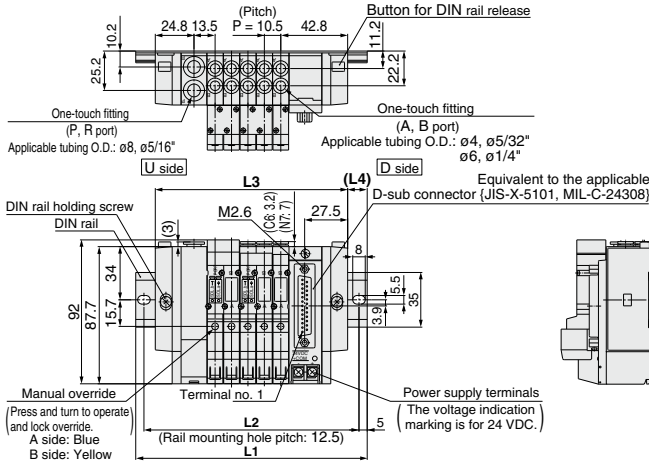

(Note) The L1 to L4 dimensions of **SS5Y3-45FD-Stations D-C₄, N₃** are identical to those of **SS5Y3-45FD-Stations U-C₄, N₃**.

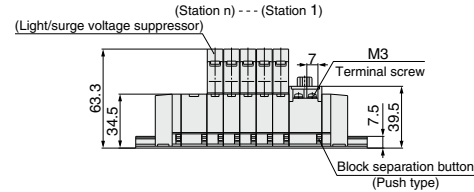

Stations n	2 stations	3	4	5	6	7	8	9	10 stations
L1	123	135.5	148	148	160.5	173	185.5	198	210.5
L2	112.5	125	137.5	137.5	150	162.5	175	187.5	200
L3	91.5	102	112.5	123	133.5	144	154.5	165	175.5
L4	15.5	16.5	17.5	12.5	13.5	14.5	15.5	16.5	17.5

**SS5Y3-45FD-Stations B-C₄, N₃
C₆, N₇**

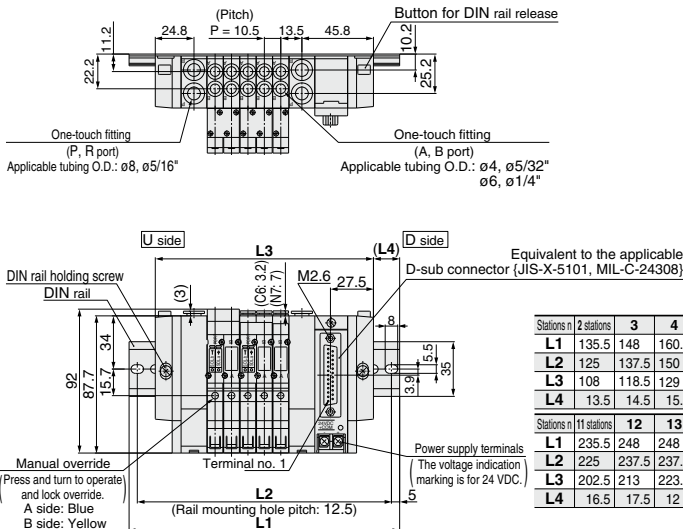

Stations n	2 stations	3	4	5	6	7	8	9	10 stations
L1	135.5	148	160.5	173	185.5	185.5	198	210.5	223
L2	125	137.5	150	162.5	175	175	187.5	200	212.5
L3	108	118.5	129	139.5	150	160.5	171	181.5	192
L4	13.5	14.5	15.5	16.5	17.5	12.5	13.5	14.5	15.5

Stations n	11 stations	12	13	14	15	16	17	18	19	20 stations
L1	235.5	248	248	260.5	273	285.5	298	310.5	310.5	323
L2	225	237.5	237.5	250	262.5	275	287.5	300	300	312.5
L3	202.5	213	223.5	234	244.5	255	265.5	276	286.5	297
L4	16.5	17.5	12	13	14	15	16	17	12	13

SJ
SY
SY
S0700
S0700

SY5000: D-sub Connector/Plug-in

SS5Y5-45FU-**Stations D** C4, N3 C6, N7 C8, N9

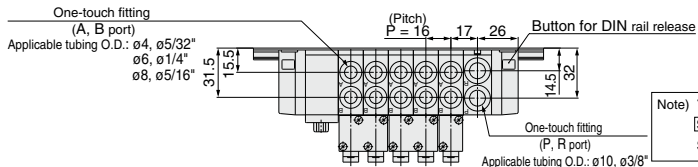

Note) The L1 to L4 dimensions of **SS5Y5-45FU-
C4, N3
Stations U-C6, N7** are identical to those of
**SS5Y5-45FU-
C6, N7
Stations D-C8, N9**

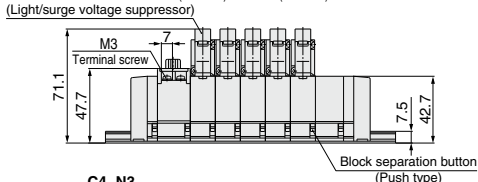
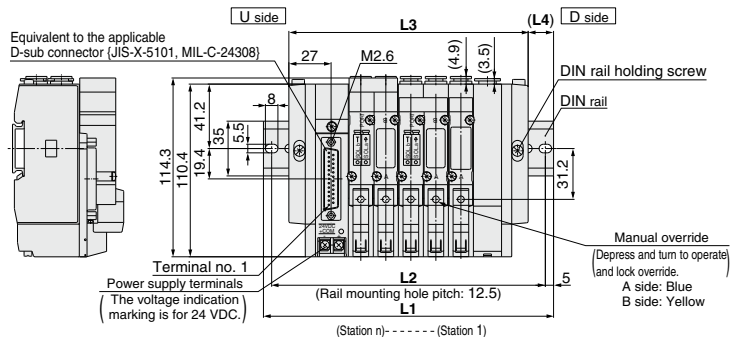

Stations n	2 stations	3	4	5	6	7	8	9	10 stations
L1	135.5	148	160.5	185.5	198	210.5	235.5	248	260.5
L2	125	137.5	150	175	187.5	200	225	237.5	250
L3	105	121	137	153	169	185	201	217	233
L4	15	13.5	11.5	16	14.5	12.5	17	15.5	13.5

SS5Y5-45FU-**Stations B** C4, N3 C6, N7 C8, N9

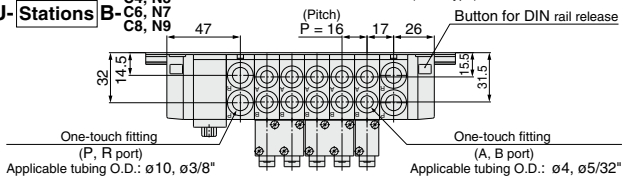

Equivalent to the applicable
D-sub connector (JIS-X-5101, MIL-C-24308)

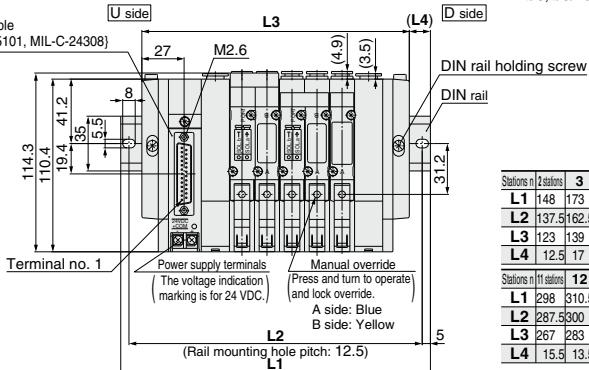

Stations n	2 stations	3	4	5	6	7	8	9	10 stations
L1	148	173	185.5	198	210.5	235.5	248	260.5	285.5
L2	137.5	162.5	175	187.5	200	225	237.5	250	275
L3	123	139	155	171	187	203	219	235	251
L4	12.5	17	15	13.5	11.5	16	14.5	12.5	17

Stations n	11 stations	12	13	14	15	16	17	18	19	20 stations
L1	298	310.5	323	348	360.5	373	398	410.5	423	435.5
L2	287.5	300	312.5	337.5	350	362.5	387.5	400	412.5	425
L3	267	283	299	315	331	347	363	379	395	411
L4	15.5	13.5	12	16.5	14.5	13	17.5	15.5	14	12

SY5000: D-sub Connector/Plug-in

SS5Y5-45FD- Stations U- C4, N3
C6, N7
C8, N9

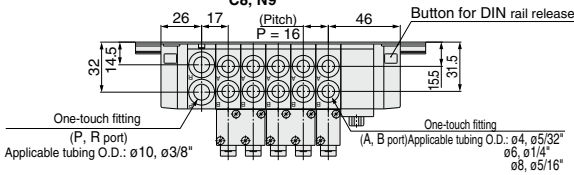

Note) The L1 to L4 dimensions of **SS5Y5-45FD- Stations U-** C4, N3 C6, N7 C8, N9 are identical to those of **SS5Y5-45FD- Stations U-** C4, N3 C6, N7 C8, N9

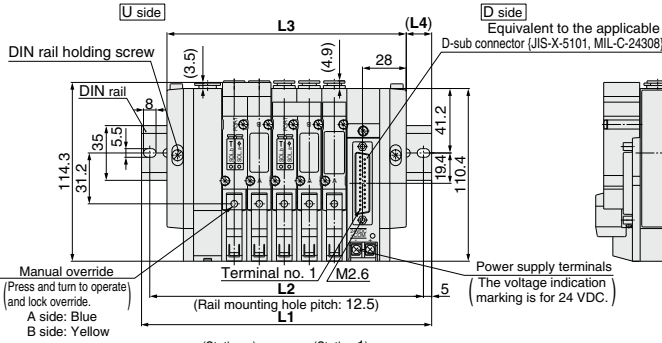

Stations n	2 stations	3	4	5	6	7	8	9	10 stations
L1	135.5	148	160.5	185.5	198	210.5	235.5	248	260.5
L2	125	137.5	150	175	187.5	200	225	237.5	250
L3	105	121	137	153	169	185	201	217	233
L4	15	13.5	11.5	16	14.5	12.5	17	15.5	13.5

SS5Y5-45FD- Stations B- C4, N3
C6, N7
C8, N9

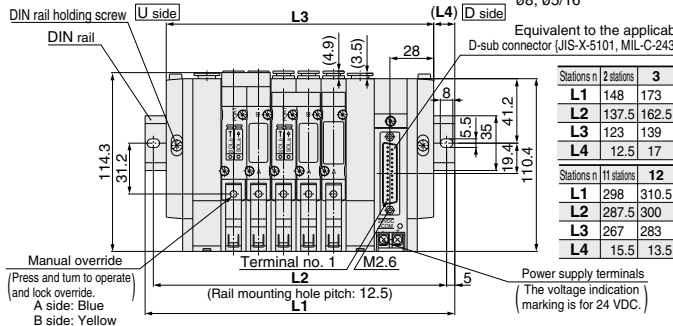
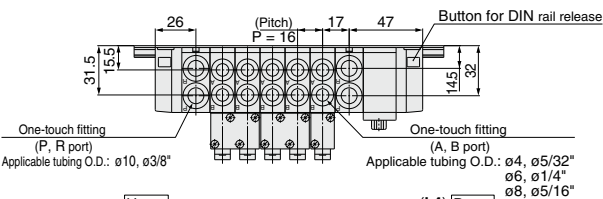

Stations n	2 stations	3	4	5	6	7	8	9	10 stations
L1	148	173	185.5	198	210.5	235.5	248	260.5	285.5
L2	137.5	162.5	175	187.5	200	225	237.5	250	275
L3	123	139	155	171	187	203	219	235	251
L4	12.5	17	15	13.5	11.5	16	14.5	12.5	17

Stations n	11 stations	12	13	14	15	16	17	18	19	20 stations
L1	298	310.5	323	348	360.5	373	398	410.5	423	435.5
L2	287.5	300	312.5	337.5	350	362.5	387.5	400	412.5	425
L3	267	283	299	315	331	347	363	379	395	411
L4	15.5	13.5	12	16.5	14.5	13	17.5	15.5	14	12

SJ
SY
SY
S0700
S0700

SY3000: Flat Ribbon Cable/Plug-in

SS5Y3-45PU - Stations D-C₄, N₃ C₆, N₇ (26 pins)

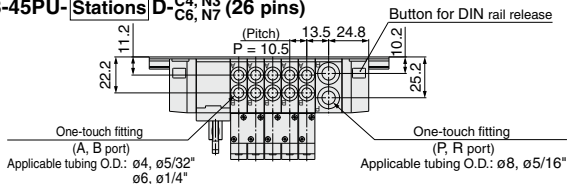

Note) The L1 to L4 dimensions of **SS5Y3-45PU** Stations U-C₄, N₃ C₆, N₇ are identical to those of **SS5Y3-45PIU** Stations D-C₄, N₃ C₆, N₇.

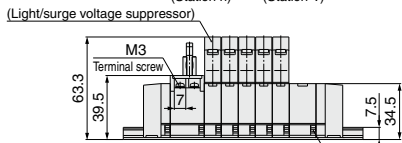
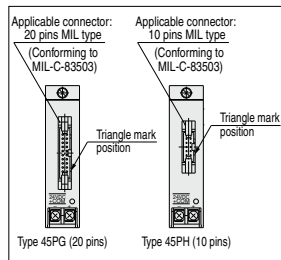
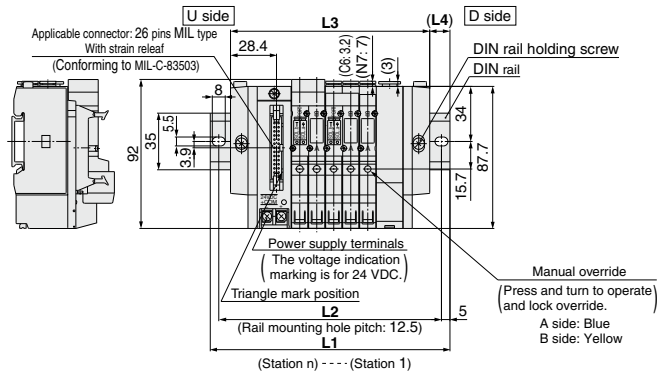

Stations n	2 stations	3	4	5	6	7	8	9	10 stations
L1	123	135.5	148	148	160.5	173	185.5	198	210.5
L2	112.5	125	137.5	137.5	150	162.5	175	187.5	200
L3	91.5	102	112.5	123	133.5	144	154.5	165	175.5
L4	15.5	16.5	17.5	12.5	13.5	14.5	15.5	16.5	17.5

SS5Y3-45PU - Stations B-C₄, N₃ C₆, N₇ (26 pins)

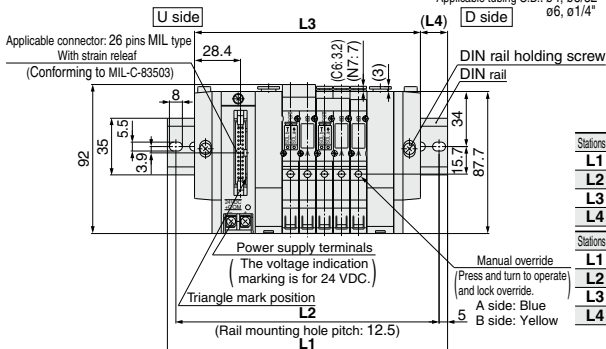
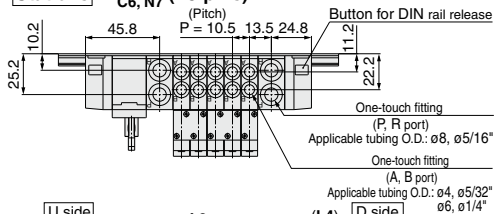

Stations n	2 stations	3	4	5	6	7	8	9	10 stations
L1	135.5	148	160.5	173	185.5	185.5	198	210.5	223
L2	125	137.5	150	162.5	175	175	187.5	200	212.5
L3	108	118.5	129	139.5	150	160.5	171	181.5	192
L4	13.5	14.5	15.5	16.5	17.5	12.5	13.5	14.5	15.5

Stations n	11 stations	12	13	14	15	16	17	18	19	20 stations
L1	235.5	248	248	260.5	273	285.5	298	310.5	310.5	323
L2	225	237.5	237.5	250	262.5	275	287.5	300	300	312.5
L3	202.5	213	223.5	234	244.5	255	265.5	276	286.5	297
L4	16.5	17.5	12	13	14	15	16	17	12	13

SY3000: Flat Ribbon Cable/Plug-in

SS5Y3-45PD- Stations U, C₄, N₃ (26 pins)

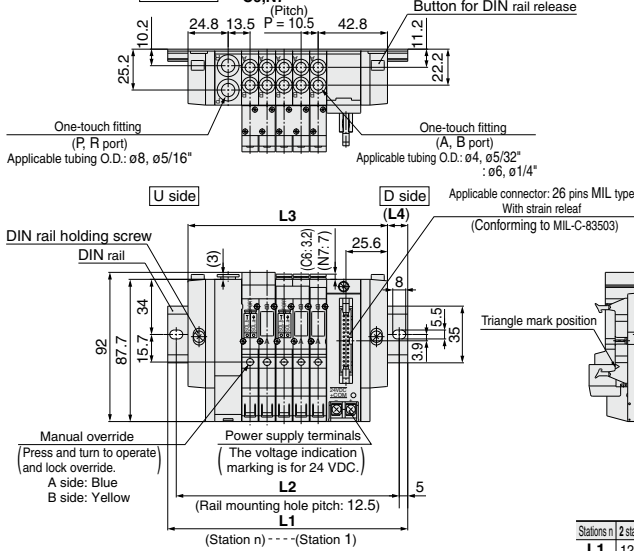

(Note) The L1 to L4 dimensions of **SS5Y3-45P□D- Stations U, C₄, N₃** are identical to those of **SS5Y3-45P□D- Stations U, C₄, N₃**.

Stations n	2 stations	3	4	5	6	7	8	9	10 stations
L1	123	135.5	148	148	160.5	173	185.5	198	210.5
L2	112.5	125	137.5	137.5	150	162.5	175	187.5	200
L3	91.5	102	112.5	123	133.5	144	154.5	165	175.5
L4	15.5	16.5	17.5	12.5	13.5	14.5	15.5	16.5	17.5

SS5Y3-45PD- Stations B, C₄, N₃ (26 pins)

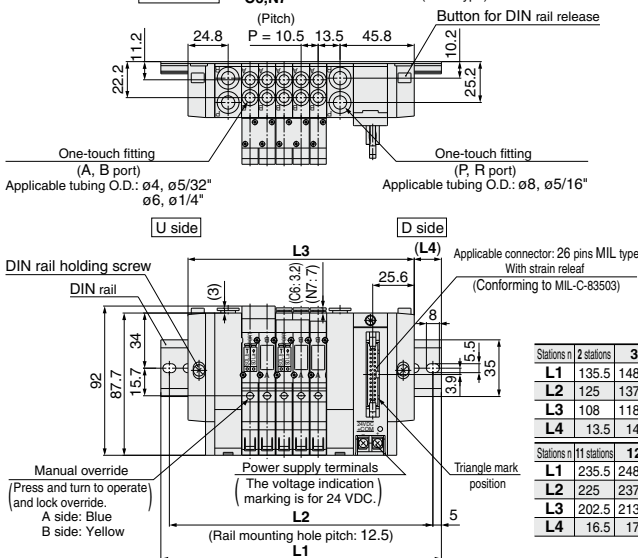

Stations n	2 stations	3	4	5	6	7	8	9	10 stations
L1	135.5	148	160.5	173	185.5	185.5	198	210.5	223
L2	125	137.5	150	162.5	175	175	187.5	200	212.5
L3	108	118.5	129	139.5	150	160.5	171	181.5	192
L4	13.5	14.5	15.5	16.5	17.5	12.5	13.5	14.5	15.5

Stations n	11 stations	12	13	14	15	16	17	18	19	20 stations
L1	235.5	248	248	260.5	273	285.5	298	310.5	310.5	323
L2	225	237.5	237.5	250	262.5	275	287.5	300	300	312.5
L3	202.5	213	223.5	234	244.5	255	265.5	276	286.5	297
L4	16.5	17.5	12	13	14	15	16	17	12	13

SJ
SY
SY
S0700
S0700

SY5000: Flat Ribbon Cable/Plug-in

SS5Y5-45PU - Stations D-^{C4, N3}_{C6, N7} (26 pins)

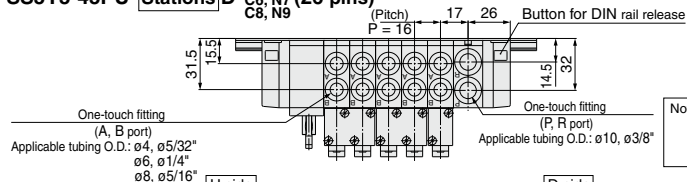

Note) The L1 to L4 dimensions of **SS5Y5-45P□U- Stations U-^{C4, N3}_{C6, N7}** are identical to those of **SS5Y5-45P□U- Stations D-^{C4, N3}_{C6, N7}**

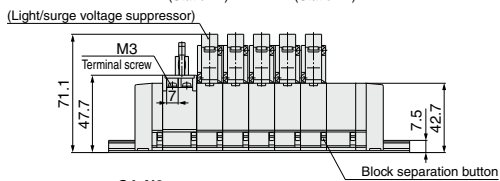
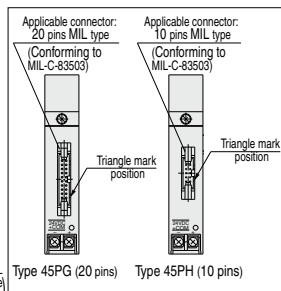
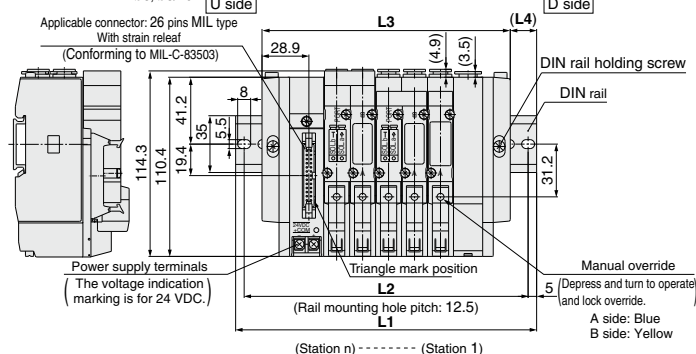

Stations n	2 stations	3	4	5	6	7	8	9	10 stations
L1	135.5	148	160.5	185.5	198	210.5	235.5	248	260.5
L2	125	137.5	150	175	187.5	200	225	237.5	250
L3	105	121	137	153	169	185	201	217	233
L4	15	13.5	11.5	16	14.5	12.5	17	15.5	13.5

SS5Y5-45PU - Stations B-^{C4, N3}_{C6, N7} (26 pins)

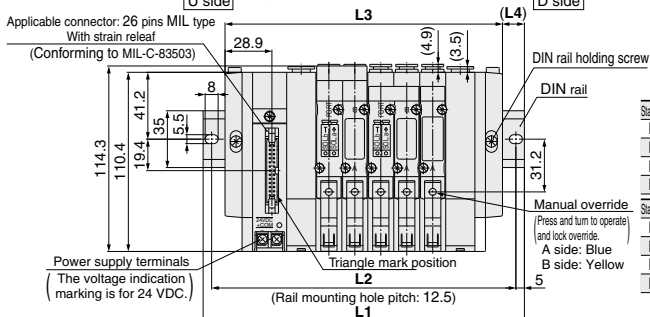
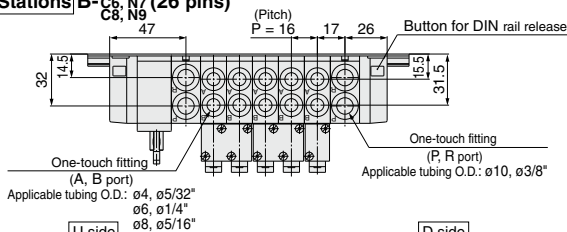

Stations n	2 stations	3	4	5	6	7	8	9	10 stations
L1	148	173	185.5	198	210.5	235.5	248	260.5	285.5
L2	137.5	162.5	175	187.5	200	225	237.5	250	275
L3	123	139	155	171	187	203	219	235	251
L4	12.5	17	15	13.5	11.5	16	14.5	12.5	17

Stations n	11 stations	12	13	14	15	16	17	18	19	20 stations
L1	298	310.5	323	348	360.5	373	398	410.5	423	435.5
L2	287.5	300	312.5	337.5	350	362.5	387.5	400	412.5	425
L3	267	283	299	315	331	347	363	379	395	411
L4	15.5	13.5	12	16.5	14.5	13	17.5	15.5	14	12

SY5000: Flat Ribbon Cable/Plug-in

SS5Y5-45PD- [Stations] U-^{C4, N3}_{C6, N7} (26 pins)
^{C4, N3}_{C8, N9}

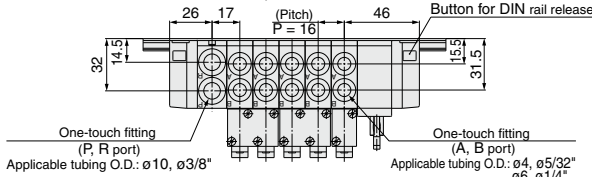

Note) The L1 to L4 dimensions of SS5Y5-45PD-^{C4, N3}_{C6, N7} [Stations] D- are identical to those of SS5Y3-45PD- [Stations] U-^{C4, N3}_{C6, N7}^{C4, N3}_{C8, N9}

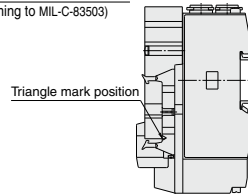
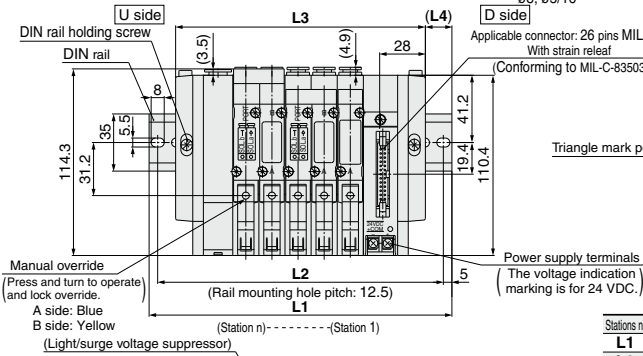

Stations n	2 stations	3	4	5	6	7	8	9	10 stations
L1	135.5	148	160.5	185.5	198	210.5	235.5	248	260.5
L2	125	137.5	150	175	187.5	200	225	237.5	250
L3	105	121	137	153	169	185	201	217	233
L4	15	13.5	11.5	16	14.5	12.5	17	15.5	13.5

SS5Y5-45PD- [Stations] B-^{C4, N3}_{C6, N7} (26 pins)
^{C4, N3}_{C8, N9}

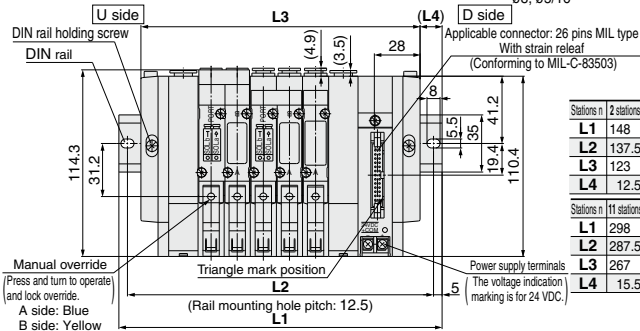
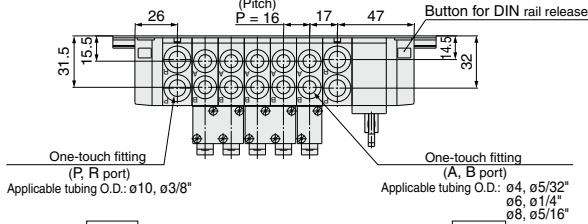

Stations n	2 stations	3	4	5	6	7	8	9	10 stations
L1	148	173	185.5	198	210.5	235.5	248	260.5	285.5
L2	137.5	162.5	175	187.5	200	225	237.5	250	275
L3	123	139	155	171	187	203	219	235	251
L4	12.5	17	15	13.5	11.5	16	14.5	12.5	17

Stations n	11 stations	12	13	14	15	16	17	18	19	20 stations
L1	298	310.5	323	348	360.5	373	398	410.5	423	435.5
L2	287.5	300	312.5	337.5	350	362.5	387.5	400	412.5	425
L3	267	283	299	315	331	347	363	379	395	411
L4	15.5	13.5	12	16.5	14.5	13	17.5	15.5	14	12

SY3000: 9 Pins Terminal Block/Plug-in

SS5Y3-45TU-Stations D-C₄, N₃ C₆, N₇ (9 pins)

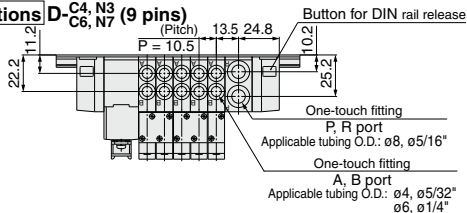

Note) The L1 to L4 dimensions of **SS5Y3-45TU-**
[Stations]U-C₄, N₃, SS5Y3-45TD-[Stations]U-C₄, N₃, SS5Y3-45TD-[Stations]D-C₄, N₃ are identical those of SS5Y3-45TU-[Stations]D-C₄, N₃, C₆, N₇.

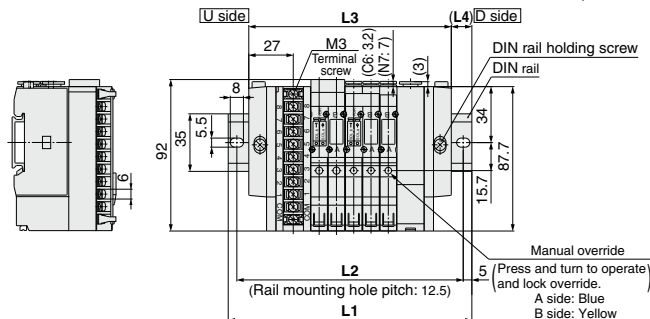

(Light/surge voltage suppressor) (Station n)----(Station 1)



Stations n	2 stations	3	4	5	6	7	8 stations
L1	123	135.5	148	148	160.5	173	185.5
L2	112.5	125	137.5	137.5	150	162.5	175
L3	91.5	102	112.5	123	133.5	144	154.5
L4	15.5	16.5	17.5	12.5	13.5	14.5	15.5

SS5Y3-45TU-Stations B-C₄, N₃ C₆, N₇ (9 pins)

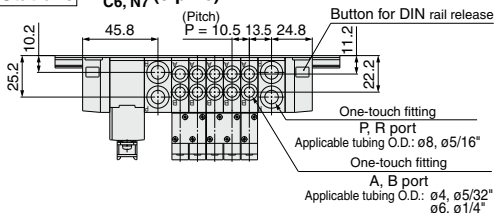

Note) The L1 to L4 dimensions of **SS5Y3-45TD-**
[Stations]B-C₄, N₃ are identical to those of SS5Y3-45TU-[Stations]B-C₄, N₃, C₆, N₇.

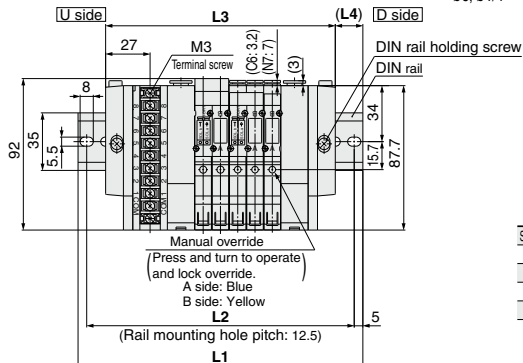

Stations n	2 stations	3	4	5	6	7	8 stations
L1	135.5	148	160.5	173	185.5	185.5	198
L2	125	137.5	150	162.5	175	175	187.5
L3	108	118.5	129	139.5	150	160.5	171
L4	13.5	14.5	15.5	16.5	17.5	12.5	13.5

SY5000: 9 Pins Terminal Block/Plug-in

**SS5Y5-45TU- Stations D- C4, N3
C6, N7 (9 pins)
C8, N9**

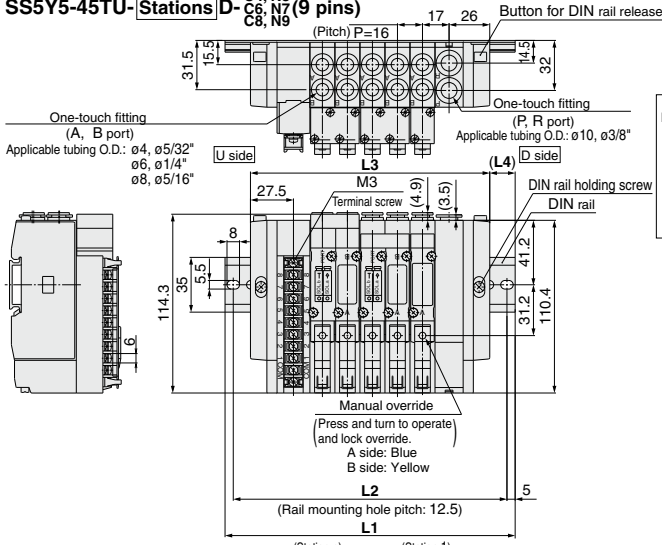

Note) The L1 to L4 dimensions of SS5Y5-45TU-

Stations U- C4, N3
C6, N7 SS5Y5-45TD- Stations U- C4, N3
C6, N9

SS5Y5-45TD- Stations D- C4, N3
C6, N7 are identical those
of SS5Y5-45TU- Stations D- C4, N3
C6, N9

Stations n/2 stations	3	4	5	6	7	8 stations	
L1	135.5	148	160.5	185.5	198	210.5	235.5
L2	125	137.5	150	175	187.5	200	225
L3	105	121	137	153	169	185	201
L4	15	13.5	11.5	16	14.5	12.5	17

**SS5Y5-45TU- Stations B- C4, N3
C6, N7 (9 pins)
C8, N9**

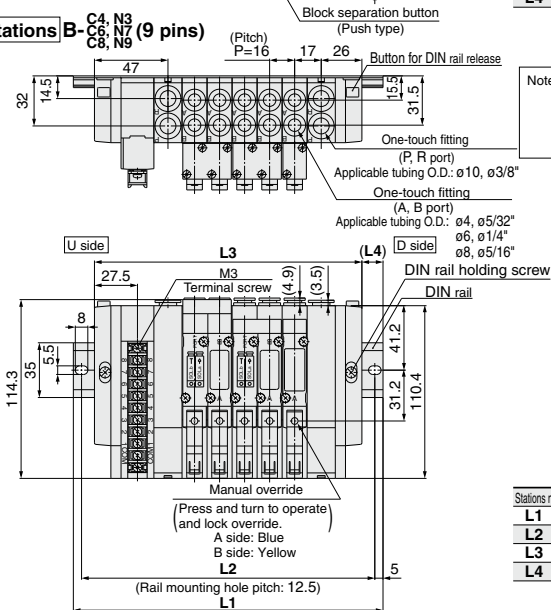

Note) The L1 to L4 dimensions of SS5Y5-45TD-

Stations B- C4, N3
C6, N7 are identical to those of

SS5Y5-45TU- Stations B- C4, N3
C6, N7

Stations n/2 stations	3	4	5	6	7	8 stations	
L1	148	173	185.5	198	210.5	235.5	248
L2	137.5	162.5	175	187.5	200	225	237.5
L3	123	139	155	171	187	203	219
L4	12.5	17	15	13.5	11.5	16	14.5

SY3000: 18 Pins Terminal Block/Plug-in

SS5Y3-45T1U-(Stations) D-C₄, N₃ C₆, N₇ (18 pins)

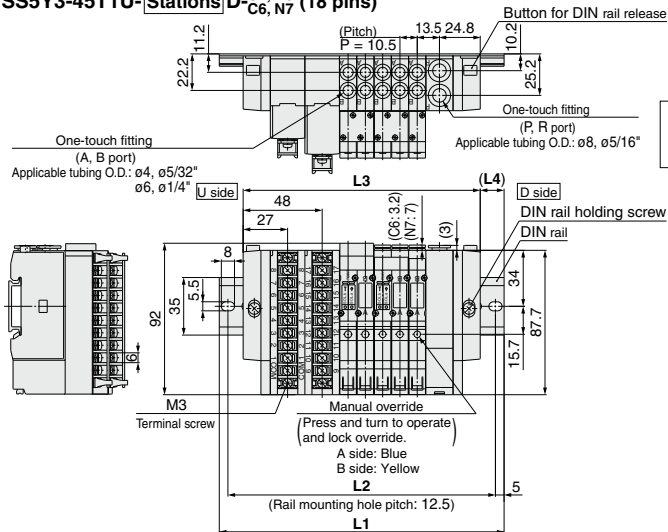

Note) The L1 to L4 dimensions of **SS5Y3-45T1U-(Stations) U-C₄, N₃ C₆, N₇** are identical to those of **SS5Y3-45T1U-(Stations) D-C₄, N₃ C₆, N₇**.

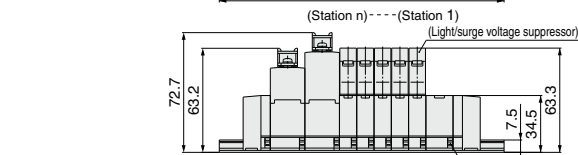

Stations n	2 stations	3	4	5	6	7	8	9	10 stations
L1	148	148	160.5	173	185.5	198	210.5	210.5	223
L2	137.5	137.5	150	162.5	175	187.5	200	200	212.5
L3	112.5	123	133.5	144	154.5	165	175.5	186	196.5
L4	17.5	12.5	13.5	14.5	15.5	16.5	17.5	12	13

SS5Y3-45T1U-(Stations) B-C₄, N₃ C₆, N₇ (18 pins)

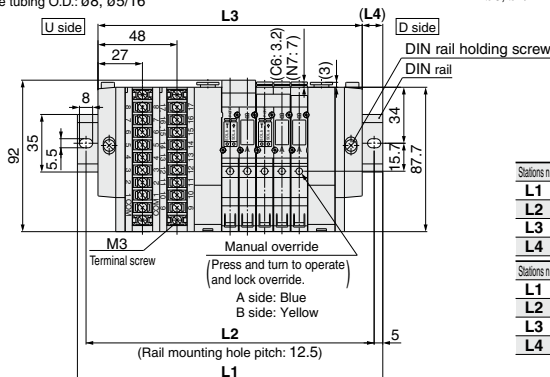
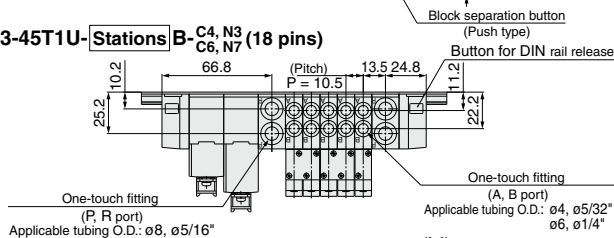

Stations n	2 stations	3	4	5	6	7	8	9 stations
L1	160.5	173	185.5	185.5	198	210.5	223	235.5
L2	150	162.5	175	175	187.5	200	212.5	225
L3	129	139.5	150	160.5	171	181.5	192	202.5
L4	15.5	16.5	17.5	12.5	13.5	14.5	15.5	16.5

Stations n	10 stations	11	12	13	14	15	16	17 stations
L1	248	248	260.5	273	285.5	298	310.5	310.5
L2	237.5	237.5	250	262.5	275	287.5	300	300
L3	213	223.5	234	244.5	255	265.5	276	286.5
L4	17.5	12	13	14	15	16	17	12

SY3000: 9 Pins Terminal Block/Plug-in

SS5Y3-45T1D- Stations U- C4, N3 / C6, N7 (18 pins)

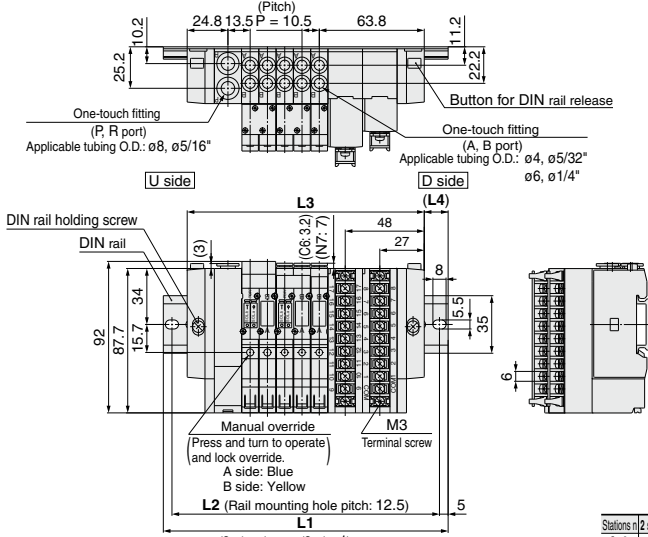

Note) The L1 to L4 dimensions of **SS5Y3-45T1D- Stations D- C4, N3 / C6, N7** are identical to those of **SS5Y3-45T1D- Stations U- C4, N3 / C6, N7**.

Stations n	2 stations	3	4	5	6	7	8	9	10 stations
L1	148	148	160.5	173	185.5	198	210.5	210.5	223
L2	137.5	137.5	150	162.5	175	187.5	200	200	212.5
L3	112.5	123	133.5	144	154.5	165	175.5	186	196.5
L4	17.5	12.5	13.5	14.5	15.5	16.5	17.5	12	13

SS5Y3-45T1D- Stations B- C4, N3 / C6, N7 (18 pins)

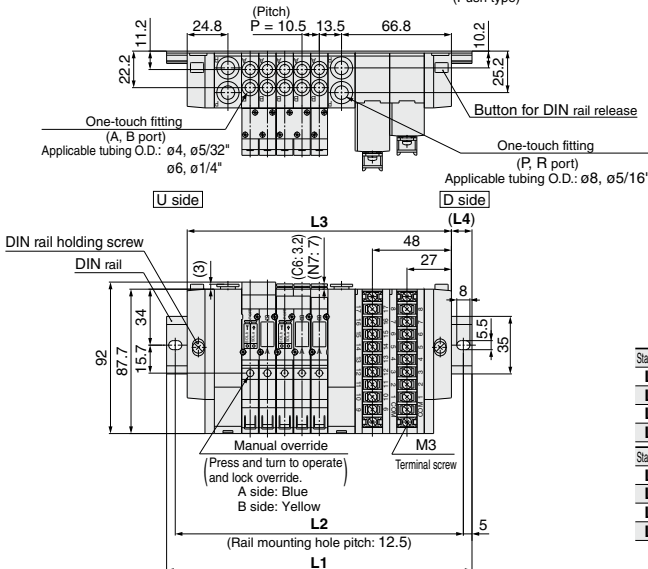

Stations n	2 stations	3	4	5	6	7	8	9 stations
L1	160.5	173	185.5	185.5	198	210.5	223	235.5
L2	150	162.5	175	175	187.5	200	212.5	225
L3	129	139.5	150	160.5	171	181.5	192	202.5
L4	15.5	16.5	17.5	12.5	13.5	14.5	15.5	16.5

Stations n	10 stations	11	12	13	14	15	16	17 stations
L1	248	248	260.5	273	285.5	298	310.5	310.5
L2	237.5	237.5	250	262.5	275	287.5	300	300
L3	213	223.5	234	244.5	255	265.5	276	286.5
L4	17.5	12	13	14	15	16	17	12

SJ
SY
SY
S0700
S0700

SY5000: 18 Pins Terminal Block/Plug-in

SS5Y5-45T1U - Stations D-C₄, N₃, C₆, N₇, C₈, N₉ (18 pins)

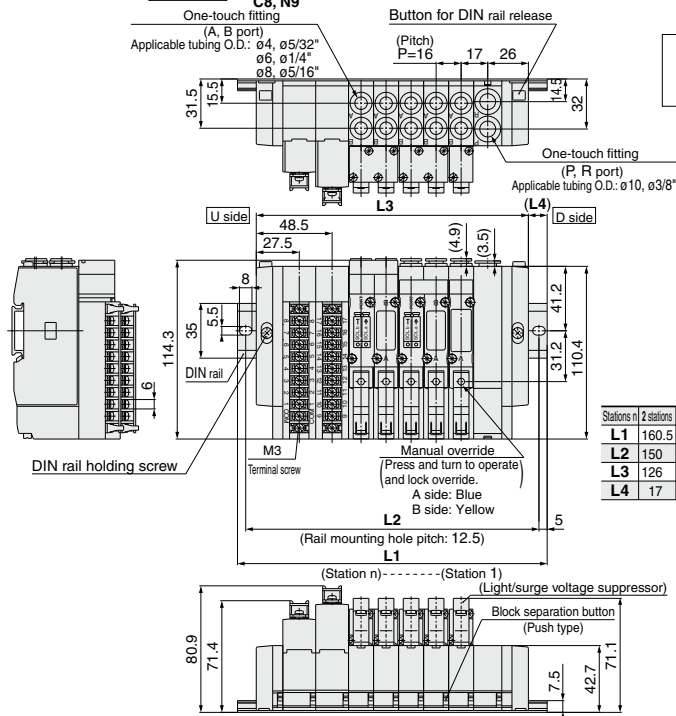

Note) The L1 to L4 dimensions of SS5Y5-45T1U - Stations U-C₄, N₃, C₆, N₇, C₈, N₉ are identical to those of SS5Y5-45T1U - Stations D-C₄, N₃, C₆, N₇, C₈, N₉

Stations n	2 stations	3	4	5	6	7	8	9	10 stations
L1	160.5	173	185.5	198	223	235.5	248	273	285.5
L2	150	162.5	175	187.5	212.5	225	237.5	262.5	275
L3	126	142	158	174	190	206	222	238	254
L4	17	15.5	13.5	12	16.5	14.5	13	17.5	15.5

SS5Y5-45T1U - Stations B-C₄, N₃, C₆, N₇, C₈, N₉ (18 pins)

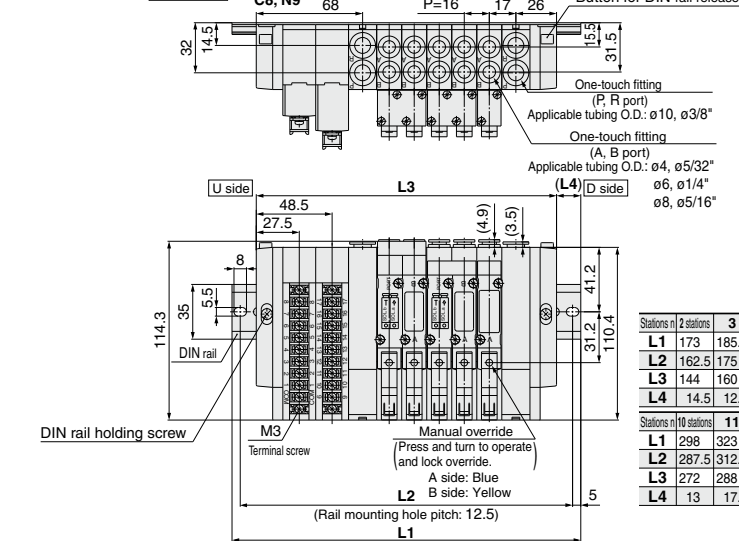

Stations n	2 stations	3	4	5	6	7	8	9 stations
L1	173	185.5	210.5	223	235.5	248	273	285.5
L2	162.5	175	200	212.5	225	237.5	262.5	275
L3	144	160	176	192	208	224	240	256
L4	14.5	12.5	17	15.5	13.5	12	16.5	14.5

Stations n	10 stations	11	12	13	14	15	16	17 stations
L1	298	323	335.5	348	360.5	385.5	398	410.5
L2	287.5	312.5	325	337.5	350	375	387.5	400
L3	272	288	304	320	336	352	368	384
L4	13	17.5	15.5	14	12	16.5	15	13

SY5000: 18 Pins Terminal Block/Plug-in

SS5Y5-45T1D- Stations U- C4, N3, C6, N7, C8, N9 (18 pins)

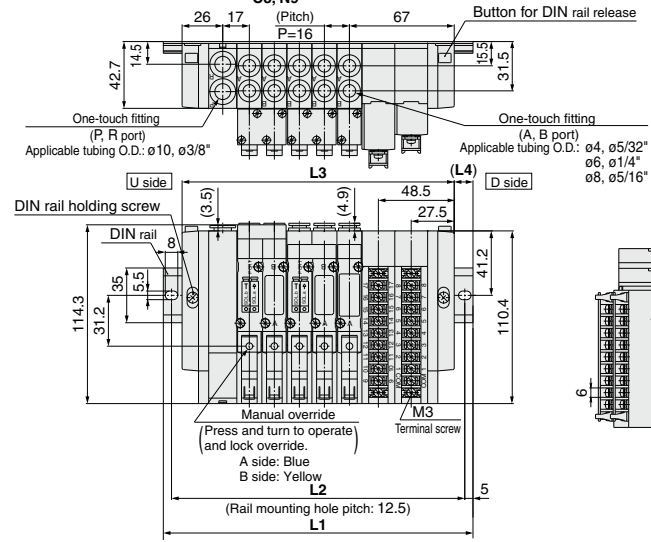

Note) The L1 to L4 dimensions of SS5Y5-45T1D- Stations U- C4, N3, C6, N7, C8, N9 are identical to those of SS5Y5-45T1D- Stations U- C4, N3, C6, N7, C8, N9

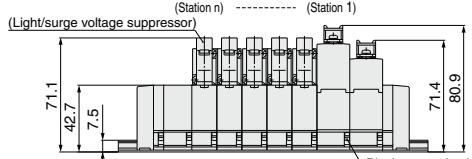
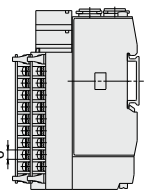

Stations n	2 stations	3	4	5	6	7	8	9	10 stations
L1	160.5	173	185.5	198	223	235.5	248	273	285.5
L2	150	162.5	175	187.5	212.5	225	237.5	262.5	275
L3	126	142	158	174	190	206	222	238	254
L4	17	15.5	13.5	12	16.5	14.5	13	17.5	15.5

SS5Y5-45T1D- Stations B- C4, N3, C6, N7, C8, N9 (18 pins)

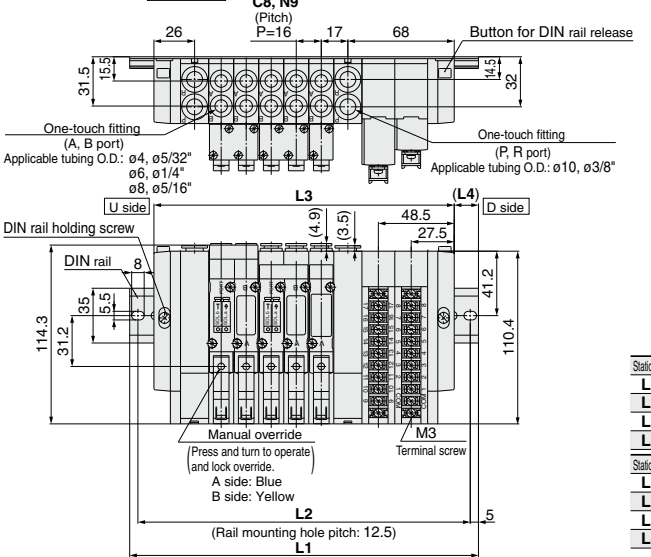

Stations n	2 stations	3	4	5	6	7	8	9 stations
L1	173	185.5	210.5	223	235.5	248	273	285.5
L2	162.5	175	200	212.5	225	237.5	262.5	275
L3	144	160	176	192	208	224	240	256
L4	14.5	12.5	17	15.5	13.5	12	16.5	14.5

Stations n	10 stations	11	12	13	14	15	16	17 stations
L1	298	323	335.5	348	360.5	385.5	398	410.5
L2	287.5	312.5	325	337.5	350	375	387.5	400
L3	272	288	304	320	336	352	368	384
L4	13	17.5	15.5	14	12	16.5	15	13

SJ
SY
SY
S0700
S0700

DIN Rail Manifold Exploded View

Type 45F (D-sub Connector) Manifold

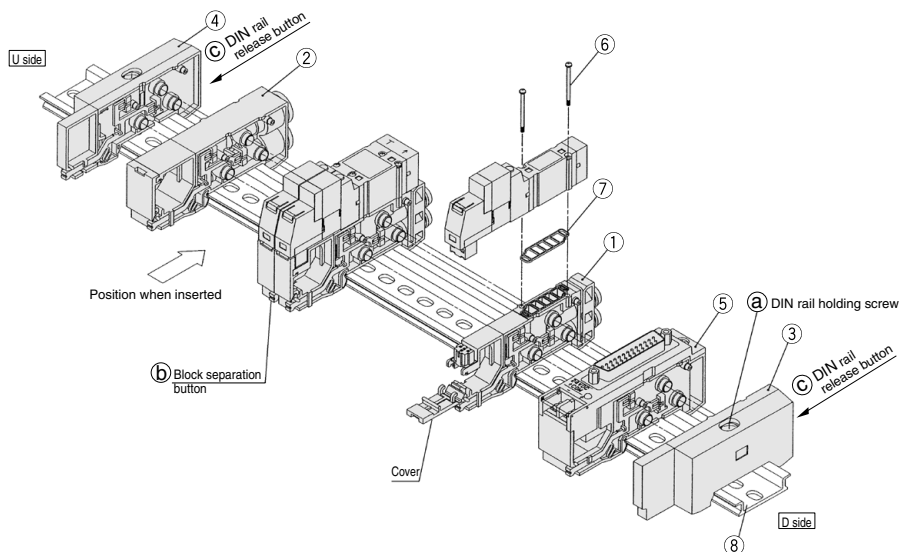

No.	Description	Part no.		Note
		SY3000	SY5000	
1	Manifold block assembly	Manifold block assembly part number differs according to an attached lead wire assembly based on the connector spec. Select an appropriate part number from the table of manifold block assembly part number shown below. (Gasket 7 is supplied as an accessory.)		
2	SUP/EXH block assembly	(Metric size) SX3000-51-2A (Inch size) SX3000-51-16A	(Metric size) SX5000-51-2A (Inch size) SX5000-51-16A	Metric size SY3000: P, R port with One-touch fitting for ø8 Inch size SY5000: P, R port with One-touch fitting for ø $\frac{3}{16}$ "
3	End block assembly	SX3000-52-2A(-Q)	SX5000-52-2A(-Q)	For D side
4	End block assembly	SX3000-53-2A(-Q)	SX5000-53-2A(-Q)	For U side
5-1	Connector block assembly (for D-sub connector)	SX3000-64- ^{1A} _{1NA}	SX5000-64- ^{1A} _{1NA}	-1A: +COM -1NA: -COM
5-2	Connector block assembly (for 26 pins flat cable)	SX3000-64- ^{2A} _{2NA} -26	SX5000-64- ^{2A} _{2NA} -26	Note) For 24 VDC
5-3	Connector block assembly (for 20 pins flat cable)	SX3000-64- ^{2A} _{2NA} -20	SX5000-64- ^{2A} _{2NA} -20	
5-4	Connector block assembly (for 10 pins flat cable)	SX3000-64- ^{2A} _{2NA} -10	SX5000-64- ^{2A} _{2NA} -10	
5-5	Connector block assembly (for 2 to 8 stations (T, T) terminal block)	SX3000-64-3A	SX5000-64-3A	In common between +COM and -COM.
5-6	Connector block assembly (for 3 to 17 stations (T) terminal block)	SX3000-64-8A	SX5000-64-8A	
6	Round head combination screw	SY3000-23-4	AC00077	
	Reference screw size	(M2 x 21)	(M3 x 26)	
7	Gasket	SX3000-57-4	SX5000-57-6	
8	DIN rail	VZ1000-11-1-□□		Refer to page 568.

Note 1) The numbers 5-1 to 4 are for 24 VDC. For 12 VDC, suffix "-12V" to the end of parts number. (Example) SX3000-64-1A-12 V

Note 2) Two manifold block assemblies are necessary for the double, 3 position (Dual body type).

Type of manifold	Manifold block assembly part no.	Note
For 45(N)F (D-sub connector)	SX ₅ 000-50-3A-□□(-Q)	□□: AB port SY3000 (metric size) (inch size) C4: With One-touch fitting for ø4 C6: With One-touch fitting for ø6 N3: With One-touch fitting for ø $\frac{3}{32}$ " N7: With One-touch fitting for ø $\frac{1}{4}$ "
For 45(N) _{FF} (Flat ribbon cable)	SX ₅ 000-50-5A-□□(-Q)	A, B port SY5000 (metric size) (inch size) C4: With One-touch fitting for ø4 C6: With One-touch fitting for ø6 C8: With One-touch fitting for ø8 N3: With One-touch fitting for ø $\frac{3}{32}$ " N7: With One-touch fitting for ø $\frac{1}{4}$ " N9: With One-touch fitting for ø $\frac{3}{16}$ "
For 45 _T (Terminal block)	SX ₅ 000-50-7A-□□(-Q)	

Note) The lead wire assembly is supplied with the manifold block assembly.

How to Increase Manifold Bases

- 1** Loosen DIN rail holding screw (a) fixing the manifold base until it begins to turn idly. (While pressing DIN rail releasing buttons (c) at two locations, separate the manifold base from the DIN rail.)
- 2** Additional bases are to be added to the U side. Press splitting button (b) of the manifold block assembly on the U side until button (b) locks, and then separate the block assemblies.
- 3** Separate the connector block assembly in the same manner as (2), and remove the connector mounting screw shown in Fig. 1.
- 4** Loosen the valve mounting screw on the U side, remove the valve, and take out the receptacle housing. (Refer to Fig. 2.)
- 5** Insert the common wire (red) of the manifold block assembly to be added into the pin insertion section (N mark) of the receptacle housing that was taken out in (4), mount it on the manifold block, and mount the removed valve.
- 6** As shown in Fig. 3, mount the additional manifold block assembly on the DIN rail on the U side. Refer to the circuit diagram, and insert the lead wire (black) as shown in Fig. 4.
- 7** Press the blocks against each other until a click sound is produced, place the lead wire in the manifold block, and close the lid without pinching the lead wire.
- 8** While lightly holding the blocks together so that there are no gaps between them, secure them to the DIN rail by tightening the DIN rail holding screws (a). Δ (Tightening torque: 1.4 N·m)

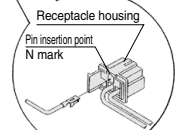
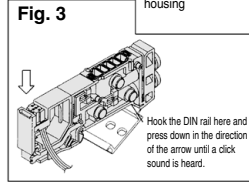
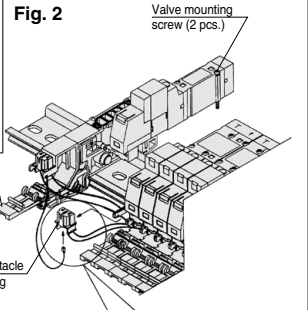
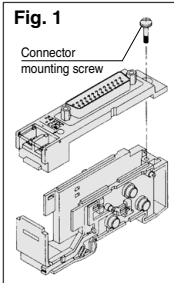
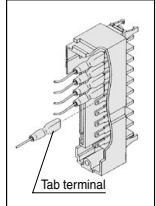
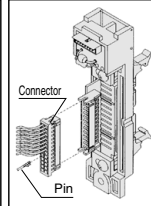
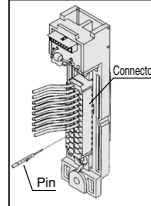

Fig. 4

D-sub connector (45F)

Flat ribbon cable (45P)

Terminal block (45T)



Note)
After inserting pins, lightly pull lead wires to check that pins are locked.

Note)
Insert pins after removing the connector from the main unit. After inserting pins, lightly pull lead wires to check that the pins are locked.

Note)
Insert tab terminals completely.

- Caution**
1. Depending on the connector, there is a limit to the number of solenoids that can be used. Manifold bases that can be added cannot exceed the number of usable solenoids.
 2. The manifold block assembly mounting position for additional manifold bases is always on the U side, because wires are connected to respective connectors sequentially from the D side.
 3. When DIN rail holding screw (a) for the end block is not sufficiently tightened during reassembly, air leakage may result. Before supplying air, check that there is no gap between blocks and that the manifold block is firmly fixed to the DIN rail in order to ensure air supply without leakage.

How to Change Fitting Assembly

Type 45 manifold permits change in the A and B port sizes by changing the manifold block fitting assembly. After removing the valve, remove the clip with a screwdriver, etc. For mounting a new fitting assembly, insert it and then insert a clip until it will not come out of the manifold block.

Fitting Assembly Part No.

Metric size

SY3000	One-touch fitting for ø4	VVQ1000-50A-C4
	One-touch fitting for ø6	VVQ1000-50A-C6
SY5000	One-touch fitting for ø4	VVQ1000-51A-C4
	One-touch fitting for ø6	VVQ1000-51A-C6
	One-touch fitting for ø8	VVQ1000-51A-C8

Inch size

SY3000	One-touch fitting for ø $\frac{5}{16}$ "	VVQ1000-50A-N3
	One-touch fitting for ø $\frac{1}{4}$ "	VVQ1000-50A-N7
SY5000	One-touch fitting for ø $\frac{5}{16}$ "	VVQ1000-51A-N3
	One-touch fitting for ø $\frac{1}{4}$ "	VVQ1000-51A-N7
	One-touch fitting for ø $\frac{3}{16}$ "	VVQ1000-51A-N9

Note 1) P and R ports cannot be changed.

Note 2) Use caution that O-rings must be free from scratches and dust. Otherwise, air leakage may result.

Note 3) Purchasing order is available in units of 10 pieces.

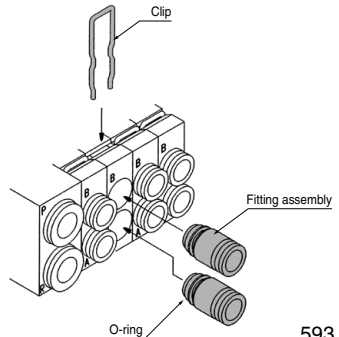

SY
S0700
S0700

Type **45S**

SY3000/5000 Base Mounted Manifold

Stacking Type/DIN Rail Mounted

EX122 Integrated-type (For Output) Serial Transmission System

Note) Refer to the SI unit part no. for the SI unit comparable with CE. [Option]



How to Order Manifold

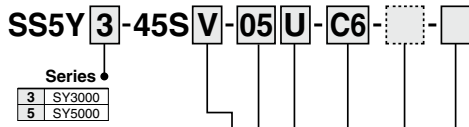

Series

3	SY3000
5	SY5000

SI unit specifications

Symbol	Protocol type
0	Without SI unit
H	NKE Corp.: Fieldbus H System
Q	DeviceNet
R1	OMRON Corp.: CompoBus/S (16 outputs) compatible
R2	OMRON Corp.: CompoBus/S (8 outputs) compatible
V	CC-LINK
ZB	CompoNet™ (Positive common)
ZBN	CompoNet™ (Negative common)

* Even though when it is not equipped with SI unit, DIN rail length is long enough for future expectancy of mounting SI unit.

Valve stations

Symbol	Stations	Note
02	2 stations	Single wiring spec. (Applicable up to 16 solenoid valves.)
:	:	
16	16 stations	

* This also includes the number of blanking plate assemblies.
* Two stations are necessary for the double, 3 position (Dual body type).

SUP/EXH block assembly mounting position

Symbol	Mounting position	Stations
U	U side	2 to 10 stations
D	D side	2 to 10 stations
B	(Both sides)	2 to 16 stations
M	Special specifications	

* For special specifications, indicate separately by the manifold specification sheet.

A, B port size

One-touch fitting (Metric size)			One-touch fitting (Inch size)		
Symbol	Port size	Applicable series	Symbol	Port size	Applicable series
C4	One-touch fitting for ø4	SY3000	N3	One-touch fitting for ø5/32	SY3000
C6	One-touch fitting for ø6				
M	Mixed				
C4	One-touch fitting for ø4	SY5000	N3	One-touch fitting for ø5/32	SY5000
C6	One-touch fitting for ø6				
C8	One-touch fitting for ø8				
M	Mixed		M	Mixed	

* In the case of mixed specifications, indicate separately on the manifold specification sheet.

SI Unit Part No.

Symbol	Protocol type	SI unit No.	CE-compliant
H	NKE Corp.: Fieldbus H System	EX122-SUH1	—
Q	DeviceNet	EX122-SDN1	○
R1	OMRON Corp.: CompoBus/S (16 outputs) compatible	EX122-SCS1	○
R2	OMRON Corp.: CompoBus/S (8 outputs) compatible	EX122-SCS2	○
V	CC-LINK	EX122-SM1	○
ZB	CompoNet™ (Positive common)	EX122-SCM1	○
ZBN	CompoNet™ (Negative common)	EX122-SCM3	○

Refer to page 777 and the Operation Manual for the details of EX122 Integrated-type (For Output) Serial Transmission System.
Please download the Operation Manual via our website, <http://www.smcworld.com>

How to Order Manifold Assembly (Example)

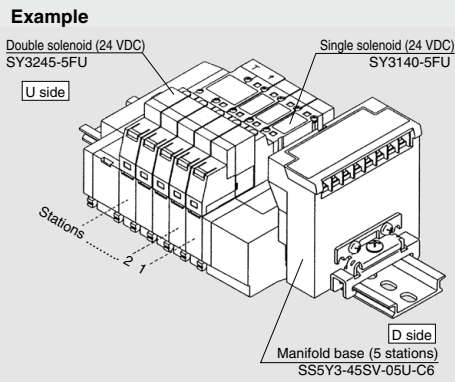

SS5Y3-45SV-05U-C6 ... 1 set (45S with SI unit 5-station manifold base part number)
 * SY3140-5FU 3 sets (Single solenoid part no.)
 * SY3245-5FU 1 set (Double solenoid part no.)

The asterisk denotes the symbol for assembly.
Prefix it to the part nos. of the solenoid valve, etc.

* The valve arrangement is numbered as the 1st. station from D side.
* When ordering double solenoid valves/3 position (Dual body type), please keep in mind that they require two manifold stations.
* SI unit is available only for the D-side mounting type.

How to Order Valve

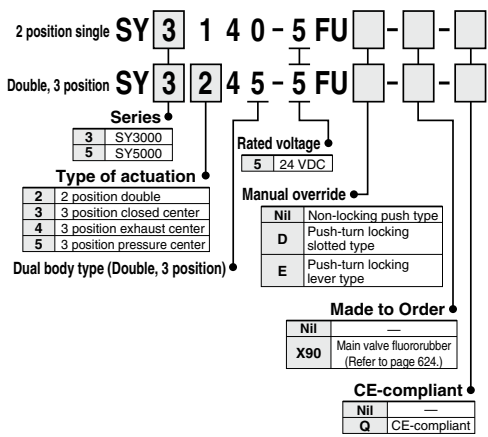

* When ordering plug-in type solenoid valve as a single unit, gaskets are not included. Order them separately, if necessary. (Refer to page 592 for details.)
* With light/surge voltage suppressor (Non-polar type)



SY5000 Series: EX122 Integrated-type (For Output) Serial Transmission System/Plug-in

SS5Y5-45S□ - Stations U

C4, N3
C6, N7
C8, N9

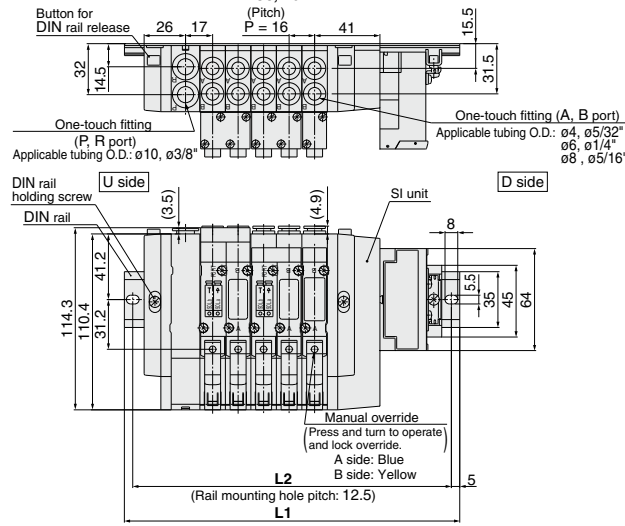

Note) The L1 to L4 dimensions of SS5Y5-45S□ - Stations U, C4, N3, C6, N7, C8, N9 are identical to those of SS5Y5-45S□ - Stations D, C4, N3, C6, N7, C8, N9

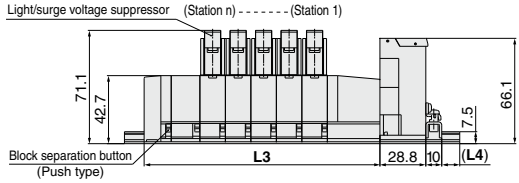
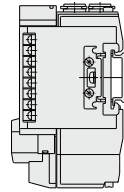

Stations n	2 stations	3	4	5	6	7	8	9	10 stations
L1	173	185.5	198	210.5	235.5	248	260.5	285.5	298
L2	162.5	175	187.5	200	225	237.5	250	275	287.5
L3	100	116	132	148	164	180	196	212	228
L4	17.5	15.5	14	12	16.5	15	13	17.5	16

SS5Y5-45S□ - Stations B

C4, N3
C6, N7
C8, N9

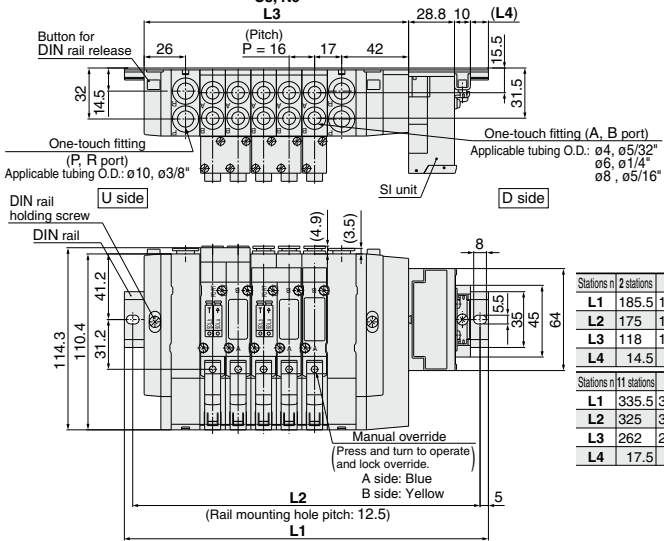

Stations n	2 stations	3	4	5	6	7	8	9	10 stations
L1	185.5	198	223	235.5	248	260.5	285.5	298	310.5
L2	175	187.5	212.5	225	237.5	250	275	287.5	300
L3	118	134	150	166	182	198	214	230	246
L4	14.5	13	17.5	15.5	14	12	16.5	15	13

Stations n	11 stations	12	13	14	15	16 stations
L1	335.5	348	360.5	373	398	410.5
L2	325	337.5	350	362.5	387.5	400
L3	262	278	294	310	326	342
L4	17.5	16	14	12.5	17	15

Type **45S1**

SY3000/5000 Base Mounted Manifold

Stacking Type/DIN Rail Mounted

EX 121 Separate Type (For Output) Serial Transmission System

Note) Refer to the SI unit part no. for the SI unit comparable with CE. [Option]



How to Order Manifold

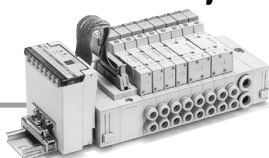

SS5Y **3** - 45S1 **V D** - **05 U** - **C4** - [] - []

Series

3	SY3000
5	SY5000

SI unit specifications

Symbol	Protocol type
0	Without SI unit
H	NKE Corp.: Fieldbus H System
Q	DeviceNet
R1	OMRON Corp.: CompoBus/S (16 outputs) compatible
R2	OMRON Corp.: CompoBus/S (8 outputs) compatible
V	CC-LINK
ZB	CompoNet™ (Positive common)
ZBN	CompoNet™ (Negative common)

• Even though when it is not equipped with SI unit, DIN rail length is long enough for future expectancy of mounting SI unit. When a shorter rail is required (same as type 45□), suffix "0" in the optional blank at the end of part number.

SI unit mounting position

Symbol	Mounting position
U	U side
D	D side

CE-compliant

Nii	—
Q	CE-compliant

* Refer to the SI unit part no. for the SI unit compatible with CE.

Option

When a longer DIN rail is desired than the specified stations, specify the station number to be required. (Max. 20 stations)

A, B port size

One-touch fitting (Metric size)

Symbol	Port size	Applicable series
C4	One-touch fitting for ø4	SY3000
C6	One-touch fitting for ø6	
M	Mixed	SY5000
C4	One-touch fitting for ø4	
C6	One-touch fitting for ø6	
C8	One-touch fitting for ø8	
M	Mixed	

One-touch fitting (Inch size)

Symbol	Port size	Applicable series
N3	One-touch fitting for ø 5/32"	SY3000
N7	One-touch fitting for ø 1/4"	
M	Mixed	SY5000
N3	One-touch fitting for ø 5/32"	
N7	One-touch fitting for ø 1/4"	
N9	One-touch fitting for ø 9/16"	
M	Mixed	

* In the case of mixed specifications, indicate separately on the manifold specification sheet.

SUP/EXH block assembly mounting position

Symbol	Mounting position	Stations
U	U side	2 to 10 stations
D	D side	2 to 10 stations
B	Both sides	2 to 16 stations
M	Special specifications	

* For special specifications, indicate separately by the manifold specification sheet.

Valve stations

Symbol	Stations	Note
02	2 stations	Single wiring spec. (Applicable up to 16 solenoid valves.)
:	:	
16	16 stations	

* This also includes the number of blanking plate assemblies.

* Two stations are necessary for the double, 3 position (Dual body type).

SI Unit Part No.

Symbol	Protocol type	SI unit No.	CE-compliant
H	NKE Corp.: Fieldbus H System	EX121-SUH1	—
Q	DeviceNet	EX121-SDN1	●
R1	OMRON Corp.: CompoBus/S (16 outputs) compatible	EX121-SCS1	●
R2	OMRON Corp.: CompoBus/S (8 outputs) compatible	EX121-SCS2	●
V	CC-LINK	EX121-SMJ1	●
ZB	Compo Net™ (Positive common)	EX121-SCM1	●
ZBN	CompoNet™ (Negative common)	EX121-SCM3	●

• For external pilot specifications and built-in silencer, refer to pages 616 to 620.

Refer to page 777 and the Operation Manual for the details of EX121 Separate Type (For Output) Serial Transmission System.
Please download the Operation Manual via our website, <http://www.smcworld.com>

SY

SY

SY

S0700

S0700

How to Order Valve Manifold Assembly (Example)

Example

Double solenoid (24 VDC)
SY3245-5FU

Single solenoid (24 VDC)
SY3140-5FU

U side

Stations 1 2 3 4 5

D side

Manifold base (5 stations)
SS5Y3-45S1VD-05U-C6

SS5Y3-45S1VD-05U-C6 ... 1 set (Type 45S1 with serial unit 5-station manifold base part no.)

- * SY3140-5FU..... 3 sets (Single solenoid part no.)
- * SY3245-5FU..... 1 set (Double solenoid part no.)

The asterisk denotes the symbol for assembly. Prefix it to the part nos. of the solenoid valve, etc.

- The valve arrangement is numbered as the 1st. station from D side regardless of the mounting position of SI unit.
- When ordering double solenoid valves/3 position (Dual body type), please keep in mind that they require two manifold stations.

How to Order Valve



2 position single **SY 3 1 40-5 FU** -

Double, 3 position **SY 3 2 45-5 FU** -

Series

3	SY3000
5	SY5000

Type of actuation

2	2 position double
3	3 position closed center
4	3 position exhaust center
5	3 position pressure center

Dual body type (Double, 3 position)

Rated voltage

5	24 VDC
---	--------

Manual override

Nil	Non-locking push type
D	Push-turn locking slotted type
E	Push-turn locking lever type

CE-compliant

Nil	—
Q	CE-compliant

- * When ordering plug-in type solenoid valve as a single unit, gaskets are not included. Order them separately, if necessary. (Refer to page 592 for details.)
- * With light/surge voltage suppressor (Non-polar type)

SY3000: EX121 Separate Type (For Output) Serial Transmission System/Plug-in

SS5Y3-45S1□U- Stations D- C4, N3
C6, N7

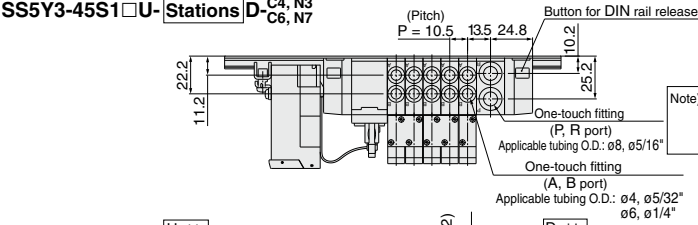

Note) The L1 to L4 dimensions of **SS5Y3-45S1□U- Stations U-** C4, N3
C6, N7 are identical to those of **SS5Y3-45S1□U- Stations D-** C4, N3
C6, N7.

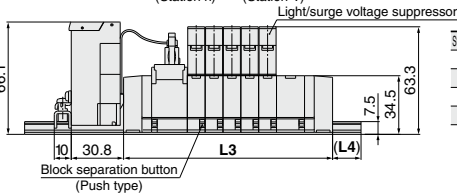
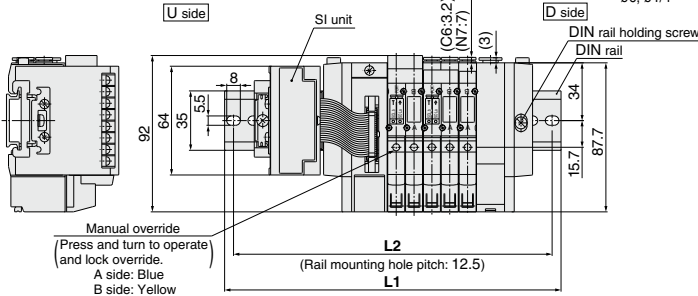

Stations n	2 stations	3	4	5	6	7	8	9	10 stations
L1	160.5	173	185.5	198	198	210.5	223	235.5	248
L2	150	162.5	175	187.5	187.5	200	212.5	225	237.5
L3	91.5	102	112.5	123	133.5	144	154.5	165	175.5
L4	14	15	16	17	12	13	14	15	16

SS5Y3-45S1□U- Stations B- C4, N3
C6, N7

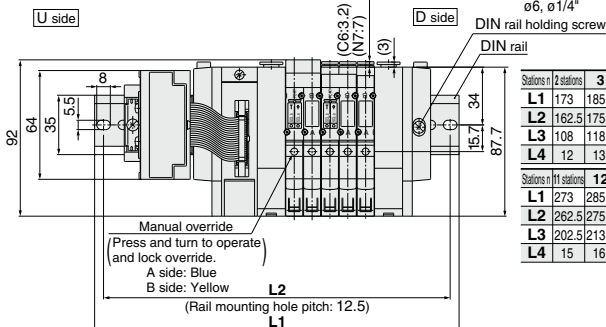
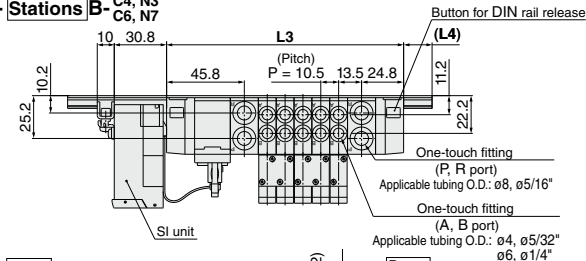

Stations n	11 stations	12	13	14	15	16 stations
L1	173	185.5	198	210.5	223	235.5
L2	162.5	175	187.5	200	212.5	225
L3	108	118.5	129	139.5	150	160.5
L4	12	13	14	15	16	17

Stations n	11 stations	12	13	14	15	16 stations
L1	273	285.5	298	298	310.5	323
L2	262.5	275	287.5	287.5	300	312.5
L3	202.5	213	223.5	234	244.5	255
L4	15	16	17	11.5	12.5	13.5

SY3000: EX121 Separate Type (For Output) Serial Transmission System/Plug-in

SS5Y3-45S1 □ D- Stations U- C4, N3 C6, N7

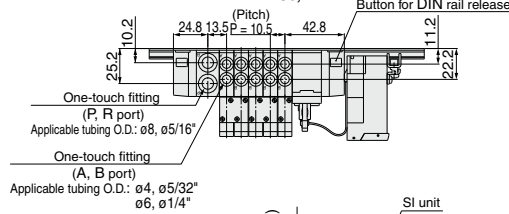

Note) The L1 to L4 dimensions of SS5Y3-45S1 □ D- Stations D- C4, N3, C6, N7 are identical to those of SS5Y3-45S1 □ D- Stations U- C4, N3, C6, N7.

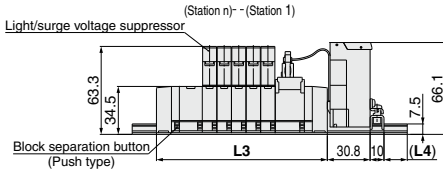
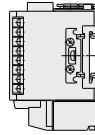
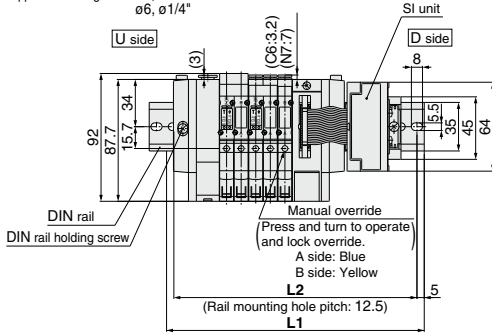

Stations n	2 stations	3	4	5	6	7	8	9	10 stations
L1	160.5	173	185.5	198	198	210.5	223	235.5	248
L2	150	162.5	175	187.5	187.5	200	212.5	225	237.5
L3	91.5	102	112.5	123	133.5	144	154.5	165	175.5
L4	14	15	16	17	12	13	14	15	16

SS5Y3-45S1 □ D- Stations B- C4, N3 C6, N7

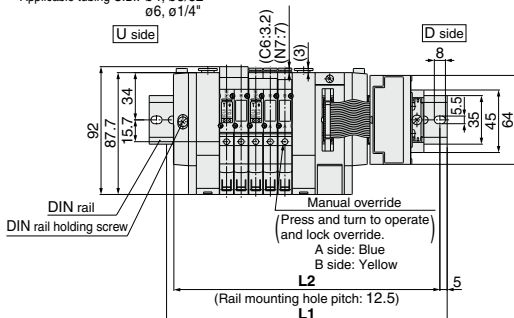
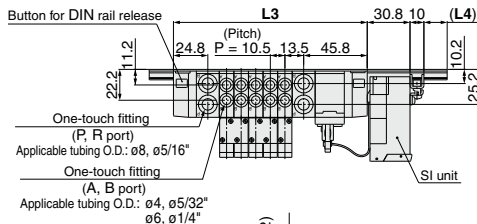

Stations n	2 stations	3	4	5	6	7	8	9	10 stations
L1	173	185.5	198	210.5	223	235.5	248	260.5	260.5
L2	162.5	175	187.5	200	212.5	225	225	237.5	250
L3	108	118.5	129	139.5	150	160.5	171	181.5	192
L4	12	13	14	15	16	17	12	13	14

Stations n	11 stations	12	13	14	15	16 stations
L1	273	285.5	298	298	310.5	323
L2	262.5	275	287.5	287.5	300	312.5
L3	202.5	213	223.5	234	244.5	255
L4	15	16	17	11.5	12.5	13.5

SY5000: EX121 Separate Type (For Output) Serial Transmission System/Plug-in

SS5Y5-45S1□U- Stations D- C4, N3
C6, N7
C8, N9

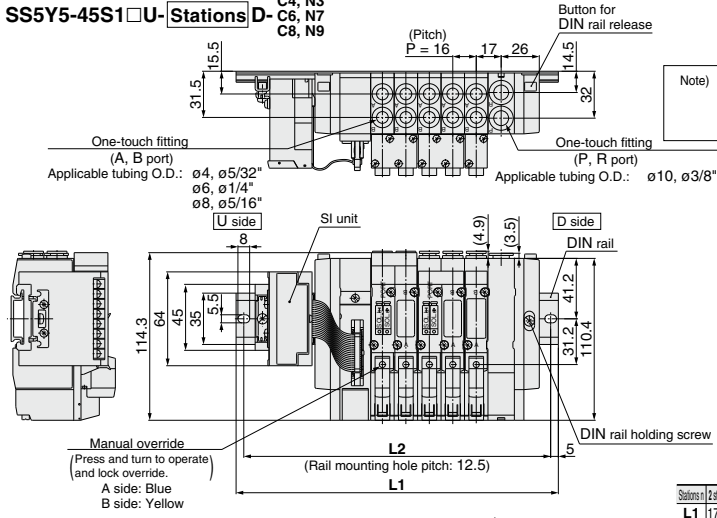

Note) The L1 to L4 dimensions of SS5Y5-45S1□U- Stations U-C4, N3, C6, N7, C8, N9 are identical to those of SS5Y5-45S1□U- Stations D-C4, N3, C6, N7, C8, N9.

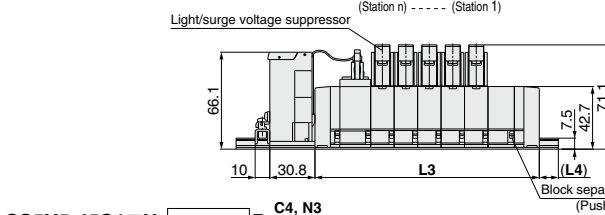

SJ
SY
SY
S0700
S0700

Stations	2 stations	3	4	5	6	7	8	9	10 stations
L1	173	185.5	210.5	223	235.5	260.5	273	285.5	298
L2	162.5	175	200	212.5	225	250	262.5	275	287.5
L3	105	121	137	153	169	185	201	217	233
L4	13.5	12	16.5	14.5	13	17.5	15.5	14	12

SS5Y5-45S1□U- Stations B- C4, N3
C6, N7
C8, N9

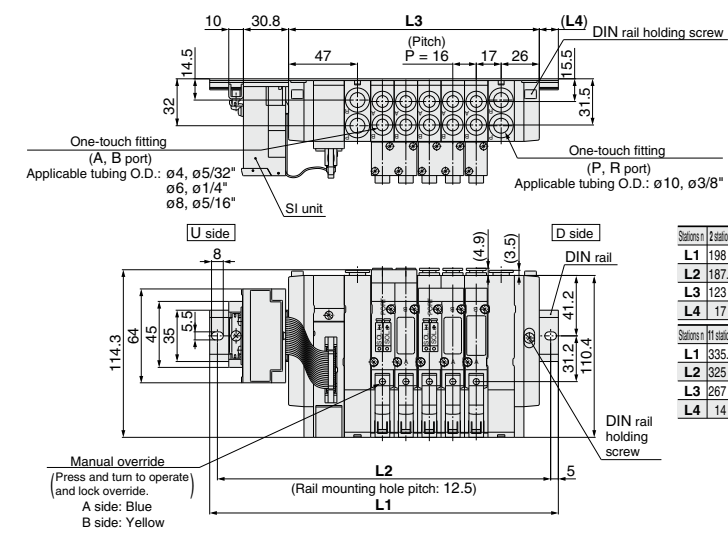

Stations	2 stations	3	4	5	6	7	8	9	10 stations
L1	198	210.5	223	235.5	260.5	273	285.5	310.5	323
L2	187.5	200	212.5	225	250	262.5	275	300	312.5
L3	123	139	155	171	187	203	219	235	251
L4	17	15.5	13.5	12	16.5	14.5	13	17.5	15.5

Stations	11 stations	12	13	14	15	16 stations
L1	335.5	348	373	385.5	398	410.5
L2	325	337.5	362.5	375	387.5	400
L3	267	283	299	315	331	347
L4	14	12	16.5	15	13	11.5

SJ
SY
SY
S0700
S0700

EX510 Gateway-type Serial Transmission System Base Mounted Manifold/Stacking Type/Plug-in Type



Type **45S6B**

SY3000/5000 Series

How to Order Manifold

SS5Y 3 - 45S6B - U - 02 U - C4 -

Manifold series

3	SY3000
5	SY5000

SI unit

Nil	NPN output (+COM.)
N	PNP output (-COM.)

SI unit mounting position

U	U side
D	D side

Valve stations

Symbol	Stations	Note
02	2 stations	Compatible with 16 solenoid valves
⋮	⋮	
16	16 stations	

*The number of the blanking plate assembly is also included.

CE-compliant

Nil	—
Q	CE-compliant

Option
When a DIN rail that is longer than the specified stations is desired, specify the required station number. (Max. 20 stations)

**A, B port size
One-touch fitting (Metric size)**

Symbol	Port size	Applicable series
C4	One-touch fitting for ø4	SY3000
C6	One-touch fitting for ø6	
M	Mixed	SY5000
C4	One-touch fitting for ø4	
C6	One-touch fitting for ø6	
C8	One-touch fitting for ø8	
M	Mixed	

One-touch fitting (Inch size)

Symbol	Port size	Applicable series
N3	One-touch fitting for ø5/32"	SY3000
N7	One-touch fitting for ø1/4"	
M	Mixed	
N3	One-touch fitting for ø5/32"	SY5000
N7	One-touch fitting for ø1/4"	
N9	One-touch fitting for ø5/16"	
M	Mixed	

* For the mixed specification, indicate separately on a manifold specification sheet.

Pilot specifications

Nil	Internal pilot
S	Internal pilot/built-in silencer
R	External pilot
RS	External pilot/built-in silencer

SUP/EXH block assembly mounting position

U	U side	2 to 10 stations
D	D side	
B	Both sides	2 to 16 stations
M	Special specifications*	

*For the special specifications, indicate separately on a manifold specification sheet.

SI unit part no.

Symbol	SI unit specifications	SI unit part no.	Page
Nil	NPN output (+COM.)	EX510-S002A	P.897
N	PNP output (-COM.)	EX510-S102A	

How to Order Manifold Assembly (Example)

Example

SS5Y3-45S6BD-05U-C6...1 set (45S6B type 5-station manifold part no.)
 *SY3140-5FU.....3 sets (Single solenoid part no.)
 *SY3245-5FU.....1 set (Double solenoid part no.)

*The asterisk denotes the symbol for assembly. Prefix to the part no. of the solenoid valve, etc.

- They will be assembled in the order listed starting at the first station at the D side whether the connector box is located at either end.
- When ordering double solenoid valves(3 position (dual body type), please keep in mind that they require two manifold stations.

Refer to page 878 and the Operation Manual for the details of EX510 Gateway-type Serial Transmission System. Please download the Operation Manual via our website, <http://www.smcworld.com>





[Option]

How to Order Valves

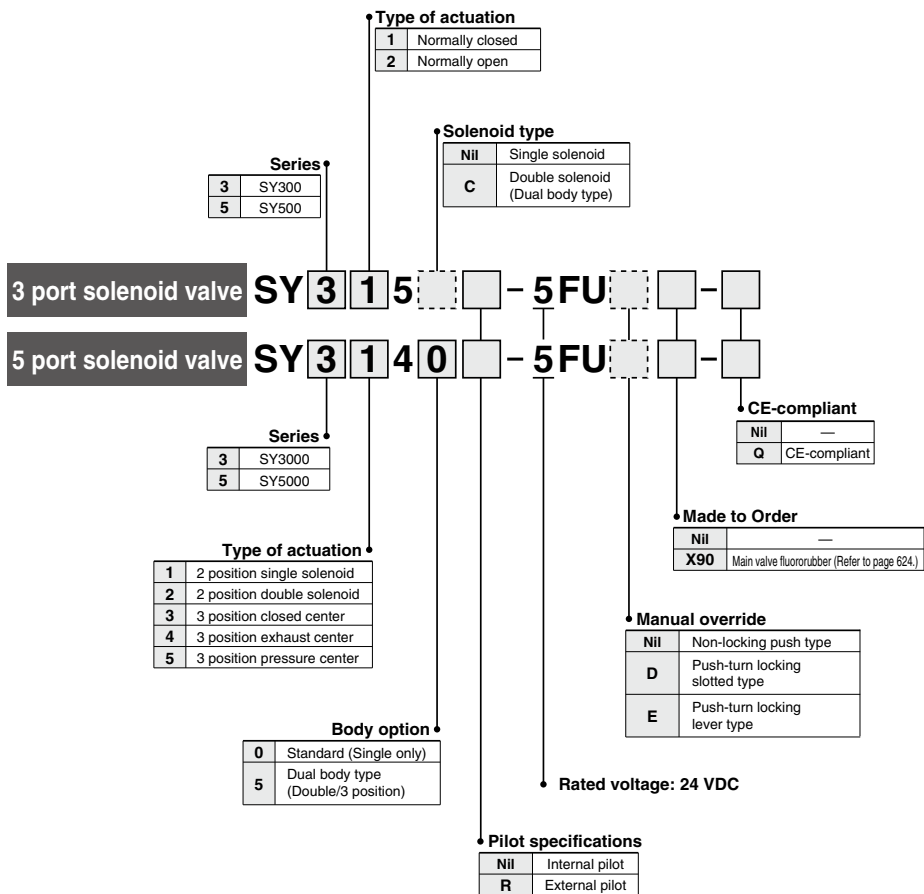

* When ordering plug-in type solenoid valve as a single unit, gaskets are not included. Order them separately, if necessary. (Refer to page 592 for details.)
 * With light/surge voltage suppressor (Non-polar type)

Type **45S6B** *SY3000/5000 Series*

Dimensions

SS5Y3-45S6B □ **D- Stations** U- ^{C4, N3} _{C6, N7}

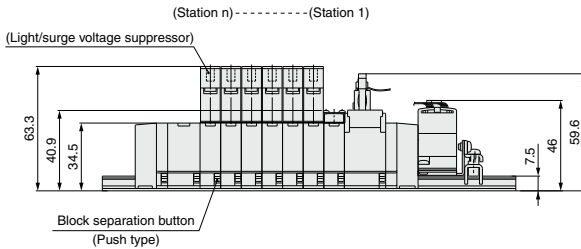
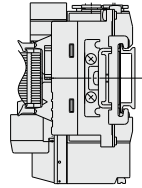
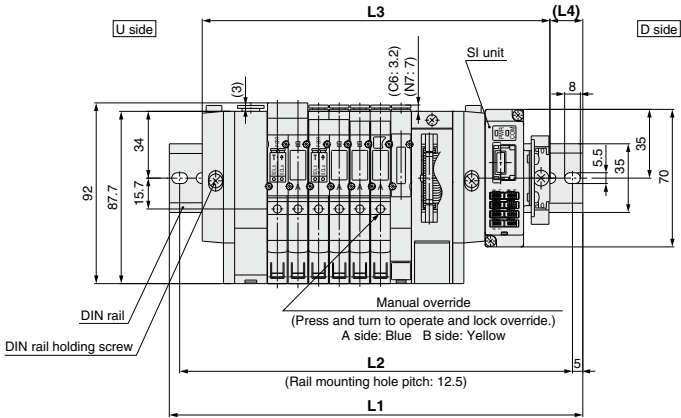
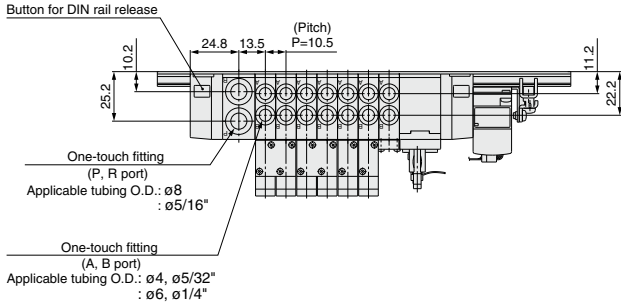

L: Dimensions

n: Stations

L \ n	2	3	4	5	6	7	8	9	10
L1	148	160.5	173	185.5	198	210.5	223	223	235.5
L2	137.5	150	162.5	175	187.5	200	212.5	212.5	225
L3	124.5	135	145.5	156	166.5	177	187.5	198	208.5
L4	12	13	14	15	16	17	18	12.5	13.5

Dimensions

SS5Y3-45S6B U- Stations B- C4, N3
C6, N7

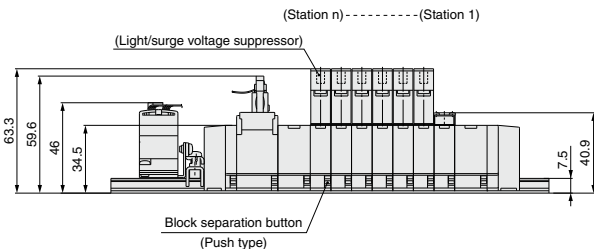
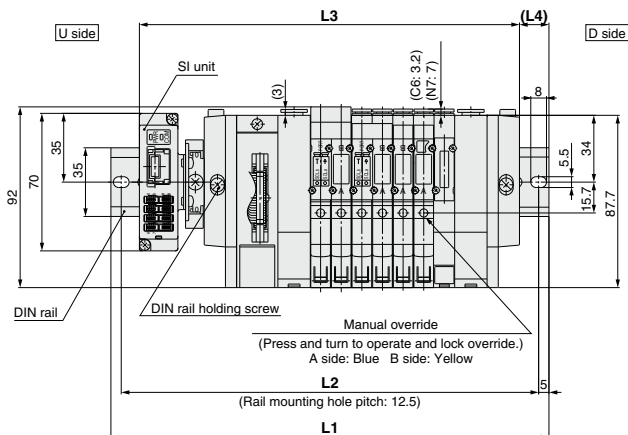
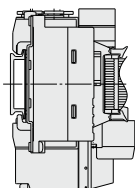
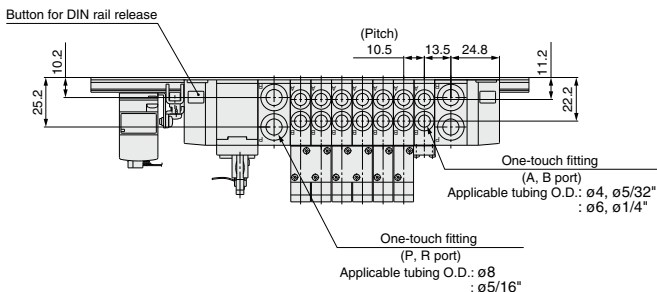

L: Dimensions

n: Stations

L \ n	2	3	4	5	6	7	8	9	10	11	12	13	14	15	16
L1	173	185.5	198	198	210.5	223	235.5	248	260.5	273	273	285.5	298	310.5	323
L2	162.5	175	187.5	187.5	200	212.5	225	237.5	250	262.5	262.5	275	287.5	300	312.5
L3	141	151.5	162	172.5	183	193.5	204	214.5	225	235.5	246	256.5	267	277.5	288
L4	16	17	18	13	14	15	16	17	18	19	13.5	14.5	15.5	16.5	17.5

SJ
SY
SY
S0700
S0700

Type **45S6B** **SY3000/5000 Series**

Dimensions

SS5Y5-45S6B □ **D** Stations **U** C4, N3
C6, N7
C8, N9

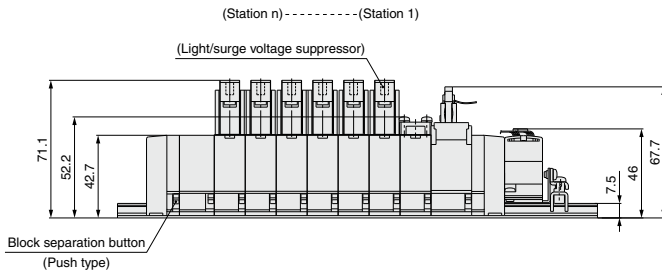
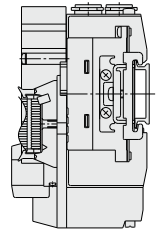
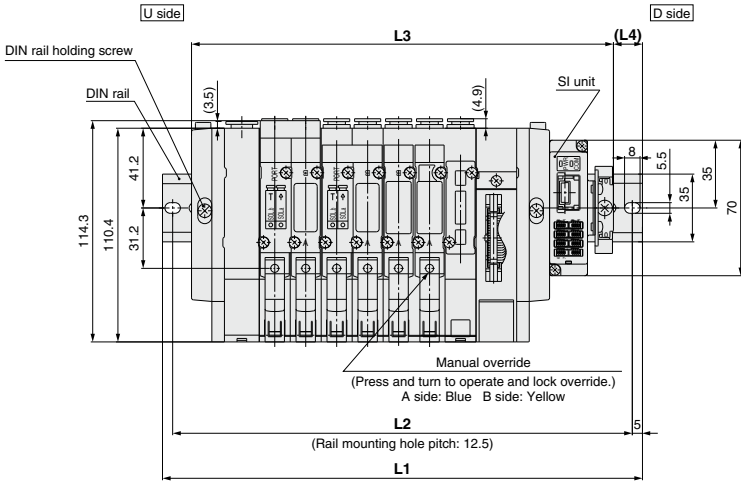
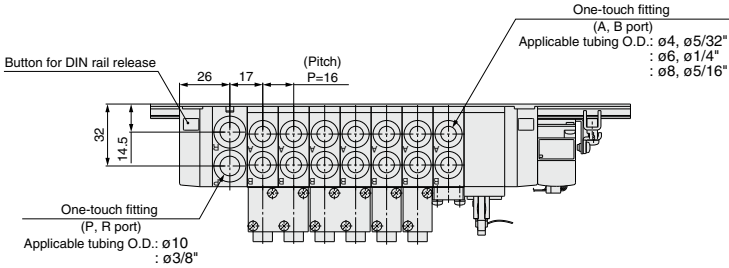

L: Dimensions

n: Stations

L \ n	2	3	4	5	6	7	8	9	10
L1	173	185.5	198	210.5	235.5	248	260.5	285.5	298
L2	162.5	175	187.5	200	225	237.5	250	275	287.5
L3	138	154	170	186	202	218	234	250	266
L4	17.5	16	14	12.5	17	15	13.5	18	16

Manifold Option

■ Blanking plate assembly

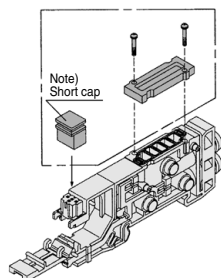

Series	Assembly part no.
SY3000	SX3000-75-2A(-Q)
SY5000	SX5000-76-6A(-Q)

Note) When mounting blanking plate, be sure to mount a short cap.

- Two stations are necessary for the double, 3 position (Dual body type).

■ SUP blocking disk

By installing a SUP blocking disk in the pressure supply passage of a manifold valve, it is possible to supply two or more different high and low pressures to one manifold.



Series	Part no.
SY3000	SX3000-77-1A
SY5000	SX5000-77-1A

■ EXH blocking disk

By installing an EXH blocking disk in the exhaust passage of a manifold valve, it is possible to divide the valve's exhaust so that it does not affect another valve. (Two blocking disks are needed to divide both exhausts.)



Series	Part no.
SY3000	SX3000-77-1A
SY5000	SX5000-77-1A

■ Label for block disk

The labels shown below are used on manifold stations containing SUP/EXH block disk(s) to show their location. (3 pcs. each)
VZ3000-123-1A (In common with SY3000, 5000)

Label for SUP block disk Label for EXH block disk Label for SUP/EXH block disk



Note) When a block disk is concurrently ordered by specifying on the manifold specification sheet, etc., a label will be stuck on the position where block disk is mounted.

■ Silencer with One-touch fitting

The silencer plugs directly into the One-touch fittings of the manifold.

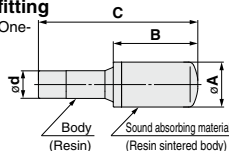

Series	Model	Effective area mm ²	A	B	C
For SY3000 (ø8)	AN15-C08	20	ø13	20	45
For SY5000 (ø10)	AN20-C10	30	ø16.5	30.5	57.5

■ Plug

These are inserted in unused cylinder ports and SUP, EXH ports. Purchasing order is available in units of 10 pieces.

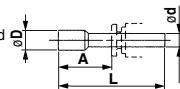

Dimensions

Applicable fittings size ϕD	Model	A	L	D
4	KQ2P-04	16	32	6
6	KQ2P-06	18	35	8
8	KQ2P-08	20.5	39	10
10	KQ2P-10	22	43	12
1/8"	KQ2P-01	16	31.5	5
5/32"	KQ2P-03	16	32	6
1/4"	KQ2P-07	18	35	8.5
5/16"	KQ2P-09	20.5	39	10

⚠ Caution

Mounting screw tightening torques

M2: 0.16 N-m
M3: 0.8 N-m
M4: 1.4 N-m

■ Individual EXH spacer assembly

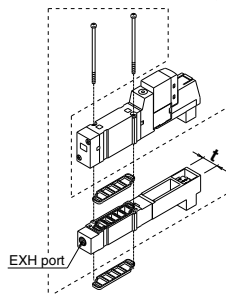

■ Individual SUP spacer assembly

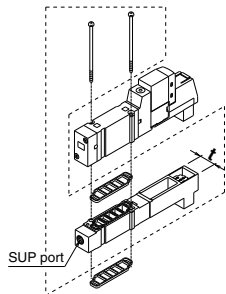

Series	Assembly part no.	Port no.	t
SY3000	SY3000-39-3A(-Q)	M5 x 0.8	11
SY5000	SY5000-39-17A(-Q)	1/8	15

Note) Please be careful because the dual body type (double solenoid, 3-position) requires two pieces. In this case, the exhaust is performed in the direction of the arrow mark indicated on the valve surface.

Series	Assembly part no.	Port no.	t
SY3000	SY3000-38-3A(-Q)	M5 x 0.8	11
SY5000	SY5000-38-17A(-Q)	1/8	15

Note) Please be careful because the dual body type (double solenoid, 3-position) requires two pieces. In this case, both supply ports require the piping.

3 Port Valve Mixed Mounting Type on 5 Port Valve Manifold **SY300/500 Series**

3 port valve can be mounted on manifold for 5 port valve.



Single Unit

Brackets and sub-plates are the same as the SY3000/5000 series.

Applications

Possible to be mounted on all kinds of manifolds for the SY3000/5000 series.
Refer to "How to Order Manifold" for the details.

How to Order Manifold Assembly (Example)

Example

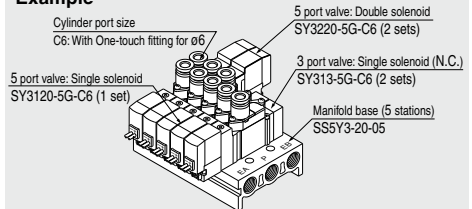

- SS5Y3-20-05 1 set (Type 20, 5-station manifold base part no.)
 * SY313-5G-C6 ... 2 sets (3 port valve, type NC part no.)
 * SY3120-5G-C6 ... 1 set (5 port valve, single solenoid part no.)
 * SY3220-5G-C6 ... 2 sets (5 port valve, double solenoid part no.)

The asterisk denotes the symbol for assembly.
Prefix it to the part nos. of the solenoid valve, etc.

Add the valve and option part number under the manifold base part number. In the case of complex arrangement, specify them on the manifold specification sheet.

Specifications

Dimensions, specifications, solenoid specifications, response time and effective area are the same as 5 port valve.



Body Ported/How to Order Valve

Note) AC-type models that are CE-compliant have DIN terminals only. [Option] (Details→P.632)

For single and individual wiring: For SS5Y³₅-20

SY 5 1 3 [] [] - **5 L** [] [] - **01** [] [] [] [] []

Series

3	SY300
5	SY500

Type of actuation

1	Normally closed (N.C.)
2	Normally open (N.O.)

Solenoid type

Nil	Single solenoid
D	Double solenoid

Coil specifications

Nil	Standard
T	With power saving circuit (24 VDC, 12 VDC only)

* Power saving circuit is not available in the case of D, Y, DO, YO or W□ type.

Rated voltage

For DC		For AC	
5	24 VDC	1	100 VAC
6	12 VDC	2	200 VAC
V	6 VDC	3	110 VAC [115 VAC]
S	5 VDC	4	220 VAC [230 VAC]
R	3 VDC		

* DC specifications of Type D, Y, DO and YO is only available with 12 and 24 VDC.

* For type W□, DC voltage is only available.

Note) AC-type models that are CE-compliant have DIN terminals only.

Electrical entry

24, 12, 6, 5, 3 VDC 100, 110, 200, 220 VAC			24, 12 VDC 100, 110, 200, 220 VAC		24, 12 VDC 6, 5, 3 VDC	
Grommet	L plug connector	M plug connector	DIN terminal	M8 connector		
G: Lead wire length 300 mm	L: With lead wire (Length 300 mm)	M: With lead wire (Length 300 mm)	(SY500 only) D: With connector DO: Without connector Y: With connector YO: Without connector	WO: Without connect or cable W□: With connect or cable		
H: Lead wire length 600 mm	LN: Without lead wire LO: Without connector	MN: Without lead wire MO: Without connector				
CE-compliant	DC					
	AC					

* LN, MN type: with 2 sockets.

* Refer to page 639 for DIN terminal type of the SY3000 series.

* "Y" type is a DIN terminal conforming to EN-175301-803C (former DIN43650C). For details, refer to page 638.

* For connector cable of M8 connector, refer to page 641.

* M8 connector conforming to IEC60947-5-2 standard is also available. Refer to page 623 for details.

* Refer to page 638 for the lead wire length of L and M plug connectors.

* Refer to page 639 for the connector assembly with cover for L and M plug connectors.

Note) Enter the cable length symbols in □. Please be sure to fill in the blank referring to page 642.

Thread type

Nil	Rc
F	G
N	NPT
T	NPTF

* Except for M5

Made to Order

Nil	—
X20	Body ported external pilot (Refer to page 624.)
X90	Main valve fluororubber (Refer to page 624.)

CE-compliant

Nil	—
Q	CE-compliant

Note) AC-type models that are CE-compliant have DIN terminals only.

Bracket

Nil	Without bracket
F1	With foot bracket (Single solenoid type only)
F2	With side bracket

* Brackets are the same as the SY3000/5000 series.

* For bracket pin number, refer to page 407.

A port size

Thread piping

Symbol	Port size	Applicable series
M5	M5 x 0.8	SY300
01	1/8	SY500

One-touch fitting (Metric size)

Symbol	Port size	Applicable series
C4	One-touch fitting for ø4	SY300
C6	One-touch fitting for ø6	
C4	One-touch fitting for ø4	SY500
C6	One-touch fitting for ø6	
C8	One-touch fitting for ø8	

One-touch fitting (Inch size)

Symbol	Port size	Applicable series
N3	One-touch fitting for ø9/32	SY300
N7	One-touch fitting for ø1/4"	
N3	One-touch fitting for ø9/32	SY500
N7	One-touch fitting for ø1/4"	
N9	One-touch fitting for ø5/16"	

Manual override

Nil	Non-locking push type
D	Push-turn locking slotted type
E	Push-turn locking lever type

Light/Surge voltage suppressor

Electrical entry for G, H, L, M, W

Nil	Without light/surge voltage suppressor
S	With surge voltage suppressor
Z	With light/surge voltage suppressor
R	With surge voltage suppressor (Non-polar type)
U	With light/surge voltage suppressor (Non-polar type)

* For AC voltage valves there is no "S" option. It is already built-in to the rectifier circuit.

* For "R" and "U", DC voltage is only available.

* Power saving circuit is only available in the "Z" type.

Electrical entry for D, Y (SY500 only)

Nil	Without light/surge voltage suppressor
S	With surge voltage suppressor
Z	With light/surge voltage suppressor

* DOZ and YOZ are not available.

* For AC voltage valves there is no "S" option. It is already built-in to the rectifier circuit.

Note) When placing an order for body ported solenoid valve as a single unit, mounting screw for manifold and gasket are not attached. Order them separately, if necessary.

Gasket assembly part no.

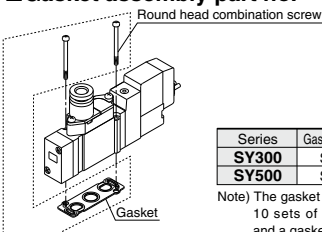

Series	Gasket assembly part no.
SY300	SY3000-GS-1
SY500	SY5000-GS-1

Note) The gasket assembly includes 10 sets of mounting screws and a gasket.



Base Mounted/How to Order Valve

Note) CE-compliant:
For DC only.

[Option]

Flat ribbon cable:
Connector box type: For SS5Y³-41P/42P/45-A

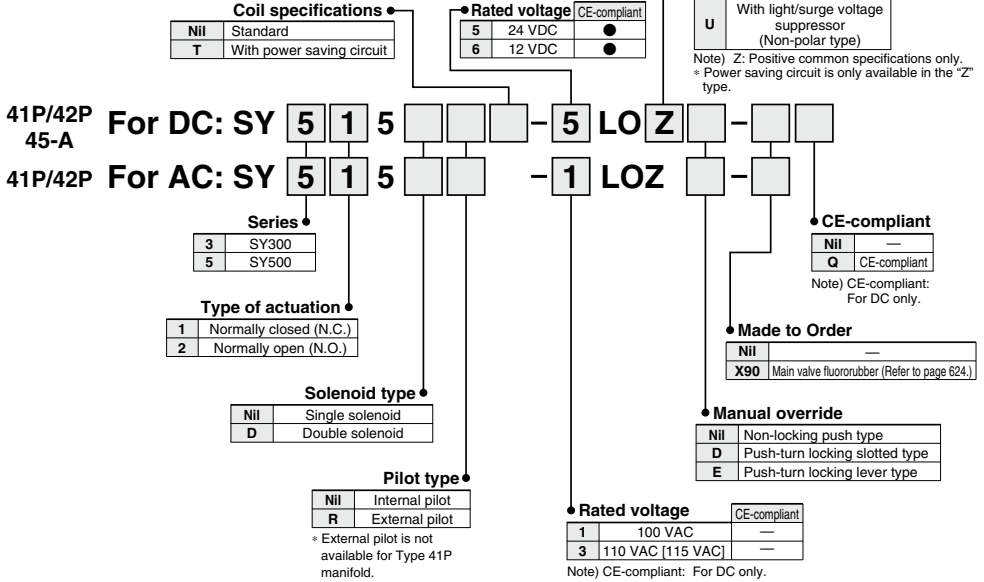

SJ
SY
SY
S0700
S0700

Plug-in: For SS5Y³-45□

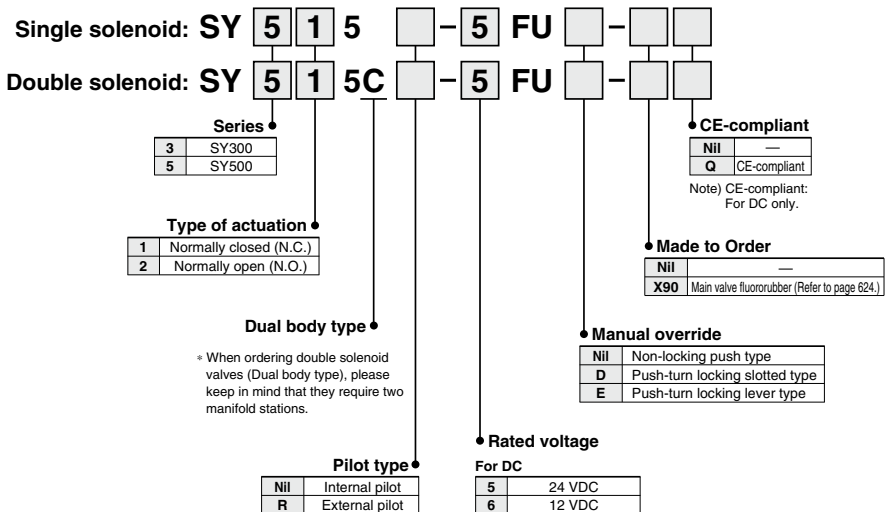

SY300/500 Series

Construction: Body Ported

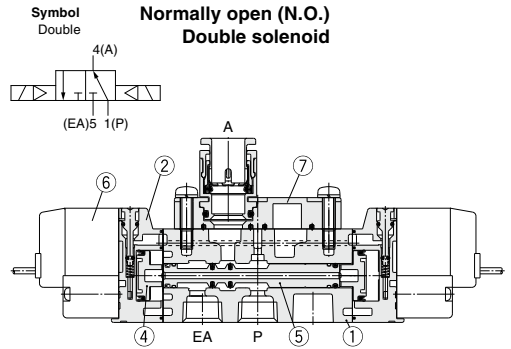
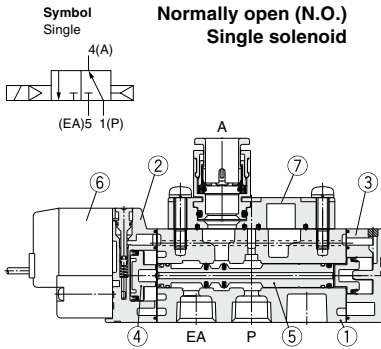
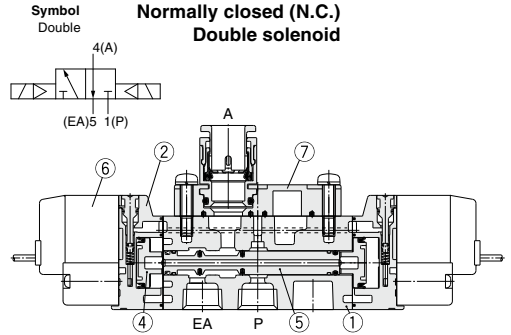
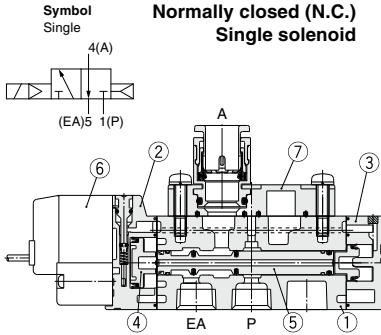

Component Parts

No.	Description	Material	Note
1	Body	Aluminum die-casted (SY300); Zinc die-casted (SY500)	White
2	Adapter plate	Resin	White
3	End plate	Resin	White
4	Piston	Resin	-
5	Spool valve assembly	Aluminum, H-NBR	-

Replacement Parts

No.	Description	No.
6	Pilot valve assembly	Refer to "How to Order Pilot Valve Assembly" on page 629.
7	M5 port block assembly	Refer to "How to Order Port Block Assembly" below.

How to Order M5 Port Block Assembly

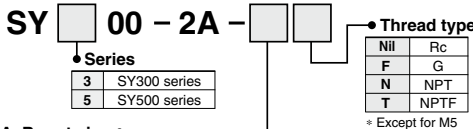

A, B port size

Thread piping

Symbol	Port size	Applicable series
M5	M5 x 0.8	SY300
O1	1/6	SY500

One-touch fitting (Metric size)

Symbol	Port size	Applicable series
C4	One-touch fitting for ø4	SY300
C6	One-touch fitting for ø6	
C4	One-touch fitting for ø4	SY500
C6	One-touch fitting for ø6	
C8	One-touch fitting for ø8	

One-touch fitting (Inch size)

Symbol	Port size	Applicable series
N3	One-touch fitting for ø3/32	SY300
N7	One-touch fitting for ø1/4	
N3	One-touch fitting for ø5/32	SY500
N7	One-touch fitting for ø1/4	
N9	One-touch fitting for ø9/16	



Caution

Mounting screw tightening torques

SY300 (M2) : 0.12 N·m
SY500 (M3) : 0.6 N·m

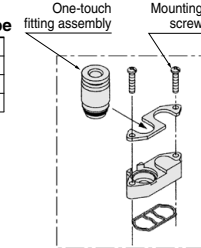

* Only replacement of the fittings assembly is possible.

Metric size

SY300	One-touch fitting for ø4	VVQ1000-50A-C4
	One-touch fitting for ø6	VVQ1000-50A-C6
SY500	One-touch fitting for ø4	VVQ1000-51A-C4
	One-touch fitting for ø6	VVQ1000-51A-C6
	One-touch fitting for ø8	VVQ1000-51A-C8

Inch size

SY300	One-touch fitting for ø3/32	VVQ1000-50A-N3
	One-touch fitting for ø1/4	VVQ1000-50A-N7
SY500	One-touch fitting for ø3/32	VVQ1000-51A-N3
	One-touch fitting for ø1/4	VVQ1000-51A-N7
	One-touch fitting for ø9/16	VVQ1000-51A-N9

Construction: Base Mounted

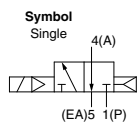

**Normally closed (N.C.)
Single solenoid**

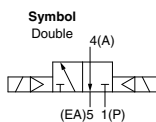
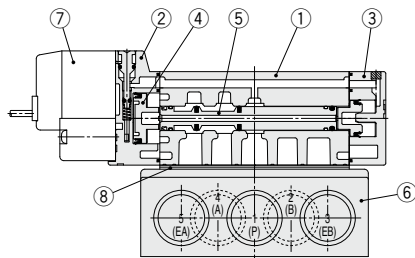

**Normally closed (N.C.)
Double solenoid**

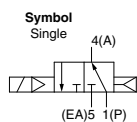
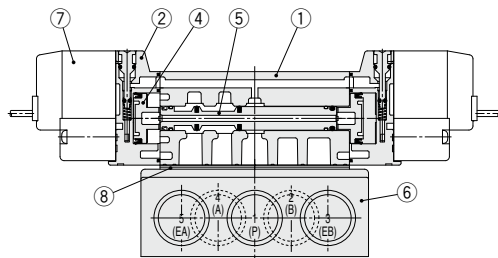

**Normally open (N.O.)
Single solenoid**

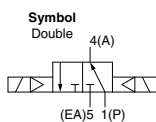
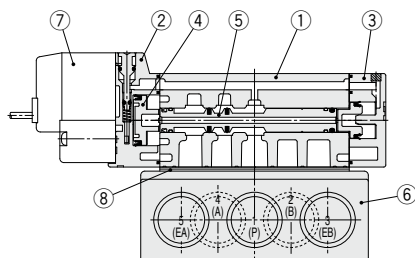

**Normally open (N.O.)
Double solenoid**

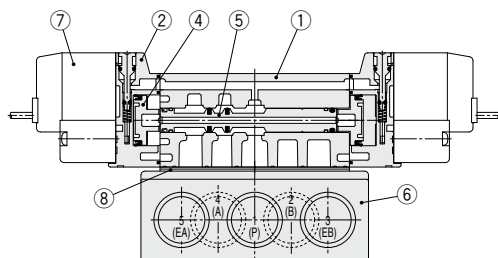

SJ
SY
SY
S0700
S0700

Component Parts

No.	Description	Material	Note
1	Body	Aluminum die-casted (SY3000: Zinc die-casted)	White
2	Adapter plate	Resin	White
3	End plate	Resin	White
4	Piston	Resin	—
5	Spool valve assembly	Aluminum, H-NBR	—

Replacement Parts

No.	Description	Part No.			Note
		SY3□40	SY5□40	SY7□40	
6	Sub-plate ^(Note)	SY3000-27-1□	SY5000-27-1□	1/4:SY7000-27-1□ 3/8:SY7000-27-2□	Aluminum die-casted
7	Pilot valve assembly	Refer to "How to Order Pilot Valve Assembly" on page 629.			
8	Standard	SY3000-11-25	SY5000-11-15	SY7000-11-11	H-NBR
	CE-compliant	SY3000-11-25	SY5000-11-18	SY7000-11-14	
—	Round head combination screw	SY3000-23-4	AC00077	AC00296	For valve mounting (Matt nickel plated)
—	Reference screw size	(M2 x 21)	(M3 x 26)	(M4 x 31)	

* Thread type

⚠ Caution

Mounting screw tightening torques

M2: 0.16 N·m
M3: 0.8 N·m
M4: 1.4 N·m

Weight

Body ported

SY300 series

Valve model	Type of actuation	Weight (g)	
		Grommet	L, M plug connector
SY3□3-□□-M5	Single	51	53
	Double	68	74
SY3□3-□□-C4 N3	Single	56	59
	Double	74	79
SY3□3-□□-C6 N7	Single	54	57
	Double	72	77

Base mounted

SY300 series

Valve model	Type of actuation	Weight (g)	
		Grommet	L, M plug connector
SY3□5-□□	Single	47(82)	50(85)
	Double	65(100)	70(105)

Note) The values shown in () are for values with sub-plate.

SY500 series

Valve model	Type of actuation	Weight (g)		
		Grommet	L, M plug connector	DIN terminal
SY5□3-□□-01□	Single	69	72	93
	Double	87	93	135
SY5□3-□□-C4 N3	Single	82	82	103
	Double	100	102	144
SY5□3-□□-C6 N7	Single	79	77	98
	Double	97	98	140
SY5□3-□□-C8 N9	Single	75	84	105
	Double	93	105	147

SY500 series

Valve model	Type of actuation	Weight (g)		
		Grommet	L, M plug connector	DIN terminal
SY5□5-□□	Single	55(118)	58(121)	79(142)
	Double	73(136)	78(141)	120(183)

Note) The values shown in () are for values with sub-plate.

SJ

SY

SY

S0700

S0700

SY3000/5000

Made to Order

External Pilot/Built-in Silencer

External pilot manifold bases for low-pressure/vacuum use are added to split type/
DIN rail manifolds. The built-in silencer has materialized a clear-cut appearance.



[Option]

Note) AC-type models that are CE-compliant have DIN terminals only.

Type 45

Individual Wiring/Connector Box Type

How to Order Manifold

Type 45

SS5Y³5-45(-A)-05U R-C6-

Series

3	SY3000
5	SY5000

Valve stations

Symbol	Stations
02	2 stations
:	:
20	20 stations

* The number of blanking plate assembly is included.

SUP/EXH block assembly mounting position

Symbol	Mounting position	Stations
U	U side	
D	D side	2 to 10 stations
B	Both sides	2 to 20 stations
M	Special specifications	

* For special specifications, indicate separately by the manifold specification sheet.

SUP/EXH block assembly specifications

Symbol	Specifications
R	External pilot specifications
S	Internal pilot/Built-in silencer
RS	External pilot/Built-in silencer

A, B port size

One-touch fitting (Metric size)

Symbol	Port size	Applicable series
C4	One-touch fitting for ø4	SY3000
C6	One-touch fitting for ø6	
M	Mixed	
C4	One-touch fitting for ø4	SY5000
C6	One-touch fitting for ø6	
C8	One-touch fitting for ø8	
M	Mixed	

One-touch fitting (Inch size)

Symbol	Port size	Applicable series
N3	One-touch fitting for ø $\frac{5}{32}$ "	SY3000
N7	One-touch fitting for ø $\frac{1}{4}$ "	
M	Mixed	SY5000
N3	One-touch fitting for ø $\frac{5}{32}$ "	
N7	One-touch fitting for ø $\frac{1}{4}$ "	
N9	One-touch fitting for ø $\frac{9}{16}$ "	
M	Mixed	

* In the case of mixed specifications, indicate separately on the manifold specification sheet.

CE-compliant

Nil	—
Q	CE-compliant

Note) AC-type models that are CE-compliant have DIN terminals only.

How to Order Manifold Assembly (Example)

Example

Single solenoid (external pilot specifications)
SY3140R-5G (5 sets)

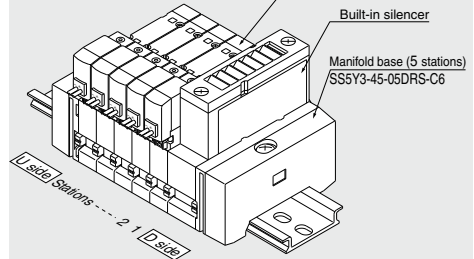

SS5Y3-45-05DRS-C6... 1 set (External pilot specification with built-in silencer part no.)

* SY3140R-5G 5 sets (Single solenoid part no.)

The asterisk denotes the symbol for assembly. Prefix it to the part nos. of the solenoid valve, etc.

The valve arrangement is numbered as the 1st. station from D side regardless of the mounting position of SUP/EXH block assembly. In ordering, specify the part nos. in the order from the 1st. station on D side. Besides, when the arrangement will be complicated, fill out the manifold specification sheet to instruct us.

For manifolds with SUP/EXH block assembly at each end of the manifold, external pilot ports and silencers will be also located at each end of the manifold. The SUP/EXH block assembly (SX3/5000-51-1A), for special specifications as shown on page 546, can also be mounted. Please specify the mounting position, by correctly filling in the blank space on the manifold specification sheet.



Note) AC-type models that are CE-compliant have DIN terminals only.

[Option]

How to Order Valve

SY **5** **2** **40** **□** **□** - **5** **L** **□** **□** - **□** **□**

Series

3	SY3000
5	SY5000

Type of actuation

1	2 position single
2	2 position double
3	3 position closed center
4	3 position exhaust center
5	3 position pressure center

Pilot type

NII	Internal pilot
R	External pilot

Coil specifications

NII	Standard
T	With power saving circuit (24 VDC, 12 VDC only)

* Power saving circuit is not available in the case of D, Y, DO, YO or W□ type.

Rated voltage

For DC

5	24 VDC
6	12 VDC
V	6 VDC
S	5 VDC
R	3 VDC

For AC (%Hz)

1	100 VAC
2	200 VAC
3	110 VAC [115 VAC]
4	220 VAC [230 VAC]

* DC specifications of Type D, Y, DO and YO is only available with 12 and 24 VDC.

* For type W□, DC voltage is only available.

* D, Y, DO and YO only available for SY5000.

Note) AC-type models that are CE-compliant have DIN terminals only.

CE-compliant

NII	—
Q	CE-compliant

Note) AC-type models that are CE-compliant have DIN terminals only.

Made to Order

NII	—
X90	Main valve fluororubber (Refer to page 624.)

Manual override

NII	Non-locking push type
D	Push-turn locking slotted type
E	Push-turn locking lever type

Light/Surge voltage suppressor

Electrical entry for G, H, L, M, W

NII	Without light/surge voltage suppressor
S	With surge voltage suppressor
Z	With light/surge voltage suppressor
R	With surge voltage suppressor (Non-polar type)
U	With light/surge voltage suppressor (Non-polar type)

* For AC voltage valves there is no "S" option. It is already built-in to the rectifier circuit.

* For "R" and "U", DC voltage is only available.

* Power saving circuit is only available in the "Z" type.

Electrical entry for D, Y (SY5000 only)

NII	Without light/surge voltage suppressor
S	With surge voltage suppressor (Non-polar type)
Z	With light/surge voltage suppressor (Non-polar type)

* DOZ and YOZ are not available.

* For AC voltage valves there is no "S" option. It is already built-in to the rectifier circuit.

Electrical entry

	24, 12, 6, 5, 3 VDC 100, 110, 200, 220 VAC	24, 12 VDC 100, 110, 200, 220 VAC	24, 12 VDC 6, 5, 3 VDC
	Grommet	L plug connector	M plug connector
G:	Lead wire length 300 mm	L: With lead wire (Length 300 mm)	M: With lead wire (Length 300 mm)
H:	Lead wire length 600 mm	LN: Without lead wire LO: Without connector	MN: Without lead wire MO: Without connector
			DIN terminal
			M8 connector
			(SY5000 only) D: With connector DO: Without connector Y: With connector YO: Without connector
			W□: Without connector cable W□: With connector cable Note)
CE-compliant	DC ● AC —	DC ● AC —	DC ● AC ●

* LN, MN type: with 2 sockets.

* D, Y, DO and YO only available for SY5000.

* "Y" type is a DIN terminal conforming to EN-175301-803C (former DIN43650C). Refer to page 638 for details.

* Setting "5LOU" is available only for connector box type.

* Refer to page 641 for connector cable of M8 connector.

* M8 connector conforming to IEC60947-5-2 standard is also available. Refer to page 623 for details.

* Refer to page 638 for the lead wire length of L and M plug connectors.

* Refer to page 639 for the connector assembly with cover for L and M plug connectors.

Note) Enter the cable length symbols in □. Please be sure to fill in the blank referring to page 642.

* When ordering single unit of the base mounted type solenoid valve, the mounting screws and gaskets for the integrated manifold are supplied with the solenoid valve, but the stacking type gaskets are not included. When the stacking type gaskets are required, order them separately.



Type 45 SY3000/5000

The SSSY3/5-45/T1□ type plug-in terminal block manifold is to be discontinued as of December 2019. Therefore, we recommend considering the SY3000/5000/7000 plug-in connector connecting base terminal block box type manifold as a substitute. [Click here](#) for details.) However, keep in mind that there is no specification or mounting compatibility between the two products.



Plug-in

How to Order Manifold

Type 45



Series

3	SY3000
5	SY5000

Common specifications

Nil	Positive common
N	Negative common

* No symbol is used for T, T1, S□ types.

Connector type

Symbol	Mounting position
F	D-sub connector
P	Flat ribbon cable 26 pins
PG	Flat ribbon cable 20 pins
PH	Flat ribbon cable 10 pins
T	Terminal block 9 pins
T1	Terminal block 18 pins
S□	Serial Transmission Type

* For details, refer to pages from 564.

Connector mounting position

Symbol	Mounting position
U	U side
D	D side

Valve stations

Symbol	Stations	Note
02	2 stations	Single wiring spec.
⋮	⋮	
20	20 stations	

- * This also includes the number of blanking plate assemblies.
- * Depending on the connector, the number of stations is limited. Refer to page 567.
- * Two stations are necessary for the double, 3 position (Dual body type).

SUP/EXH block assembly mounting position

Symbol	Mounting position	Stations
U	U side	2 to 10 stations
D	D side	2 to 10 stations
B	Both sides	2 to 20 stations
M	Special specifications	

* For special specifications, indicate separately by the manifold specification sheet.

SUP/EXH block assembly specifications

Symbol	Specifications
R	External pilot specifications
S	Internal pilot/Built-in silencer
RS	External pilot/Built-in silencer

A, B port size

One-touch fitting (Metric size)		One-touch fitting (Inch size)	
Symbol	Port size	Symbol	Port size
C4	One-touch fitting for ø4	N3	One-touch fitting for ø5/32"
C6	One-touch fitting for ø6	N7	One-touch fitting for ø1/4"
M	Mixed	M	Mixed
C4	One-touch fitting for ø4	N3	One-touch fitting for ø5/32"
C6	One-touch fitting for ø6	N7	One-touch fitting for ø1/4"
C8	One-touch fitting for ø8	N9	One-touch fitting for ø3/16"
M	Mixed	M	Mixed

* In the case of mixed specifications, indicate separately on the manifold specification sheet.

Voltage

Nil	24 VDC
12V	12 VDC

Option

When a longer DIN rail is desired than the specified stations, specify the station number to be required. (20 stations at maximum)

* No symbol is used for T, T1, S□ types.

CE-compliant

Nil	—
Q	CE-compliant

How to Order Manifold Assembly (Example)

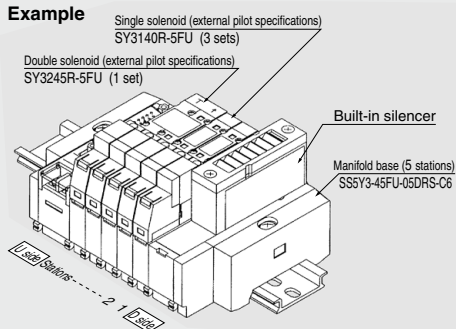

SSSY3-45FU-05DRS-C6...1 set (External pilot specification with built-in silencer part no.)

- * SY3140R-5FU.....3 sets (Single solenoid part no.)
- * SY3245R-5FU.....1 set (Double solenoid part no.)

The asterisk denotes the symbol for assembly. Prefix it to the part nos. of the solenoid valve, etc.

The valve arrangement is numbered as the 1st. station from D side regardless of the mounting position of SUP/EXH block assembly. In ordering, specify the part nos. in the order from the 1st. station on D side. Besides, when the arrangement will be complicated, fill out the manifold specification sheet to instruct us. For manifolds with SUP/EXH block at each end of the manifold, external pilot ports and silencers will be also located at each end of the manifold. The SUP/EXH block assembly (SX3/5000-51-1A), for special specifications, can also be mounted. Please specify the mounting position, by correctly filling in the blank space on the manifold specification sheet. Two stations of the manifold base are necessary for the double, 3 position (Dual body type). Use caution when specifying the number of stations required for the manifold base.

How to Order Valve



Series

3	SY3000
5	SY5000

Type of actuation

1	2 position single
2	2 position double
3	3 position closed center
4	3 position exhaust center
5	3 position pressure center

Body Option

0	Standard (Single only)
5	Dual body type (Double, 3 position)

Pilot type

Nil	Internal pilot
R	External pilot

Rated voltage

5	24 VDC
6	12 VDC
V	6 VDC
S	5 VDC
R	3 VDC

Manual override

Nil	Non-locking push type
D	Push-turn locking slotted type
E	Push-turn locking lever type

* Mark: 45T and T1 only
S□ type is available for 24 VDC only.

Made to Order

Nil	—	CE-compliant
X90	Main valve fluororubber (Refer to page 624.)	Nil
		Q

External Pilot/Built-in Silencer

[]: AC

SY3000: SS5Y3-45-Stations DRS-^{C4, N3}_{C6, N7}

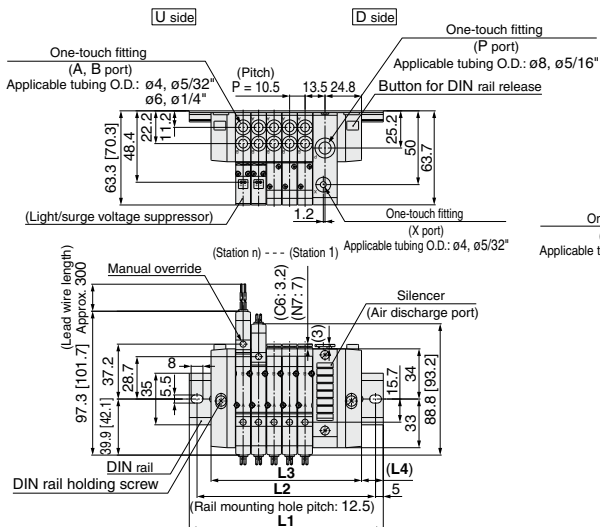

SS5Y3-45-Stations DR-^{C4, N3}_{C6, N7}

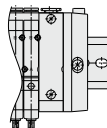
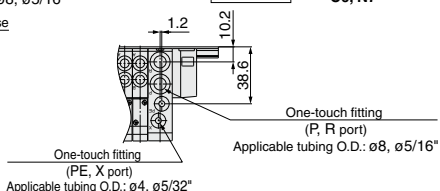

* The dimensions L1 to L4 are identical to those of **SS5Y3-45-Stations** U^{C4, N3}_{B C6, N7}.

SY5000: SS5Y5-45-Stations DRS-^{C4, N3}_{C6, N7}
^{C8, N9}

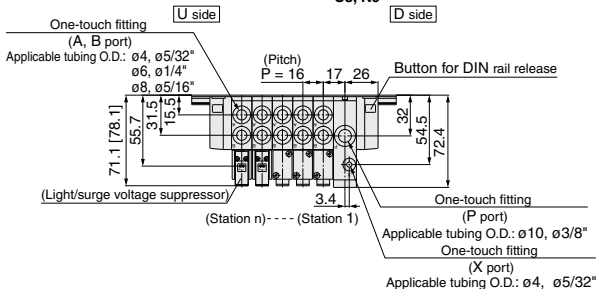

SS5Y5-45-Stations DR-^{C4, N3}_{C6, N7}
^{C8, N9}

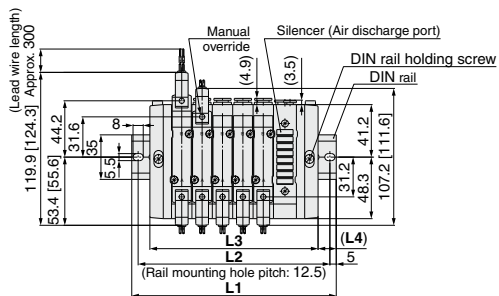
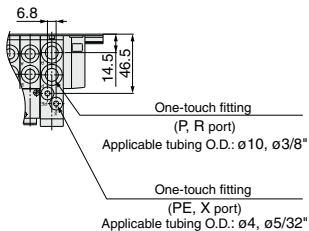

* The dimensions L1 to L4 are identical to those of **SS5Y3-45-Stations** U^{C4, N3}_{B C6, N7}.

* The dimensions of **SS5Y3-45-Stations** URS are identical to those of **SS5Y3-45-Stations** DRS.

External Pilot/Built-in Silencer

**SY3000: SS5Y3-45FU - Stations DRS-C4,N3
C6,N7**

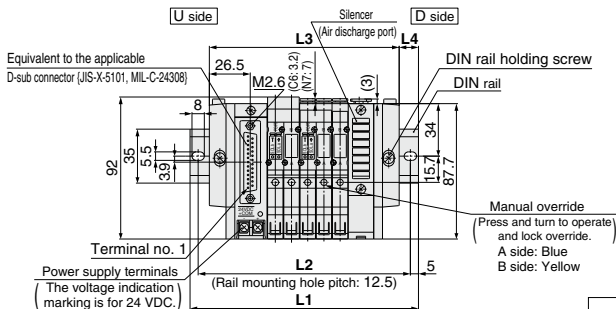
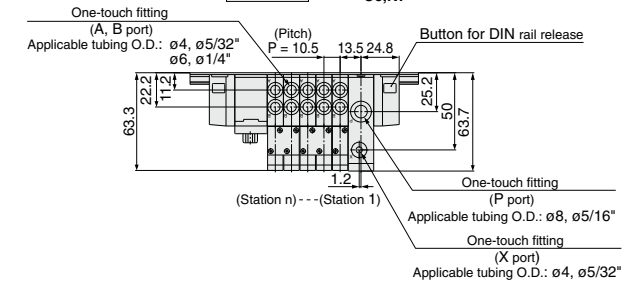

**SY5000: SS5Y5-45FU - Stations DRS-C4,N3
C6,N7
C8,N9**

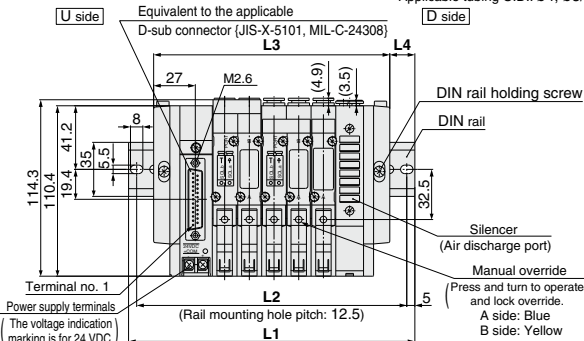
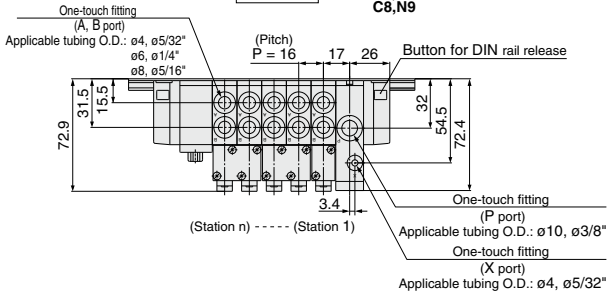

**SS5Y3-45FU - Stations DR-C4,N3
C6,N7**

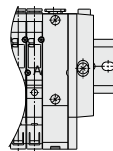
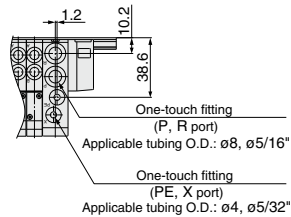

* The dimensions L1 to L4 are identical to those of SS5Y3-45FU - Stations D-C4,N3 C6,N7.

**SS5Y5-45FU - Stations DR-C4,N3
C6,N7
C8,N9**

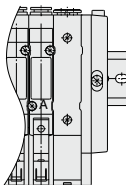
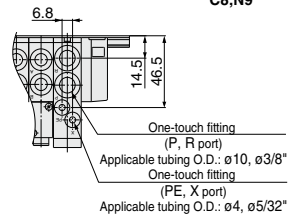

* The dimensions L1 to L4 are identical to those of SS5Y5-45FU - Stations D-C4,N3 C6,N7 C8,N9.

* The dimensions of SS5Y3-45 - Stations URS are identical to those of SS5Y3-45 - Stations DRS.

SY3000/5000

Made to Order

Mixed Mounting Type

Type M45



[Option]
Note) CE-compliant:
For DC only.

Non plug-in

This manifold makes it possible to mount SY3000 onto base of SY5000.

How to Order Manifold

Type M45 (Mixed mounting type)

SS5Y5-M45-05 U C86

• Mixed mounting type

• Valve stations SUP/EXH block assembly mounting position

Symbol	Stations	Symbol/Mounting position	Stations
02	2 stations	U	U side
:	:	D	D side
20	20 stations	B	Both sides
		M	Special specifications

* The number of blanking plate assembly is included, too.

* For special specifications, indicate separately by the manifold specification sheet.

SUP/EXH block assembly specifications

Symbol	Specifications
NII	Standard/Internal pilot specifications
S	Built-in silencer

* External pilot specification is unavailable for mixed mounting type.

• CE-compliant

NII	—
Q	CE-compliant

• Option

When a longer DIN rail is desired than the specified stations, specify the station number to be required. (Max. 20 stations)

A, B port size

One-touch fitting (Metric size)

Symbol	Port size
C44	SY5000: One-touch fitting for ø4 SY3000: One-touch fitting for ø4
C46	SY5000: One-touch fitting for ø4 SY3000: One-touch fitting for ø6
C64	SY5000: One-touch fitting for ø6 SY3000: One-touch fitting for ø4
C66	SY5000: One-touch fitting for ø6 SY3000: One-touch fitting for ø6
C84	SY5000: One-touch fitting for ø8 SY3000: One-touch fitting for ø8
C86	SY5000: One-touch fitting for ø8 SY3000: One-touch fitting for ø6
M	Mixed

* In the case of mixed specifications, indicate separately on the manifold specification sheet.

One-touch fitting (Inch size)

Symbol	Port size
N33	SY5000: One-touch fitting for ø $\frac{5}{16}$ " SY3000: One-touch fitting for ø $\frac{5}{16}$ "
N37	SY5000: One-touch fitting for ø $\frac{3}{8}$ " SY3000: One-touch fitting for ø $\frac{1}{4}$ "
N73	SY5000: One-touch fitting for ø $\frac{1}{4}$ " SY3000: One-touch fitting for ø $\frac{3}{8}$ "
N77	SY5000: One-touch fitting for ø $\frac{1}{4}$ " SY3000: One-touch fitting for ø $\frac{1}{4}$ "
N93	SY5000: One-touch fitting for ø $\frac{3}{8}$ " SY3000: One-touch fitting for ø $\frac{3}{8}$ "
N97	SY5000: One-touch fitting for ø $\frac{1}{2}$ " SY3000: One-touch fitting for ø $\frac{1}{4}$ "
M	Mixed

How to Order Manifold Assembly (Example)

Example

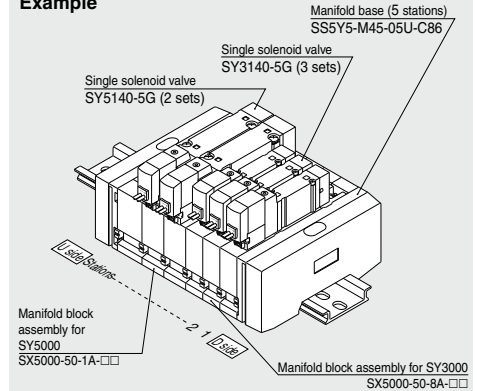

SS5Y5-M45-05U-C86 1 set (Type M45, manifold base part no.)
 * **SY3140-5G**..... 3 sets (Single solenoid part no.)
 * **SY5140-5G**..... 2 sets (Single solenoid part no.)

— The asterisk denotes the symbol for assembly.
 Prefix it to the part nos. of the solenoid valve, etc.

The valve arrangement is numbered as the 1st. station from D side regardless of the mounting position of SUP/EXH block assembly. In ordering, specify the part nos. in the order from the 1st. station on D side. Besides, when the arrangement will be complicated, fill out the manifold specification sheet to instruct us.

How to Order Valve

SY 5 2 40

Series

3	SY3000
5	SY5000

Type of actuation

1	2 position single
2	2 position double
3	3 position closed center
4	3 position exhaust center
5	3 position pressure center

• Coil specifications

T	Standard
NII	With power saving circuit (24 VDC, 12 VDC only)

* Power saving circuit is not available in the case of WJ type.

Rated voltage

For DC	CE-compliant	For AC (V/Hz)	CE-compliant
5	24 VDC	1	100 VAC
6	12 VDC	2	200 VAC
V	6 VDC	3	110 VAC [115 VAC]
S	5 VDC	4	220 VAC [230 VAC]
R	3 VDC		

* For type W□, DC voltage is only available.
 Note) CE-compliant: For DC only.

* When ordering single unit of the base mounted type solenoid valve, the mounting screws and gaskets for the integrated manifold are supplied with the solenoid valve, but the stacking type gaskets are not included. When the stacking type gaskets are required, order them separately.

• Electrical entry for G, H, L, M, W

NII	Without light/surge voltage suppressor
S	With surge voltage suppressor
Z	With light/surge voltage suppressor
R	With surge voltage suppressor (Non-polar type)
U	With light/surge voltage suppressor (Non-polar type)

* For AC voltage valves there is no "S" option. It is already built-in to the rectifier circuit.
 * For "R" and "U", DC voltage is only available.
 * Power saving circuit is only available in the "Z" type.

• Electrical entry

24, 12, 6, 5, 3 VDC/100, 110, 200, 220 VAC				24, 12, 6, 5, 3 VDC
Grommet	L plug connector	M plug connector	M8 connector	
G: Lead wire length 300 mm	L: With lead wire (Length 300 mm)	M: With lead wire (Length 300 mm)	WO: Without connector cable	
H: Lead wire length 600 mm	LN: Without lead wire	MN: Without lead wire	W□: With connector cable (Note)	
	LO: Without connector	MO: Without connector		

* LN, MN type: with 2 sockets.

* Refer to page 641 for connector cable of M8 connector.

* M8 connector conforming to IEC60947-5-2 standard is also available. Refer to page 623 for details.

* Refer to page 638 for the lead wire length of L and M plug connectors.

* Refer to page 639 for the connector assembly with cover for L and M plug connectors.

Note) Enter the cable length symbols in □. Please be sure to fill in the blank referring to page 642.

SJ

SY

SY

S0700

S0700

Dimensions: Mixed Mounting

[] : AC

SS5Y5-M45- Stations U

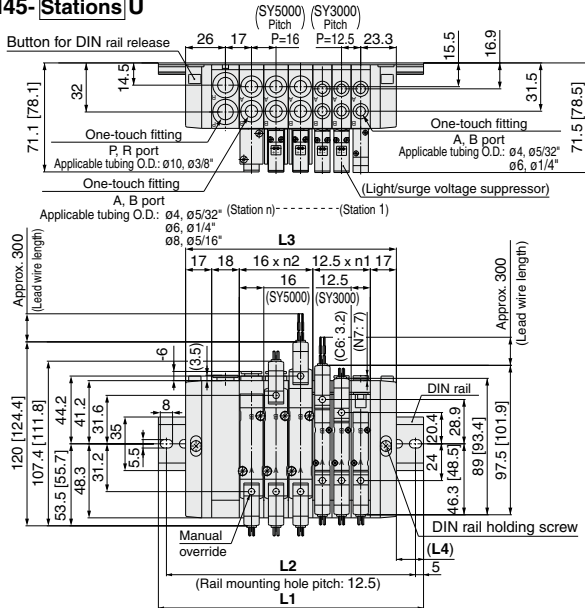

L dimension: Formulae for L1 to L4
 $L3 = 12.5 \times n1 + 16 \times n2 + 52$
 $M = \left(\frac{L3}{12.5} + 1 \right)$ Omit decimals
 $L1 = 12.5 \times M + 23$
 $L2 = L1 - 10.5$
 $L4 = (L1 - L3) / 2$

n1 = Number of SY3000
 n2 = Number of SY5000

(Note) The L1 to L4 dimensions of **SS5Y5-M45- Stations D** are identical to those of **SS5Y5-M45- Stations U**.

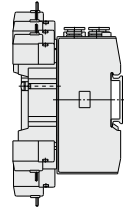

SS5Y5-M45- Stations B

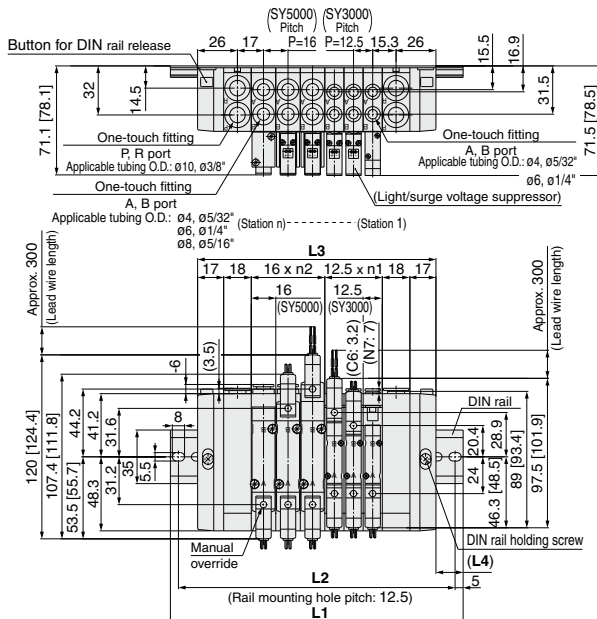

L dimension: Formulae for L1 to L4
 $L3 = 12.5 \times n1 + 16 \times n2 + 70$
 $M = \left(\frac{L3}{12.5} + 1 \right)$ Omit decimals
 $L1 = 12.5 \times M + 23$
 $L2 = L1 - 10.5$
 $L4 = (L1 - L3) / 2$

n1 = Number of SY3000
 n2 = Number of SY5000

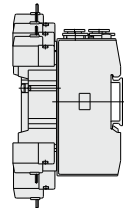

[SY3000/5000/7000/9000/SY300/500 Series]

Made to Order

M8 Connector Conforming to IEC60947-5-2



How to Order Valve

* For details on specifications, refer to page 637.

Type of actuation

3	Body ported
5	Base mounted

Type of actuation

1	Normally closed
2	Normally open

Series

3	SY300
5	SY500

3 port valve (5 port valve mixed mounting type)

SY 3 1 3

5 port valve

SY 3 2 2 0

Series

3	SY3000
5	SY5000
7	SY7000
9	SY9000

Type of actuation

1	2 position single
2	2 position double
3	3 position closed center
4	3 position exhaust center
5	3 position pressure center

Body type

2	Body ported
4	Base mounted
6	Body ported cassette type

* The body ported cassette type is not available for the SY9000 series.

Note) When placing an order for body ported solenoid valve as a single unit, gaskets are not included. Order them separately, if necessary. (Refer to catalog on page 467 for details.)

A port size Thread piping

Symbol	Port size	Applicable series
Nll	Base mounted	
M5	M5 x 0.8	SY300
01	1/8	SY500

One-touch fitting (Metric size)

Symbol	Port size	Applicable series
C4	One-touch fitting for ø4	SY300
C6	One-touch fitting for ø6	
C4	One-touch fitting for ø4	SY500
C6	One-touch fitting for ø6	
C8	One-touch fitting for ø8	

One-touch fitting (Inch size)

Symbol	Port size	Applicable series
N3	One-touch fitting for 5/32	SY300
N7	One-touch fitting for 1/4	SY300
N7	One-touch fitting for 1/4	SY500
N9	One-touch fitting for 3/16	

Thread type

Nll	Rc
F	G
N	NPT
T	NPTF

CE-compliant

Nll	—
Q	CE-compliant

Electrical entry

WAO: Without connector cable

WA□: With connector cable (Note 1)

Note 1) □: Enter a symbol for cable length. Enter referring page 642.

Rated voltage

For DC

5	24 VDC
6	12 VDC
V	6 VDC
S	5 VDC
R	3 VDC

Light/Surge voltage suppressor

Nll	Without light/surge voltage suppressor
S	With surge voltage suppressor
Z	With indicator light and surge voltage suppressor
R	Without surge voltage suppressor (non-polar type)
U	Without light/surge voltage suppressor (non-polar type)

Manual override

Nll	Non-locking push type
D	Push-turn locking slotted type
E	Push-turn locking lever type

Made to Order

Nll	—
X20	Body ported external pilot (Refer to page 624.)
X90	Main valve fluororubber (Refer to page 624.)

* X20 for the SY9000 series is not available.
* X20 for the base mounted type is not available.

A, B port size Thread piping

Symbol	Port size	Applicable series
M5	M5 x 0.8	SY3000
01	1/8	SY5000
02	1/4	SY7000
02	1/4	
03	3/8	SY9000

One-touch fitting (Metric size)

Symbol	Port size	Applicable series
C4	One-touch fitting for ø4	SY3000
C6	One-touch fitting for ø6	
C4	One-touch fitting for ø4	SY5000
C6	One-touch fitting for ø6	
C8	One-touch fitting for ø8	
C8	One-touch fitting for ø8	SY7000
C10	One-touch fitting for ø10	
C8	One-touch fitting for ø8	SY9000
C10	One-touch fitting for ø10	
C12	One-touch fitting for ø12	

One-touch fitting (Inch size)

Symbol	Port size	Applicable series
N3	One-touch fitting for ø5/32	SY3000
N7	One-touch fitting for ø1/4	
N3	One-touch fitting for ø5/32	SY5000
N7	One-touch fitting for ø1/4	
N9	One-touch fitting for ø3/16	
N9	One-touch fitting for ø3/16	SY7000
N11	One-touch fitting for ø3/8	
N9	One-touch fitting for ø3/16	SY9000
N11	One-touch fitting for ø3/8	

For Base Mounted

Symbol	Port size	Applicable series
Nll	Without sub-plate	—
01	With sub-plate	SY3000
02	With sub-plate	SY5000
02	With sub-plate	SY7000
03	With sub-plate	SY7000
03	With sub-plate	SY9000
04	With sub-plate	SY9000

SJ
SY
SY
S0700
S0700

How to Order Pilot Valve

V111- 5 WAO □

Rated voltage

For DC

5	24 VDC
6	12 VDC
V	6 VDC
S	5 VDC
R	3 VDC

Light/Surge voltage suppressor

Nll	Without light/surge voltage suppressor
S	With surge voltage suppressor
Z	With indicator light and surge voltage suppressor
R	With surge voltage suppressor (non-polar type)
U	Without light/surge voltage suppressor (non-polar type)

Electrical entry

WAO	M8	Without connector cable
WA□	connector	With connector cable (Note 1)

Note 1) □: Enter a symbol for cable length. Enter referring page 642.

* Since V111 is CE-compliant as standard, the suffix "Q" is not necessary.



SY3000/5000/7000/9000 Series

Made to Order

Body Ported External Pilot/Fluororubber for Main Valve



Body Ported External Pilot

Applicable solenoid valves: SY3□□0, SY5□□0, SY7□□0 series



Entry is the same as standard products.

Note) Din terminal is not available for the SY3000 series.

CE-compliant

Nil	—
Q	CE-compliant

Note) AC-type models that are CE-compliant have DIN terminals only.

Operating pressure range MPa

Operating pressure range	-100 kPa to 0.7
Pilot pressure range	0.25 to 0.7

External pilot port

Series	Port size
SY3000	M3 x 0.5
SY7000	M5 x 0.8

Dimensions

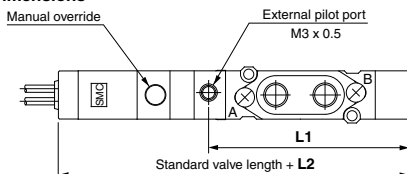

Dimensions/External Pilot Port Position

Series	L1 dimensions	L2 dimensions
SY3000	41.5	6.5
SY5000	60.4	9
SY7000	71.9	9

Symbol

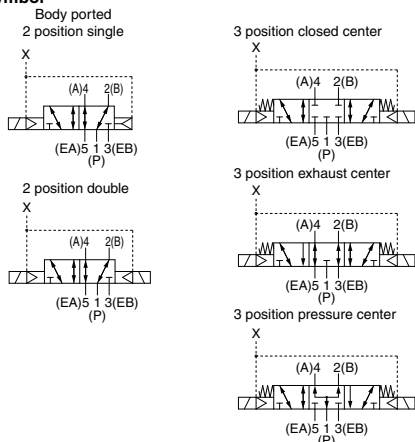

Main Valve Fluororubber Specifications

Fluororubber is used for rubber parts of the main valve to allow use in applications such as the following.

- When using a lubricant other than the recommended turbine oil, and there is a possibility of malfunction due to swelling of the spool valve seals.

Applicable solenoid valves: SY3□□0, SY5□□0, SY7□□0, SY9□□0 series



Entry is the same as standard products.

Specifications and performance are the same as standard products.

CE-compliant

Nil	—
Q	CE-compliant

Note) AC-type models that are CE-compliant have DIN terminals only.

SY5000

Made to Order

Body Ported Vacuum Release Valve with Throttle Valve



Vacuum Release Valve with Throttle Valve: SY5A2R

- Line for vacuum adsorption transfer
- Built-in throttle valve in the vacuum release valve
- Can be mounted on the SS5Y5-20-type (Individual wiring type) and SS5Y5-20P-type (Flat ribbon cable type) Manifold
- Valve effective area

Symbol

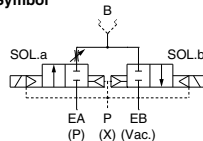

B port Port size <small>Note 1)</small>	Effective area: mm ²	
	EA→B <small>Note 2)</small>	B→EB
C6	4.4	6.8
C8	4.5	7.0

Note 1) Refer to the part numbers for the port size.
Note 2) When the built-in throttle valve is fully open.

Specifications

Valve type	External pilot type, Dual 2 port solenoid valve	
Type of actuation	Normally closed (N.C. valve)	
Fluid	Air	
Operating pressure range	P (External pilot pressure)	0.15 to 0.7 MPa
	EA (Vacuum release pressure)	0 to 0.7 MPa
	EB (Vacuum)	-100 kPa to 0 MPa
Pilot valve exhaust method	Pilot valve individual exhaust	
Ambient and fluid temperature	-10 to 50°C (No condensation)	

Effective Area/Weight

B port Port size <small>Note 1)</small>	Effective area: mm ²		Weight (g)
	EA→B <small>Note 2)</small>	B→EB	
C6	4.4	6.8	94
C8	4.5	7.0	88

Note 1) Refer to the part numbers for the port size.
Note 2) When the built-in throttle valve is fully open.

How to Order

Single unit: External pilot type dual 2 port solenoid valve

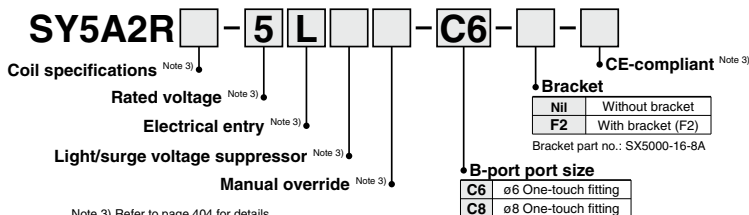

Manifold: Body ported bar stock (20/20P/20SA type)

* Specify the part numbers for valves and options together beneath the manifold base part number in order starting from the first station.

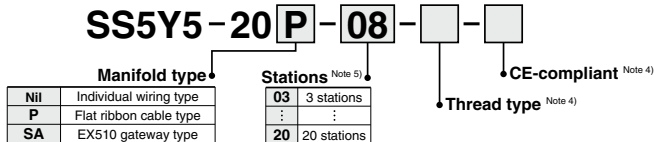

Note 4) Refer to pages 438 and 448 for details.
Note 5) 20P (Flat ribbon cable type): Max. 12 stations

Example

SS5Y5-20-05 1 set

*SY5A2R-5LOU-C6... 5 sets

↳ The asterisk denotes the symbol for assembly. Prefix it to the part nos. of the solenoid valve, etc.

SY5000

Dimensions/Single Unit: SY5A2R

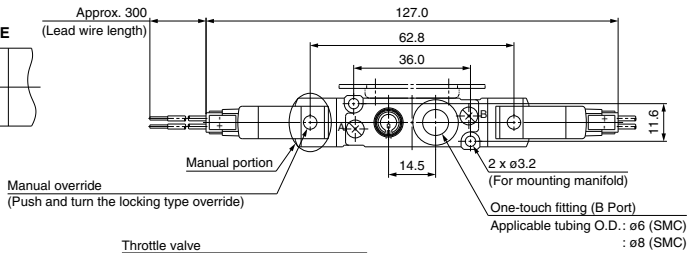
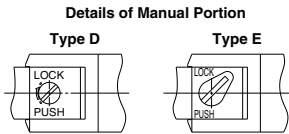
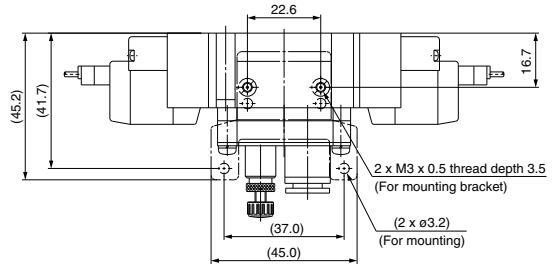

Light/surge voltage suppressor

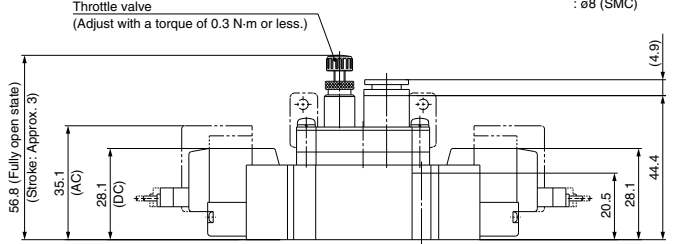
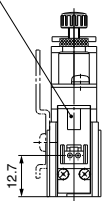

Symbol

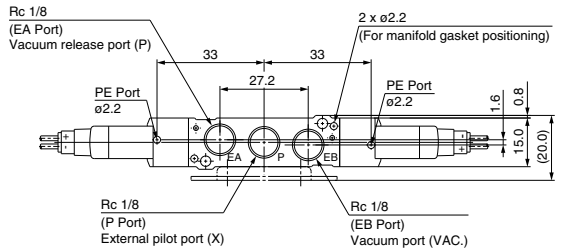
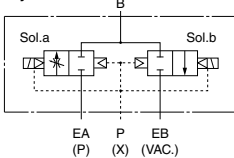

[Remarks for valves]

- Note 1) Refer to pages 450, 636 and 637 for the details of electrical entry and electrical circuit with a light/surge voltage suppressor.
- Note 2) Diagrams above are compatible with SY5A2R-□□□□□□□□□□(F2).
- Note 3) When mounted with brackets, the product is mounted in a place specified with one dot chain lines.
- Note 4) Applicable pilot valves are SY114/SY115-□□□□.

Dimensions/Manifold: SS5Y5-20P-

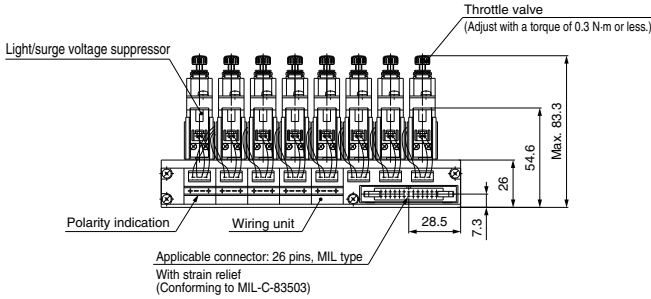
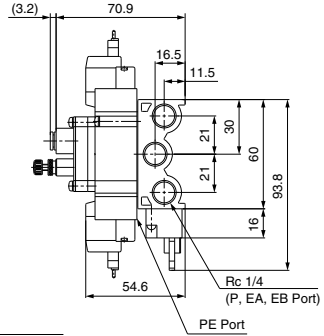
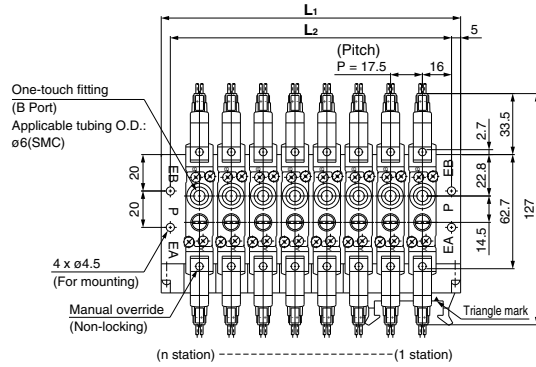

Pneumatic Circuit

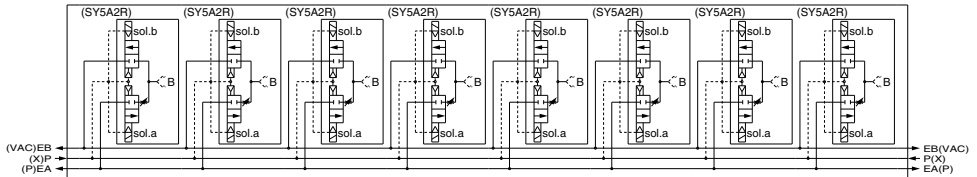

Schematic of Connector (Example: For this figure)

(Light/surge voltage suppressor is not included.)

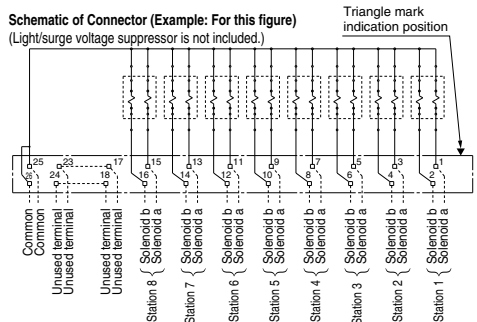

L: Dimensions: mm

n	3	4	5	6	7	8	9	10	11	12
L_1	77	94.5	112	129.5	147	164.5	182	199.5	217	234.5
L_2	67	84.5	102	119.5	137	154.5	172	189.5	207	224.5
 	03	04	05	06	07	08	09	10	11	12

* Applicable blanking plate assembly part no.:
 SS5Y5-20- : SY5000-26-20A (with screws and gaskets)
 SS5Y5-20P- : SY5000-26-21A (with screws, gaskets and dust cap)
 * The product cannot be mounted with standard products the SY5000/500 series on a manifold.

How to Use Manifold

⚠ Caution

<20/20P Type>

A piping port is different from that for the standard product. When not connected properly, the product will not operate properly.

[P port: External pilot port, EA port: Vacuum release pressure port, EB port: Vacuum suction port]

<20P Type>

1. If a large amount of drainage is included in the supply air, it may cause electrical trouble since a wiring unit is located in the place where exhaust from the PE port directly goes through. Be sure to control the supply air.
2. For more than 10 stations, both poles of the common should be wired.
3. When replacing a solenoid valve, etc., be sure to mount it by placing the solenoid a side on the connector (MIL type) side.
4. Terminal no. is not indicated on the connector.
5. The terminal no. indicated in the connection schematic of connector, as shown in the reference, means a correlation of 1, 2, 3...26 from the triangle mark side on the flat ribbon cable of connector. (Refer to the reference drawing.)

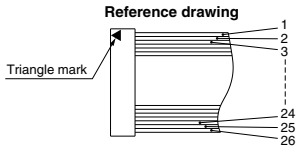

SY300/500 Series

Made to Order

Body Ported External Pilot/Fluororubber for Main Valve



Body Ported External Pilot

Applicable solenoid valves: SY3□3, SY5□3



• Entry is the same as standard products.

(Note) Din terminal is not available for the SY300 series.

NH	—
Q	CE-compliant

(Note) AC-type models that are CE-compliant have DIN terminals only.

Operating pressure range MPa

Operating pressure range	-100 kPa to 0.7
Pilot pressure range	0.25 to 0.7

External pilot port

Series	Port size
SY300	M3 x 0.5
SY500	M5 x 0.8

Dimensions

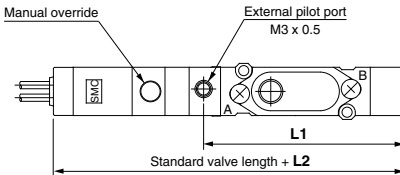

Dimensions/External Pilot Port Position

Series	L1 dimensions	L2 dimensions
SY300	41.5	6.5
SY500	60.4	9

Symbol

Body ported
Normally closed (N.C.)
Single solenoid

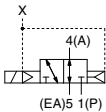

Normally closed (N.C.)
Double solenoid

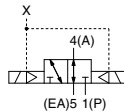

Normally open (N.O.)
Single solenoid

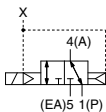

Normally open (N.O.)
Double solenoid

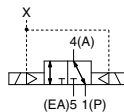

Main Valve Fluororubber Specifications

Fluororubber is used for rubber parts of the main valve to allow use in applications such as the following.

- When using a lubricant other than the recommended turbine oil, and there is a possibility of malfunction due to swelling of the spool valve seals.

Applicable solenoid valves: SY3□3, SY5□3

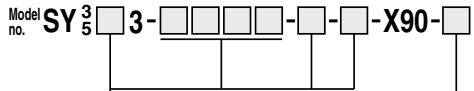

• Entry is the same as standard products.

Specifications and performance are the same as standard products.

NH	—
Q	CE-compliant

(Note) AC-type models that are CE-compliant have DIN terminals only.

SJ

SY

SY

S0700

S0700

SY3000/5000/7000/9000 Series Pilot Valve Assembly Port Block Assembly

How to Order Pilot Valve Assembly

V111 - 5 G

Coil specifications

Nil	Standard
T	With power saving circuit (24 VDC, 12 VDC only)

* Power saving circuit is not available in the case of D, DO or W□ type.

Rated voltage

5	24 VDC
6	12 VDC
V	6 VDC
S	5 VDC
R	3 VDC
1	100 VAC $\frac{50}{60}$ Hz
2	200 VAC $\frac{50}{60}$ Hz
3	110 VAC $\frac{50}{60}$ Hz [115 VAC $\frac{50}{60}$ Hz]
4	220 VAC $\frac{50}{60}$ Hz [230 VAC $\frac{50}{60}$ Hz]

* For type W□, DC voltage is only available.

* CE-compliant: For DC only.

Light/Surge voltage suppressor

Nil	Without light/surge voltage suppressor
S	With surge voltage suppressor
Z	With light/surge voltage suppressor
R	With surge voltage suppressor (Non-polar type)
U	With light/surge voltage suppressor (Non-polar type)

* For AC voltage valves there is no "S" option. It is already built-in to the rectifier circuit.
* For "R" and "U", DC voltage is only available.
* Power saving circuit is only available in the "Z" type.

Electrical entry

G	Grommet, 300 mm lead wire
H	Grommet, 600 mm lead wire
L	With lead wire
LN	Without lead wire
LO	Without connector
M	With lead wire
MN	Without lead wire
MO	Without connector
WO	Without connector cable
W□	With connector cable <small>Note 1)</small>

* For connector cable of M8 connector, refer to page 641.
Note 1) Enter the cable length symbols in . Please be sure to fill in the blank referring to page 642.

DIN terminal type

V115 - 5 D

Rated voltage

5	24 VDC
6	12 VDC
1	100 VAC $\frac{50}{60}$ Hz
2	200 VAC $\frac{50}{60}$ Hz
3	110 VAC $\frac{50}{60}$ Hz [115 VAC $\frac{50}{60}$ Hz]
4	220 VAC $\frac{50}{60}$ Hz [230 VAC $\frac{50}{60}$ Hz]

* DC specifications of type D and DO is only available with 12 and 24 VDC.

Light/Surge voltage suppressor

Nil	Without light/surge voltage suppressor
S	With surge voltage suppressor (Non-polar type)
Z	With light/surge voltage suppressor (Non-polar type)

* DOZ and YOZ are not available.
* For AC voltage valves there is no "S" option. It is already built-in to the rectifier circuit.

Electrical entry

D	DIN terminal	With connector
DO	terminal (Type D)	Without connector
Y	DIN terminal	With connector
YO	terminal (Type Y)	Without connector

Note) Do not replace V111 (G, H, L, M) to V115 (DIN terminal) and vice versa when replacing pilot valve assembly only.

How to Order Port Block Assembly

SY 000 - 6A -

Series

3	SY3000
5	SY5000
7	SY7000
9	SY9000

A, B port size

Thread piping

Symbol	Port size	Applicable series
M5	M5 x 0.8	SY3000
01	1/8	SY5000
02	1/4	SY7000
02	1/4	SY9000
03	3/8	SY9000

Thread type

Nil	Rc
F	G
N	NPT
T	NPTF

* Except for M5

One-touch fitting (Metric size)

Symbol	Port size	Applicable series
C4	One-touch fitting for ø4	SY3000
C6	One-touch fitting for ø6	SY3000
C4	One-touch fitting for ø4	SY5000
C6	One-touch fitting for ø6	SY5000
C8	One-touch fitting for ø8	SY5000
C8	One-touch fitting for ø8	SY7000
C10	One-touch fitting for ø10	SY7000
C8	One-touch fitting for ø8	SY9000
C10	One-touch fitting for ø10	SY9000
C12	One-touch fitting for ø12	SY9000

One-touch fitting (Inch size)

Symbol	Port size	Applicable series
N3	One-touch fitting for ø $\frac{5}{16}$ "	SY3000
N7	One-touch fitting for ø $\frac{1}{4}$ "	SY3000
N3	One-touch fitting for ø $\frac{5}{16}$ "	SY5000
N7	One-touch fitting for ø $\frac{1}{4}$ "	SY5000
N9	One-touch fitting for ø $\frac{3}{16}$ "	SY7000
N9	One-touch fitting for ø $\frac{5}{16}$ "	SY7000
N11	One-touch fitting for ø $\frac{3}{8}$ "	SY7000
N9	One-touch fitting for ø $\frac{3}{16}$ "	SY9000
N11	One-touch fitting for ø $\frac{3}{8}$ "	SY9000

How to Change Port Block Assembly

Connecting port size of A and B can be changed by replacing port block assembly mounted on body. When changing block assembly, correct screw torque must be achieved to avoid trouble; e.g. air leakage.

With the one-touch fitting port block assembly, it is only necessary to change the fitting and not the whole block. Refer to following part numbers.

One-touch fitting (Metric size)

Port size	Fitting assembly part no.	Applicable series
One-touch fitting for ø4	VVQ1000-50A-C4	SY3000
One-touch fitting for ø6	VVQ1000-50A-C6	SY3000
One-touch fitting for ø4	VVQ1000-51A-C4	SY5000
One-touch fitting for ø6	VVQ1000-51A-C6	SY5000
One-touch fitting for ø8	VVQ1000-51A-C8	SY5000
One-touch fitting for ø8	VVQ2000-51A-C8	SY7000
One-touch fitting for ø10	VVQ2000-51A-C10	SY7000
One-touch fitting for ø8	VVQ4000-50B-C8	SY9000
One-touch fitting for ø10	VVQ4000-50B-C10	SY9000
One-touch fitting for ø12	VVQ4000-50B-C12	SY9000

One-touch fitting (Inch size)

Port size	Fitting assembly part no.	Applicable series
One-touch fitting for ø $\frac{5}{32}$ "	VVQ1000-50A-N3	SY3000
One-touch fitting for ø $\frac{1}{4}$ "	VVQ1000-50A-N7	SY3000
One-touch fitting for ø $\frac{5}{32}$ "	VVQ1000-51A-N3	SY5000
One-touch fitting for ø $\frac{1}{4}$ "	VVQ1000-51A-N7	SY5000
One-touch fitting for ø $\frac{5}{16}$ "	VVQ1000-51A-N9	SY5000
One-touch fitting for ø $\frac{1}{4}$ "	VVQ2000-51A-N9	SY7000
One-touch fitting for ø $\frac{3}{8}$ "	VVQ2000-51A-N11	SY7000
One-touch fitting for ø $\frac{5}{16}$ "	VVQ4000-50B-N9	SY9000
One-touch fitting for ø $\frac{3}{8}$ "	VVQ4000-50B-N11	SY9000

Note) Purchasing order is available in units of 10 pieces.

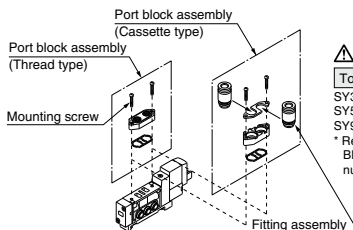

Caution

Torque for mounting screws

SY3000 (M2): 0.12N·m
SY5000/7000 (M3): 0.6 N·m
SY9000 (M4): 1.4N·m

* Refer to "How to Change Port Block Assembly" for part numbers.

Note) Since V111 and V115 are CE-compliant standard, the suffix "-Q" is not necessary.

5 Port Solenoid Valve Body Ported/Single Unit SY3000/5000/7000/9000 Series



How to Order

30 - SY 5 1 20 - 5 L - 01 - - - -

Series

3	SY3000
5	SY5000
7	SY7000
9	SY9000

Conforming to UL standard

Type of actuation

1	2 position single (A)4 2(B)	
	(EA)5 1 3(EB) (P)	
2	2 position double (A)4 2(B)	
	(EA)5 1 3(EB) (P)	
3	3 position closed center (A)4 2(B)	
	(EA)5 1 3(EB) (P)	
4	3 position exhaust center (A)4 2(B)	
	(EA)5 1 3(EB) (P)	
5	3 position pressure center (A)4 2(B)	
	(EA)5 1 3(EB) (P)	

Coil specifications

NII	Standard
T	With power saving circuit (24 VDC, 12 VDC only)

* Power saving circuit is not available in the case of D, Y, DO, YO or W□ type.

DC	
5	24 VDC
6	12 VDC
V	6 VDC
S	5 VDC
R	3 VDC

Rated voltage

AC (50/60Hz)	
B	24 VAC

* DC specifications of type D, Y, DO and YO is only available with 12 and 24 VDC.
* For type W□, DC voltage is only available.

Electrical entry

24, 12, 6, 5, 3 VDC/24 VAC				24, 12 VDC/24 VAC	
Grommet	L plug connector	M plug connector	MN: Without lead wire	D, Y: With connector	
G: Lead wire length 300 mm	L: With lead wire (Length 300 mm)	M: With lead wire (Length 300 mm)			
H: Lead wire length 600 mm	LN: Without lead wire	LO: Without connector	MO: Without connector	DO, YO: Without connector	

24, 12, 6, 5, 3 VDC

M8 connector	
WO: Without connector cable	WAO: Without connector cable
<p>W1: With connector cable (Length 0.3 m)</p> <p>W2: With connector cable (Length 0.5 m)</p> <p>W3: With connector cable (Length 1 m)</p> <p>W4: With connector cable (Length 2 m)</p> <p>W5: With connector cable (Length 3 m)</p> <p>W6: With connector cable (Length 4 m)</p> <p>W7: With connector cable (Length 5 m)</p>	<p>WA1: With connector cable (Length 0.3 m)</p> <p>WA2: With connector cable (Length 0.5 m)</p> <p>WA3: With connector cable (Length 1 m)</p> <p>WA4: With connector cable (Length 2 m)</p> <p>WA5: With connector cable (Length 3 m)</p> <p>WA6: With connector cable (Length 4 m)</p> <p>WA7: With connector cable (Length 5 m)</p>

* LN, MN type: with 2 sockets.
* For DIN terminal of SY3000 series, refer to page 639.
* "Y" type is a DIN terminal conforming to EN-175301-803C (former DIN43650C). For details, refer to page 638.
* For connector cable of M8 connector, refer to page 641.
* For the M8 connector with a connector cable, only American certification (UL) is available.
* Refer to page 638 for the lead wire length of L and M plug connectors.

A, B port size Thread piping

Symbol	Port size	Applicable series
M5	M5 x 0.8	SY3000
01	1/8	SY5000
02	1/4	SY7000
02	1/4	SY9000
03	3/8	SY9000

One-touch fitting (Metric size)

Symbol	Port size	Applicable series
C4	One-touch fitting for ø4	SY3000
C6	One-touch fitting for ø6	
C4	One-touch fitting for ø4	SY5000
C6	One-touch fitting for ø6	
C8	One-touch fitting for ø8	SY7000
C8	One-touch fitting for ø8	SY9000
C10	One-touch fitting for ø10	
C8	One-touch fitting for ø8	SY9000
C10	One-touch fitting for ø10	SY9000
C12	One-touch fitting for ø12	

One-touch fitting (Inch size)

Symbol	Port size	Applicable series
N3	One-touch fitting for ø 3/32	SY3000
N7	One-touch fitting for ø 1/4"	
N3	One-touch fitting for ø 3/32	SY5000
N7	One-touch fitting for ø 1/4"	
N9	One-touch fitting for ø 9/16"	SY7000
N9	One-touch fitting for ø 9/16"	SY9000
N11	One-touch fitting for ø 3/8"	
N9	One-touch fitting for ø 9/16"	SY9000
N11	One-touch fitting for ø 3/8"	

Bracket

NII: Without bracket
F1: With foot bracket

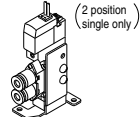

F2: With side bracket

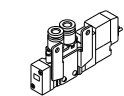

* SY9000 has no bracket.

Thread type

NII	Rc
F	G
N	NPT
T	NPTF

* Except for M5

Made to Order

NII	—
X20	Body ported external pilot (Refer to page 624.)
X90	Main valve fluoronubber (Refer to page 624.)

CE-compliant

NII	—
Q	CE-compliant

Manual override

NII: Non-locking push type	D: Push-turn locking slotted type	E: Push-turn locking lever type

Light/Surge voltage suppressor

Electrical entry for G, H, L, M, W		Electrical entry for D, Y	
NII	Without light/surge voltage suppressor	NII	Without light/surge voltage suppressor
S	With surge voltage suppressor	S	With surge voltage suppressor
Z	With light/surge voltage suppressor	Z	With light/surge voltage suppressor
R	With surge voltage suppressor (Non-polar type)	DO	Without light/surge voltage suppressor
U	With light/surge voltage suppressor (Non-polar type)	YOZ	Without light/surge voltage suppressor

* For AC voltage valves there is no "S" option. It is already built-in to the rectifier circuit.
* For "R" and "U", DC voltage is only available.
* Power saving circuit is only available in the "Z" type

Note) When placing an order for body ported solenoid valve as a single unit, mounting screw for manifold and gasket are not attached. Order them separately, if necessary. (For details, refer to page 467.)

Refer to the standard product for specifications and dimensions.

5 Port Solenoid Valve

Base Mounted/Single Unit

SY3000/5000/7000/9000 Series



How to Order

30-SY 5 2 40 [] [] - **5 L** [] [] [] [] [] [] [] []

Series

3	SY3000
5	SY5000
7	SY7000
9	SY9000

• Conforming to UL standard

Pilot type

NII	Internal pilot
R	External pilot

Coil specifications

NII	Standard
T	With power saving circuit (24 VDC, 12 VDC only)

* Power saving circuit is not available in the case of D, Y, DO, YO or WC type.

Rated voltage

DC	AC (50/60 Hz)	
5	24 VDC	
6	12 VDC	
V	6 VDC	
S	5 VDC	
R	3 VDC	
	B	24 VAC

* DC specifications of type D, Y, DO and YO is only available with 12 and 24 VDC.
* For type WC, DC voltage is only available.

Port size

Symbol	Port size	Applicable series
NII	Without sub-plate	
01	1/8" With sub-plate	SY3000
02	1/4" With sub-plate	SY5000 SY7000
03	3/8" With sub-plate	SY7000 SY9000
04	1/2" With sub-plate	SY9000

• CE-compliant

NII	—
Q	CE-compliant

• Made to Order

NII	—
X90	Main valve fluororubber (Refer to page 624.)

• Thread type

NII	Rc
F	G
N	NPT
T	NPTF

Manual override

NII: Non-locking push type

D: Push-turn locking slotted type

E: Push-turn locking lever type

• Light/Surge voltage suppressor

Electrical entry for G, H, L, M, W

NII	Without light/surge voltage suppressor
S	With surge voltage suppressor
Z	With light/surge voltage suppressor
R	With surge voltage suppressor (Non-polar type)
U	With light/surge voltage suppressor (Non-polar type)

* For AC voltage valves there is no "S" option. It is already built-in to the rectifier circuit.
* For "R" and "U", DC voltage is only available.
* Power saving circuit is only available in the "Z" type

Electrical entry for D, Y

NII	Without light/surge voltage suppressor
S	With surge voltage suppressor
Z	With light/surge voltage suppressor

* DOZ and YOZ are not available.
* For AC voltage valves there is no "S" option. It is already built-in to the rectifier circuit.

Type of actuation

1	2 position single (A)4 2(B) (EA)5 1 3(EB) (P)
2	2 position double (A)4 2(B) (EA)5 1 3(EB) (P)
3	3 position closed center (A)4 2(B) (EA)5 1 3(EB) (P)
4	3 position exhaust center (A)4 2(B) (EA)5 1 3(EB) (P)
5	3 position pressure center (A)4 2(B) (EA)5 1 3(EB) (P)

Electrical entry

	24, 12, 6, 5, 3 VDC/24 VAC		24, 12 VDC/24 VAC	24, 12, 6, 5, 3 VDC		
	Grommet	L plug connector	M plug connector	DIN terminal	M8 connector	M8 connector (EBC641-0-3 Standard)
G: Lead wire length 300 mm		L: With lead wire (Length 300 mm)	M: With lead wire (Length 300 mm)	D,Y: With connector	WO: Without connector cable	WA1: With connector cable (Length 0.3 m)
		MN: Without lead wire				WA2: With connector cable (Length 0.5 m)
		LO: Without connector		DO, YO: Without connector		WA3: With connector cable (Length 1 m)
	LN: Without lead wire		MO: Without connector			WA4: With connector cable (Length 2 m)
						WA5: With connector cable (Length 3 m)
						WA6: With connector cable (Length 4 m)
						WA7: With connector cable (Length 5 m)

- * LN, MN type: with 2 sockets.
 - * For DIN terminal of SY3000 series, refer to page 639.
 - * "Y" type is a DIN terminal conforming to EN-175301-803C (former DIN43650C). For details, refer to page 638.
 - * For connector cable of M8 connector, refer to page 641.
 - * For the M8 connector with a connector cable, only American certification (UL) is available.
 - * Refer to page 638 for the lead wire length of L and M plug connectors.
- Note) When ordering single unit of the base mounted type solenoid valve, the mounting screws and gaskets for the manifold are included.

Refer to the standard product for specifications and dimensions.



SJ
SY
SY
S0700
S0700

3 Port Solenoid Valve Body Ported/Single Unit



SY300/500 Series

How to Order

30-SY 5 1 3 **5 L** **01**

Series

3	SY300
5	SY500

UL standard compliant

Type of actuation

1	Normally closed (N.C.)
2	Normally open (N.O.)

Solenoid type

NII	Single solenoid
D	Double solenoid

Coil specifications

NII	Standard
T	With power saving circuit (24 VDC, 12 VDC only)

* Power saving circuit is not available in the case of D, Y, DO, YO or W□ type.

Rated voltage

DC	AC (%/Hz)
5	24 VDC
6	12 VDC
V	6 VDC
S	5 VDC
R	3 VDC
B	24 VAC

* DC specifications of type D, Y, DO and YO is only available with 12 and 24 VDC.
* For type W□, DC voltage is only available.

Thread type

NII	Rc
F	G
N	NPT
T	NPTF

* Except for M5

A port size Thread piping

Symbol	Port size	Applicable series
M5	M5 x 0.8	SY300
01	1/8	SY500

One-touch fitting (Metric size)

Symbol	Port size	Applicable series
C4	One-touch fitting for ø4	SY300
C6	One-touch fitting for ø6	
C4	One-touch fitting for ø4	SY500
C6	One-touch fitting for ø6	
C8	One-touch fitting for ø8	

One-touch fitting (inch size)

Symbol	Port size	Applicable series
N3	One-touch fitting for ø5/16"	SY300
N7	One-touch fitting for ø1/4"	
N3	One-touch fitting for ø5/16"	SY500
N7	One-touch fitting for ø1/4"	
N9	One-touch fitting for ø9/16"	

CE-compliant

NII	—
Q	CE-compliant

Made to Order

NII	—
X20	Body ported external pilot (Refer to page 624.)
X90	Main valve fluororubber (Refer to page 624.)

Bracket

NII: Without bracket
F1: With foot bracket (2 position (single only))
F2: With side bracket

Light/Surge voltage suppressor

Electrical entry for G, H, L, M, W

NII	Without light/surge voltage suppressor
S	With surge voltage suppressor
Z	With light/surge voltage suppressor
R	With surge voltage suppressor (Non-polar type)
U	With light/surge voltage suppressor (Non-polar type)

* For AC voltage valves there is no "S" option. It is already built-in to the rectifier circuit.
* For "R" and "U", DC voltage is only available.
* Power saving circuit is only available in the "Z" type

Electrical entry for D, Y

NII	Without light/surge voltage suppressor
S	With surge voltage suppressor
Z	With light/surge voltage suppressor

* DOZ and YOZ are not available.
* For AC voltage valves there is no "S" option. It is already built-in to the rectifier circuit.

Manual override

NII: Non-locking push type
D: Push-turn locking slotted type
E: Push-turn locking lever type

Electrical entry

24, 12, 6, 5, 3 VDC/24 VAC			24, 12 VDC/24 VAC	24, 12, 6, 5, 3 VDC	
Grommet	L plug connector	M plug connector	DIN terminal	M8 connector	M8 connector (IEC60947-5-2 Standard)
G: Lead wire length 300 mm	L: With lead wire (Length 300 mm)	M: With lead wire (Length 300 mm)	D: With connector	W0: Without connector cable	WAO: Without connector cable
H: Lead wire length 600 mm	LN: Without lead wire	MN: Without lead wire	DO: Without connector	W1: With connector cable (Length 300 mm)	WA1: With connector cable (Length 300 mm)
	LO: Without connector	MO: Without connector	Y: With connector	W2: With connector cable (Length 500 mm)	WA2: With connector cable (Length 500 mm)
			YO: Without connector	W3: With connector cable (Length 1000 mm)	WA3: With connector cable (Length 1000 mm)
				W4: With connector cable (Length 2000 mm)	WA4: With connector cable (Length 2000 mm)
				W5: With connector cable (Length 3000 mm)	WA5: With connector cable (Length 3000 mm)
				W6: With connector cable (Length 4000 mm)	WA6: With connector cable (Length 4000 mm)
				W7: With connector cable (Length 5000 mm)	WA7: With connector cable (Length 5000 mm)

- * LN, MN type: with 2 sockets.
- * For DIN terminal of SY300 series, refer to page 639.
- * "Y" type is a DIN terminal conforming to EN-175301-803C (former DIN43650C). For details, refer to page 638.
- * For connector cable of M8 connector, refer to page 641.
- * For the M8 connector with a connector cable, only American certification (UL) is available.
- * Refer to page 638 for the lead wire length of L and M plug connectors.

Note) When placing an order for body ported solenoid valve as a single unit, mounting screw for manifold and gasket are not attached. Order them separately, if necessary.
(Refer to page 467 for details.)

3 Port Solenoid Valve Base Mounted/Single Unit



SY300/500 Series

How to Order

30-SY 5 1 5 [] [] [] - **5 L** [] [] [] - [] [] [] - [] [] []

Series

3	SY300
5	SY500

UL standard compliant

Type of actuation

1	Normally closed (N.C.)
2	Normally open (N.O.)

Solenoid type

Nil	Single solenoid
D	Double solenoid

Pilot type

Nil	Internal pilot
R	External pilot

Coil specifications

Nil	Standard
T	With power saving circuit (24 VDC, 12 VDC only)

* Power saving circuit is not available in the case of D, Y, DO, YO or W□ type.

Rated voltage

DC	AC (50/60 Hz)
5	24 VDC
6	12 VDC
V	6 VDC
S	5 VDC
R	3 VDC

CE-compliant

Nil	—
Q	CE-compliant

Thread type

Nil	Rc
F	G
N	NPT
T	NPTF

Made to Order

Nil	—
X90	Main valve fluororubber (Refer to page 624.)

Port size

Symbol	Port size	Applicable series
Nil	Without sub-plate	
01	1/8 With sub-plate	SY300
02	1/4 With sub-plate	SY500

Manual override

Nil: Non-locking push type
D: Push-turn locking slotted type
E: Push-turn locking lever type

Light/Surge voltage suppressor

Electrical entry for G, H, L, M, W

Nil	Without light/surge voltage suppressor
S	With surge voltage suppressor
Z	With light/surge voltage suppressor
R	With surge voltage suppressor (Non-polar type)
U	With light/surge voltage suppressor (Non-polar type)

Electrical entry for D, Y

Nil	Without light/surge voltage suppressor
S	With surge voltage suppressor
Z	With light/surge voltage suppressor

* DOZ and YOZ are not available.
* For AC voltage valves there is no "S" option. It is already built-in to the rectifier circuit.
* For "R" and "U", DC voltage is only available.
* Power saving circuit is only available in the "Z" type

Electrical entry

24, 12, 6, 5, 3 VDC/24 VAC			24, 12 VDC/24 VAC		24, 12, 6, 5, 3 VDC		
Grommet	L plug connector	M plug connector	DIN terminal		M8 connector	M8 connector (IEC60947-5-2 Standard)	
G: Lead wire length 300 mm H: Lead wire length 600 mm	L: With lead wire (Length 300 mm) LN: Without lead wire LO: Without connector	M: With lead wire (Length 300 mm) MN: Without lead wire MO: Without connector	D: With connector DO: Without connector Y: With connector YO: Without connector		WO: Without connector cable W1: With connector cable (Length 300 mm) W2: With connector cable (Length 500 mm) W3: With connector cable (Length 1000 mm) W4: With connector cable (Length 2000 mm) W5: With connector cable (Length 3000 mm) W6: With connector cable (Length 4000 mm) W7: With connector cable (Length 5000 mm)	WA0: Without connector cable WA1: With connector cable (Length 300 mm) WA2: With connector cable (Length 500 mm) WA3: With connector cable (Length 1000 mm) WA4: With connector cable (Length 2000 mm) WA5: With connector cable (Length 3000 mm) WA6: With connector cable (Length 4000 mm) WA7: With connector cable (Length 5000 mm)	

- * LN, MN type: with 2 sockets.
 - * For DIN terminal of SY300 series, refer to page 639.
 - * "Y" type is a DIN terminal conforming to EN-175301-803C (former DIN43650C). For details, refer to page 638.
 - * For connector cable of M8 connector, refer to page 641.
 - * For the M8 connector with a connector cable, only American certification (UL) is available.
 - * Refer to page 638 for the lead wire length of L and M plug connectors.
- Note) When ordering single unit of the base mounted type solenoid valve, the mounting screws and gaskets for the manifold are included.



SY
SY
S0700
S0700

SY300/500 Series



Base Mounted/How to Order Valve

Plug-in: for SS5Y₅³-45□

Single solenoid 30 – SY **5** **1** 5 □ – **5** FU □ □ – □
 Double solenoid 30 – SY **5** **1** 5C □ – **5** FU □ □ – □

Series

3	SY300
5	SY500

Type of actuation

1	Normally closed (N.C.)
2	Normally open (N.C.)

Dual body type
 * When ordering double solenoid valves (Dual body type), please keep in mind that they require two manifold stations.

Pilot type

NII	Internal pilot
R	External pilot

Rated voltage

5	24 VDC
6	12 VDC

CE-compliant

NII	—
Q	CE-compliant

Made to Order

NII	—
X90	Main valve fluororubber (Refer to page 624.)

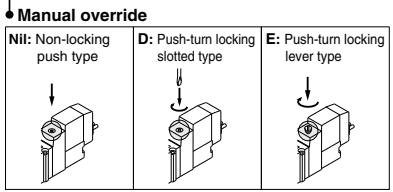

Plug-in: For SS5Y₅³-45F/45P□/45T/45T1

2 position single 30 – SY **3** 1 40 □ – **5** FU □ □ – □
 Double, 3 position 30 – SY **3** **2** 45 □ – **5** FU □ □ – □

Series

3	SY3000
5	SY5000

Type of actuation

2	2 position double
3	3 position closed center
4	3 position exhaust center
5	3 position pressure center

Dual body type (Double, 3 position)

Pilot type

NII	Internal pilot
R	External pilot

Rated voltage

5	24 VDC
6	12 VDC

CE-compliant

NII	—
Q	CE-compliant

Made to Order

NII	—
X90	Main valve fluororubber (Refer to page 624.)

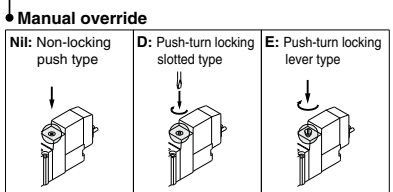



SY Series Specific Product Precautions 1

Be sure to read this before handling the products.
Refer to back page 50 for Safety Instructions and pages 3 to 9 for 3/4/5 Port Solenoid Valve Precautions.

Manual Override Operation

Warning

Non-locking push type [Standard]

Press in the direction of the arrow

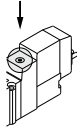

Push-turn locking slotted type [Type D]

While pressing, turn in the direction of the arrow.
If it is not turned, it can be operated the same way as the non-locking type.

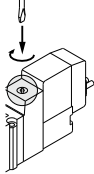

Locked position



Caution

When operating the locking type D with a screw driver, turn it gently using a watchmakers screw driver.
[Torque: Less than 0.1 N·m]

Push-turn locking lever type [Type E]

While pressing, turn it the direction of the arrow.
If it is not turned, it can be operated the same way as the non-locking type.

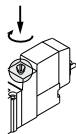

Locked position



Caution

When locking the manual override on the push-turn locking types (D, E), be sure to push it down before turning. Turning without first pushing it down can cause damage to the manual override and trouble such as air leakage, etc.

Solenoid Valve for 200, 220 VAC Specifications

Warning

Solenoid valves with grommet and L/M type plug connector AC specifications have a built-in rectifier circuit in the pilot section to operate the DC coil.

With 200 V, 220 VAC specification pilot valves, this built-in rectifier generates heat when energized. The surface may become hot depending on the energized condition; therefore, do not touch the solenoid valves.

Exhaust Throttle

Caution

With the SY series, the pilot valve and main valve share a common exhaust inside the valve. Therefore, do not block the exhaust port when arranging the piping.

SY3000/5000/7000/9000 Series Used as a 3-Port Valve

Caution

In case of using a 5-port valve as a 3-port valve
The SY3000/5000/7000/9000 series can be used as normally closed (N.C.) or normally open (N.O.) 3-port port valves by closing one of the cylinder ports (A or B) with a plug. However, they should be used with the exhaust ports kept open. (Refer to pages 610 to 615 for dedicated 3-port solenoid valve.)

Plug position	B port	A port
Configuration	N.C.	N.O.
Number of solenoids	Single	
	Double	

SJ

SY

SY

S0700

S0700



SY Series

Specific Product Precautions 2

Be sure to read this before handling the products.

Refer to back page 50 for Safety Instructions and pages 3 to 9 for 3/4/5 Port Solenoid Valve Precautions.

How to Use Plug Connector

⚠ Caution

1. Attaching and detaching connectors

- To attach a connector, hold the lever and connector unit between your fingers and insert straight onto the pins of the solenoid valve so that the lever's pawl is pushed into the groove and locks.
- To detach a connector, remove the pawl from the groove by pushing the lever downward with your thumb, and pull the connector straight out.

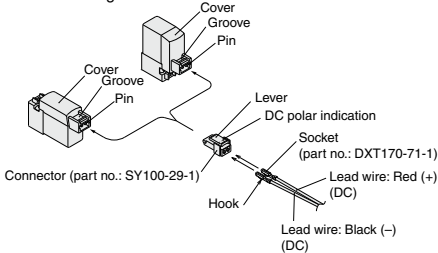

2. Crimping connection of lead wire and socket

Strip 3.2 to 3.7 mm at the end of lead wires, insert the end of the core wires evenly into the sockets, and then crimp it by a crimping tool. When this is done, take care that the coverings of the lead wires do not enter the core wire crimping area. (Please contact SMC for the dedicated crimping tools.)

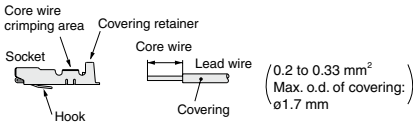

3. Attaching and detaching lead wires with sockets

• Attaching

Insert the sockets into the square holes of the connector (+, - indication), and continue to push the sockets all the way in until they lock by hooking into the seats in the connector.

(When they are pushed in, their hooks open and they are locked automatically.) Then confirm that they are locked by pulling lightly on the lead wires.

• Detaching

To detach a socket from a connector, pull out the lead wire while pressing the socket's hook with a stick having a thin tip (approx. 1 mm).

If the socket will be used again, first spread the hook outward.

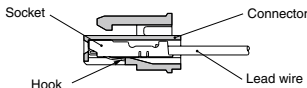

Surge Voltage Suppressor

⚠ Caution

<For DC>

Grommet, L/M Plug Connector

■ Polar type With surge voltage suppressor (□S)

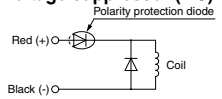

With light/surge voltage suppressor (□Z)

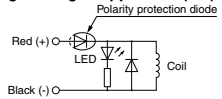

■ Non-polar type With surge voltage suppressor (□R)

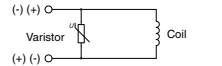

With light/surge voltage suppressor (□U)

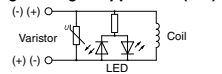

- Connect the standard type in accordance with the +, - polarity indication. (The non-polar type can be used with the connections made either way.)
- Since voltage specifications other than polar type 24 V and 12 VDC do not have diodes for polarity protection, be careful not to make errors in the polarity.
- When wiring is done at the factory, positive (+) is red and negative (-) is black.

■ With power saving circuit

Power consumption is decreased by 1/4 by reducing the wattage required to hold the valve in an energized state. (Effective energizing time is over 62 ms at 24 VDC.)

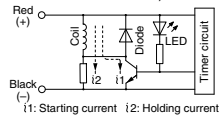

Operating Principle

With the above circuit, the current consumption when holding is reduced to save energy. Please refer to the electric wave data below.

- Please be careful not to reverse the polarity, since a diode to prevent the reversed current is not provided for the power saving circuit.

(In the case of SY₇³=0T, the electric wave form of energy saving type)

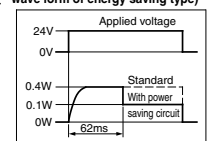



SY Series

Specific Product Precautions 3

Be sure to read this before handling the products.

Refer to back page 50 for Safety Instructions and pages 3 to 9 for 3/4/5 Port Solenoid Valve Precautions.

Surge Voltage Suppressor

DIN Terminal

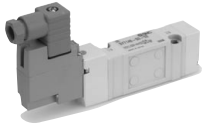

With surge voltage suppressor (DS)

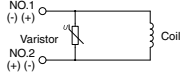

With light/surge voltage suppressor (DZ)

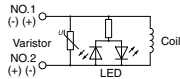

DIN terminal has no polarity.

M8 Connector

■ Polar type

With surge voltage suppressor (□S)

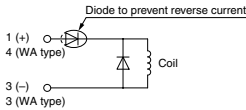

With light/surge voltage suppressor (□Z)

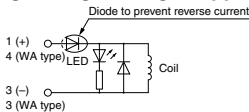

■ Non-polar type

With surge voltage suppressor (□R)

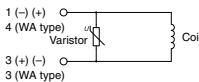

With light/surge voltage suppressor (□U)

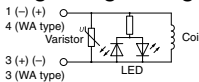

Solenoid valve side pin wiring diagram

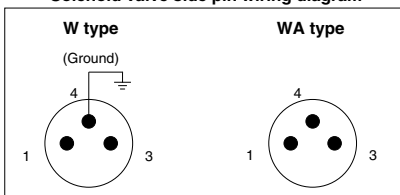

Note) The WA-type valve cannot be grounded.

M8 Connector

- For wiring of the polar type, connect + to 1 and – to 3 for Type W, while + to 4 and – to 3 for Type WA.
- Since voltage specifications other than polar type 24 V and 12 VDC do not have diodes for polarity protection, be careful not to make errors in the polarity.

Plug-in

Circuit for non-polar (FU)

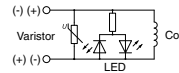

Plug-in valve has no polarity, so its possible to use for both manifold bases for positive (SS5Y²-45□) and negative its common (SS5Y²-45N□) types.

<For AC>

(There is no "S" option, because the generation of surge voltage is prevented by a rectifier.)

Grommet, L/M Plug Connector

With light

**[GZ
LZ, LOZ, MZ, MOZ]**

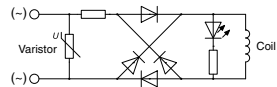

DIN Terminal

With light (YZ)

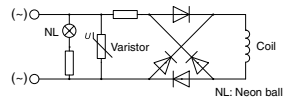

Note) Surge voltage suppressor of varistor has residual voltage corresponding to the protective element and rated voltage; therefore, protect the controller side from the surge voltage. The residual voltage of the diode is approximately 1 V.

SJ

SY

SY

S0700

S0700



SY Series

Specific Product Precautions 4

Be sure to read this before handling the products.

Refer to back page 50 for Safety Instructions and pages 3 to 9 for 3/4/5 Port Solenoid Valve Precautions.

Plug Connector Lead Wire Length

⚠ Caution

Standard length is 300mm, but the following lengths are also available.

How to Order Connector Assembly

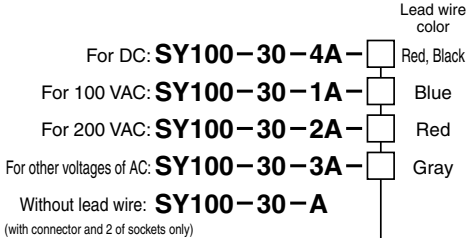

• How to Order

Specify the part numbers of the solenoid valve without connector and the connector assembly with protective cover separately.

<Example> Lead wire length 2000 mm

For DC	For AC
SY3120-5LO-M5	SY3120-1LO-M5
SY100-30-4A-20	SY100-30-1A-20

Lead wire length	
Nil	300 mm
6	600 mm
10	1000 mm
15	1500 mm
20	2000 mm
25	2500 mm
30	3000 mm
50	5000 mm

How to Use DIN Terminal

⚠ Caution

Connection

1. Loosen the holding screw and pull the connector out of the solenoid valve terminal block.
2. After removing the holding screw, insert a flat head screwdriver, etc. into the notch on the bottom of the terminal block and pry it open, separating the terminal block and the housing.
3. Loosen the terminal screws (slotted screws) on the terminal block, insert the cores of the lead wires into the terminals according to the connection method, and fasten them securely with the terminal screws.
4. Secure the cord by fastening the gland nut.

⚠ Caution

When making connections, take note that using other than the supported size ($\phi 3.5$ to $\phi 7$) heavy duty cord will not satisfy IP65 (enclosure) standards. Also, be sure to tighten the gland nut and holding screw within their specified torque ranges.

Changing the entry direction

After separating the terminal block and housing, the cord entry can be changed by attaching the housing in the desired direction (4 directions at 90° intervals).

* When equipped with a light, be careful not to damage the light with the cord's lead wires.

Precautions

Plug in and pull out the connector vertically without tilting to one side.

Compatible cable

Cord O.D.: $\phi 3.5$ to $\phi 7$

(Reference) 0.5mm², 2-core or 3-core, equivalent to JIS C 3306

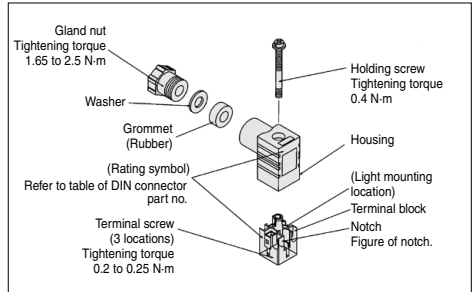

Type "Y"

DIN connector type Y is a DIN connector that conforms to the DIN pitch 8-mm standard.

- D type DIN connector with 9.4 mm pitch between terminals is not interchangeable.
- To distinguish from the D type DIN connector, "N" is listed at the end of voltage symbol. (For connector parts without lights, "N" is not indicated. Please refer to the name plate to distinguish.)
- Dimensions are completely the same as D type DIN connector.
- When exchanging the pilot valve assembly only, "V115-□□" is interchangeable with "V115-□□Y". Do not replace V111 (G, L, M) to V115-□□□□ (DIN terminal), and vice versa.



SY Series Specific Product Precautions 5

Be sure to read this before handling the products.

Refer to back page 50 for Safety Instructions and pages 3 to 9 for 3/4/5 Port Solenoid Valve Precautions.

SY300, SY3000 Series How to Use DIN Terminal Connector

Caution

- SMC can provide a DIN type terminal connector (body ported type, sub-plate type) for the SY300 and SY3000 series. This cannot be assembled to a standard manifold and sub-plate since the DIN connector width (15.8mm) exceeds that of the valve body (10mm). Contact SMC if you wish to use with a manifold and sub-plate. Please also note: that bracket F1 cannot be mounted.
- * The DIN terminal connector has no body ported external pilot specifications for both single unit and manifold.

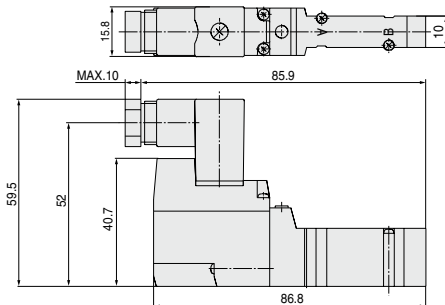

DIN Connector Part No.

Caution

<Type D>

Without light	SY100-61-1
---------------	------------

With light

Rated voltage	Voltage symbol	Part no.
24 VDC	24 V	SY100-61-3-05
12 VDC	12 V	SY100-61-3-06
100 VAC	100 V	SY100-61-2-01
200 VAC	200 V	SY100-61-2-02
110 VAC	110 V	SY100-61-2-03
220 VAC	220 V	SY100-61-2-04

<Type Y>

Without light	SY100-82-1
---------------	------------

With light

Rated voltage	Voltage symbol	Part no.
24 VDC	24 VN	SY100-82-3-05
12 VDC	12 VN	SY100-82-3-06
100 VAC	100 VN	SY100-82-2-01
200 VAC	200 VN	SY100-82-2-02
110 VAC (115 VAC)	110 VN	SY100-82-2-03
220 VAC (230 VAC)	220 VN	SY100-82-2-04

Circuit Diagram with Light

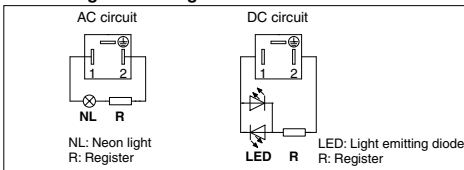

Connector Assembly with Cover

Caution

Connector assembly with dust proof protective cover.

- Effective to prevention of short circuit failure due to the entry of foreign matter into the connector.
- Chloroprene rubber for electrical use, which provides outstanding weather resistance and electrical insulation, is used for the cover material. However, do not allow contact with cutting oil, etc.
- Simple and unencumbered appearance by adopting round-shaped cord.

How to Order

SY100-68-A - □

• Lead wire length (L)

Nil	300 mm
6	600 mm
10	1000 mm
15	1500 mm
20	2000 mm
25	2500 mm
30	3000 mm
50	5000 mm

Connector Assembly with Cover: Dimensions

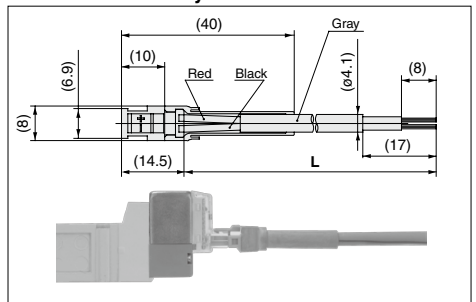

How to Order

Enter the part number for a plug connector solenoid valve without connector together with the part number for a connector assembly with cover.

<Example 1> Lead wire length of 2000 mm

SY3120-5LOZ-M5

SY100-68-A-20

<Example 2> Lead wire length of 300 mm (standard)

SY3120-5LPZ-M5

□ Symbol for connector assembly with cover

* In this case, the part number for the connector assembly with cover is not required.



SY Series

Specific Product Precautions 6

Be sure to read this before handling the products.

Refer to back page 50 for Safety Instructions and pages 3 to 9 for 3/4/5 Port Solenoid Valve Precautions.

Plug-in

⚠ Caution

■ When using a double solenoid valve (Dual body type: SY₂³245-□FU) on the plug-in type manifold (SS5Y₃45(N)□), two manifold stations are required per valve.

Output to A/B ports will be made through the manifold block on the side indicated by an arrow on the top of the solenoid valve. Therefore, arrange the piping on the side indicated by the arrow.

Although the "T" side will not be used, plugs will not be necessary since it is sealed with the valve.

(However, insert a plug into the A/B ports if dust intrusion is possible. Refer to page 567.)

Manifold valve

SS5Y₃²-45 (N)□

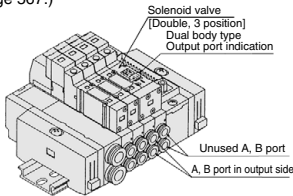

Plug-in type solenoid valves consist of a non-polar solenoid valve and a plug-in socket. When ordering them separately, refer to the following part numbers.

[Single solenoid]

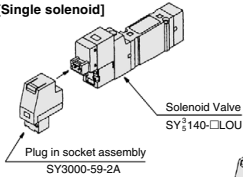

[Double, 3 position Dual body type]

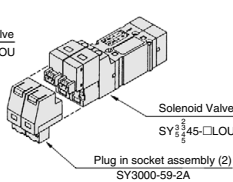

Note) Using a valve other than a non-polar type may cause trouble.

DIN Rail for SY7000/9000 Series

⚠ Caution

The DIN rail used with the SY7000 and SY9000 series is stronger than that used with the SY3000 and SY5000 series. Use this exclusive DIN rail with the SY7000 and SY9000 series. Furthermore, if using a DIN rail other than that supplied by SMC, refer to the manifold mounting section below, and mount using the same method as prescribed for side facing and rear facing, regardless of the mounting orientation.

Manifold Mounting

⚠ Caution

1. For Type 23, 43, 45, 45□ and 60 DIN rail mounting, when attaching a manifold to a mounting surface, etc., with bolts, if the entire bottom surface of the DIN rail contacts the mounting surface in a horizontal mounting, it can be used by simply securing both ends of the DIN rail. However, for any other mounting method or for side facing and rear facing, etc., secure the DIN rail with bolts at uniform intervals using the following as a guide: 2 to 5 stations at 2 locations, 6 to 10 stations at 3 locations, 11 to 15 stations at 4 locations, and 16 to 20 stations at 5 locations. In addition, even in the case of a horizontal mounting, if the mounting surface is subject to vibration, etc., take the same measures indicated above. If secured at fewer than the specified number of locations, warping or twisting may occur in the DIN rail and manifold, causing trouble such as air leakage.

Also, when using mounting screws for the DIN rail on the bottom side (L3 dimension in the dimension table) of the manifold valve body, the height of the screw head has to be as follows.

Type 23, 43 (SY9000): 8 mm or less

Type 45 (SY3000, 5000): 5.8 mm or less

For type 60:

SY3000: 4.7 mm or less

SY5000: 5.8 mm or less

SY7000: 8 mm or less

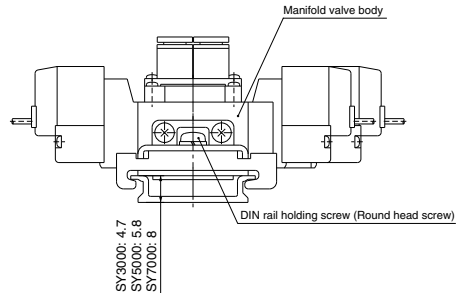

[This is the case for type 60.]

2. There will be slight variations in the width of manifold blocks due to tolerance (±0.15 mm) for the stacking manifold type of the SS5Y9-23 series and SS5Y9-43 series.

As the manifold is made up of a combination of manifold blocks, there will be an error due to accumulated tolerance between the actual pitch dimensions of the mounting holes used to secure the manifold and the values stated in the catalog. Keep this in mind when increasing the number of stations.



SY Series

Specific Product Precautions 7

Be sure to read this before handling the products.

Refer to back page 50 for Safety Instructions and pages 3 to 9 for 3/4/5 Port Solenoid Valve Precautions.

One-touch Fittings

⚠ Caution

When fittings are used, they may interfere with one another depending on their types and sizes. Therefore, the dimensions of the fittings to be used should first be confirmed in their respective catalogs.

• Tubing attachment/detachment for One-touch fittings

1) Attaching of tubing

1. Take a tubing having no flaws on its periphery and cut it off at a right angle. When cutting the tubing, use tubing cutters TK-1, 2 or 3. Do not use pinchers, nippers or scissors, etc. If cutting is done with tools other than tubing cutters, the tubing may be cut diagonally or become flattened, etc., making a secure installation impossible, and causing problems such as the tubing pulling out after installation or air leakage. Allow some extra length in the tubing.
2. Grasp the tubing, slowly push it straight (0 to 5°) into the One-touch fitting until it comes to a stop.
3. After inserting the tubing, pull on it lightly to confirm that it will not come out. If it is not installed securely all the way into the fitting, this can cause problems such as air leakage or the tubing pulling out.

2) Detaching of tubing

1. Push in the release button sufficiently, pushing its collar equally around the circumference.
2. Pull out the tubing while holding down the release button so that it does not come out. If the release button is not pressed down sufficiently, there will be increased bite on the tubing and it will become more difficult to pull it out.
3. When the removed tubing is to be used again, cut off the portion which has been chewed before reusing it. If the chewed portion of the tubing is used as is, this can cause trouble such as air leakage or difficulty in removing the tubing.

Other Tubing Brands

⚠ Caution

1. When using other than SMC brand tubing, confirm that the following specifications are satisfied with respect to the outside diameter tolerance of the tubing.

- | | |
|------------------------|-------------------------------------|
| 1) Nylon tubing | within ±0.1 mm |
| 2) Soft nylon tubing | within ±0.1 mm |
| 3) Polyurethane tubing | within +0.15 mm,
within -0.2 mm. |

Do not use tubing which do not meet these outside diameter tolerances. It may not be possible to connect them, or they may cause other trouble, such as air leakage or the tubing pulling out after connection.

M8 Connector

⚠ Caution

1. M8 connector types have an IP65 (enclosure) rating, offering protection from dust and water. However please note: these products are not intended for use in water. Select a SMC connector cable (V100-49-1-□) or a FA sensor type connector, with M8 threaded 3 pin specifications conforming to Nippon Electric Control Equipment Association Standard, NECA4202 (IEC60947-5-2). Make sure the connector O.D. is 10.5mm or less when used with the SY3000 series manifold. If more than 10.5mm, it cannot be mounted due to the size.
2. Do not use a tool to mount the connector, as this may cause damage. Only tighten by hand. (0.4 to 0.6 N·m)
3. The excessive stress on the cable connector will not be able to satisfy the IP65 rating. Please use caution and do not apply a stress of 30 N or greater.

⚠ Caution

Failure to meet IP65 performance may result if using alternative connectors than those shown above, or when insufficiently tightened.

Connector cable mounting



Note) Connector cable should be mounted in the correct direction. Make sure that the arrow symbol on the connector is facing the triangle symbol on the valve when using SMC connector cable (V100-49-1-□).

Be careful not to squeeze it in the wrong direction, as problems such as pin damage may occur.

SJ

SY

SY

S0700

S0700



SY Series

Specific Product Precautions 8

Be sure to read this before handling the products.

Refer to back page 50 for Safety Instructions and pages 3 to 9 for 3/4/5 Port Solenoid Valve Precautions.

M8 Connector

⚠ Caution

■ Connector cable

- Connector cable for M8 can be ordered as follows:
- Refer to page 637 for the surge voltage suppressor.

How to Order

- To order solenoid valve and connector cable at the same time.
(Connector cable will be included in the shipment of the solenoid valve.)

SY ³/₅/₉ □ □ □ □ - □ W □ 1 - □ □

IEC Standards compliant

Nil	None
A	IEC60947-2 compliant

Cable length (mm)

Symbol	Cable length (mm)
1	300
2	500
3	1000
4	2000
5	3000
6	4000
7	5000

Ex. 1) Cable length: 300mm

SY312-5W1ZE-C4

Symbol for electrical entry

- To order connector cable only

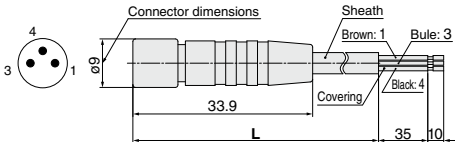

Cable length (L)	Part no.
300 mm	V100-49-1-1
500 mm	V100-49-1-2
1000 mm	V100-49-1-3
2000 mm	V100-49-1-4
5000 mm	V100-49-1-7
3000 mm	V100-49-1-5
4000 mm	V100-49-1-6

Sheath O.D.	ø3.4 mm
Cover diameter	ø1.16 mm
Conductor area	0.16 mm ²

[Dimensions when installed]

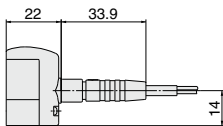

Solenoid Valve Mounting

⚠ Caution

Mount it so that there is no slippage or deformation in gaskets, and tighten with the tightening torque as shown below.

Model	Thread size	Tightening torque
SY3000	M2	0.16 N·m
SY5000	M3	0.8 N·m
SY7000	M4	1.4 N·m
SY9000	M3	0.8 N·m

Replacement of Pilot Valve

⚠ Caution

Pilot valves in this series are improved to provide excellent energy saving results. However following this improvement, these new valves are no longer compatible with the current pilot valve used at the interface. Consult with SMC when you need to exchange these pilot valves, in the case of manual override (marked in orange) of the adapter plate.

New type

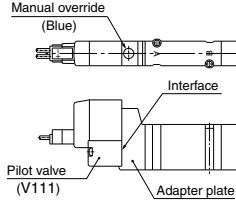

Current type

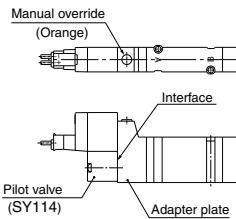



SY Series

Specific Product Precautions 9

Be sure to read this before handling the products.

Refer to back page 50 for Safety Instructions and pages 3 to 9 for 3/4/5 Port Solenoid Valve Precautions.

Interface Regulator

Caution

Specifications

Interface regulator model	ARBY3000-□-P-2	ARBY3000-□-A1 B1-2	ARBY5000-□-P-2	ARBY5000-□-A1 B1-2	ARBY7000-□-P-2	ARBY7000-□-A1 B1-2
Applicable solenoid valve model	SY3□40(R)		SY5□40(R)		SY7□40(R)	
Regulated port	P	A B	P	A B	P	A B
Set pressure range	0.1 to 0.7 MPa					
Maximum operating pressure	0.7 MPa					
Fluid	Air					
Ambient and fluid temperature	Max. 50°C					
Connection port of pressure gauge	M5 x 0.8					
Weight W (g)	With pressure gauge				110.8 g	
	With plug				103.2 g	
Supply side effective area ¹⁾	46 g (05), 50 g (06)				110.8 g	
Exhaust side effective area ²⁾	20 g				103.2 g	
Supply side effective area ³⁾	P→A,B				13.54 mm ²	
Exhaust side effective area ³⁾	A,B→EA,EB				15.71 mm ²	
	4.05 mm ²		3.91 mm ²		11.1 mm ²	
			66.8 g		7.61 mm ²	
			60.4 g		10.1 mm ²	
					15.71 mm ²	
					15.71 mm ²	

Note 1) Pressurize the interface regulator from P port on the base.

Note 2) With closed center and pressure center valves, the pressure can be regulated through P port only.

Note 3) Effective area, excluding the regulated port, when a primary pressure of 0.5 MPa is supplied with regulators mounted on the solenoid valves (2 positions) and a sub-plate. Refer to "Flow Rate Characteristics" regarding the regulated port.

Note 4) Valves for weight include gasket and mounting screws.

Note 5) With A, B ports regulated (P port controlled A, B ports regulated), the effective area (Cv factor) for the regulated port and unregulated passage (P to B or P to A) decreases as shown in the graph below when the set pressure is 0.25 MPa or less.

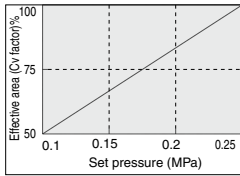

Symbol

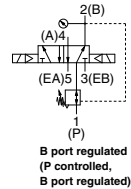
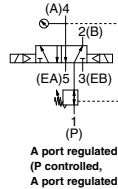
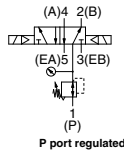

How to Order Interface Regulator

ARBY3000 - 05 - P - 2

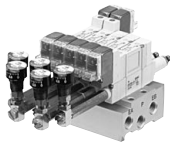

Regulated port

P	P port
A1	A port (P controlled, A port regulated)
B1	B port (P controlled, B port regulated)

Pressure gauge connection port

05	Pressure gauge (G15-10-01) [for odd number stations]
06	Pressure gauge (G15-10-01) [for even number stations]
M1	Plug (M-5P)

Note) For the ARBY3000 series with pressure gauge, note that the part numbers for odd number and even number stations differ to prevent interference between the pressure gauges when installing on the manifold.

ARBY5000 - 00 - P - 2



Regulated port

P	P port
A1	A port (P controlled, A port regulated)
B1	B port (P controlled, B port regulated)

Pressure gauge connection port

00	Pressure gauge (G15-10-01)
M1	Plug (M-5P)

ARBY7000 - 00 - P - 2

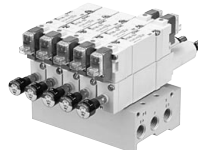

Regulated port

P	P port
A1	A port (P controlled, A port regulated)
B1	B port (P controlled, B port regulated)

Pressure gauge connection port

00	Pressure gauge (G15-10-01)
M1	Plug (M-5P)

Note) The M8 connector for wiring cannot be mounted for the ARBY3000 series.



SY Series

Specific Product Precautions 10

Be sure to read this before handling the products.

Refer to back page 50 for Safety Instructions and pages 3 to 9 for 3/4/5 Port Solenoid Valve Precautions.

Flow Rate Characteristics

(Conditions: Inlet pressure 0.7 MPa when 2 position solenoid valve is mounted.)

ARBY3000

P port regulated (P→A, B)

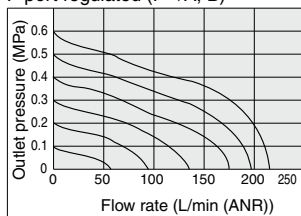

A1 port regulated (P→A),

B1 port regulated (P→B)

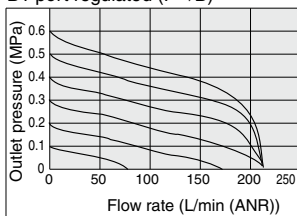

ARBY5000

P port regulated (P→A, B)

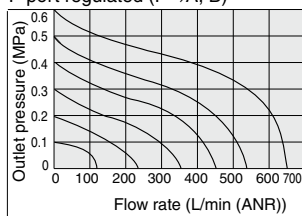

A1 port regulated (P→A),

B1 port regulated (P→B)

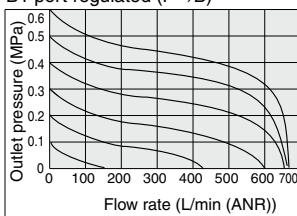

ARBY7000

P port regulated (P→A, B)

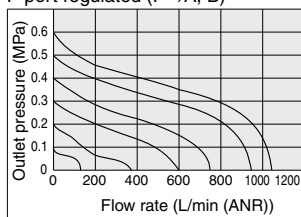

A1 port regulated (P→A),

B1 port regulated (P→B)

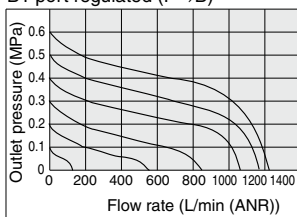

■Trademark

DeviceNet™ is a trademark of ODVA.

Model Index (Alphanumerical Order)

SS5Y3-20	SY Type 20 Body Ported Manifold: Bar Stock Type/Individual Wiring	P. 438
SS5Y3-20P	SY Type 20P Body Ported Manifold: Bar Stock Type/Flat Ribbon Cable	P. 448
SS5Y3-20SA	SY EX510 Gateway-type Body Ported Manifold/Bar Stock Type	P. 458
SS5Y3-41	SY Type 41 Base Mounted Manifold: Bar Stock Type/Individual Wiring	P. 490
SS5Y3-41P	SY Type 41P Base Mounted Manifold: Bar Stock Type/Flat Ribbon Cable	P. 506
SS5Y3-42	SY Type 42 Base Mounted Manifold: Bar Stock Type/Individual Wiring	P. 490
SS5Y3-42P	SY Type 42P Base Mounted Manifold: Bar Stock Type/Flat Ribbon Cable	P. 506
SS5Y3-42SA	SY EX510 Gateway-type Base Mounted Manifold/Bar Stock Type	P. 520
SS5Y3-45	SY Type 45 Base Mounted Manifold: Stacking Type/DIN Rail/Individual Wiring	P. 536
SS5Y3-45-□	SY Type 45-□ Base Mounted Manifold: Stacking Type/DIN Rail/Connector Box	P. 548
SS5Y3-45F	SY Type 45F Base Mounted Manifold: D-sub Connector, 25 Pins	P. 564
SS5Y3-45P	SY Type 45P Base Mounted Manifold: Flat Ribbon Cable	P. 565
SS5Y3-45S	SY EX122 Integrated-type (For output) Base Mounted Manifold	P. 594
SS5Y3-45S1	SY EX121 Separate Type (For output) Base Mounted Manifold	P. 597
SS5Y3-45S6A	SY EX510 Gateway-type Base Mounted Manifold: Stacking Type	P. 556
SS5Y3-45S6B	SY EX510 Gateway-type Base Mounted Manifold/Stacking Type/Plug-in	P. 604
SS5Y3-45T	SY Type 45T Base Mounted Manifold: 9 Pins Terminal Block	P. 565
SS5Y3-45T1	SY Type 45T1 Base Mounted Manifold: 18 Pins Terminal Block	P. 565
SS5Y3-60	SY Type 60 Body Ported Manifold: Cassette Type	P. 472
SS5Y5-20	SY Type 20 Body Ported Manifold: Bar Stock Type/Individual Wiring	P. 438
SS5Y5-20P	SY Type 20P Body Ported Manifold: Bar Stock Type/Flat Ribbon Cable	P. 448
SS5Y5-20SA	SY EX510 Gateway-type Body Ported Manifold/Bar Stock Type	P. 458
SS5Y5-41	SY Type 41 Base Mounted Manifold: Bar Stock Type/Individual Wiring	P. 490
SS5Y5-41P	SY Type 41P Base Mounted Manifold: Bar Stock Type/Flat Ribbon Cable	P. 506
SS5Y5-42	SY Type 42 Base Mounted Manifold: Bar Stock Type/Individual Wiring	P. 490
SS5Y5-42P	SY Type 42 Base Mounted Manifold: Bar Stock Type/Individual Wiring	P. 506
SS5Y5-42SA	SY EX510 Gateway-type Base Mounted Manifold/Bar Stock Type	P. 520
SS5Y5-45	SY Type 45 Base Mounted Manifold: Stacking Type/DIN Rail/Individual Wiring	P. 536
SS5Y5-45-□	SY Type 45-□ Base Mounted Manifold: Stacking Type/DIN Rail/Connector Box	P. 548
SS5Y5-45F	SY Type 45F Base Mounted Manifold: D-sub Connector, 25 Pins	P. 564
SS5Y5-45P	SY Type 45P Base Mounted Manifold: Flat Ribbon Cable	P. 565
SS5Y5-45S	SY EX122 Integrated-type (For output) Base Mounted Manifold	P. 594
SS5Y5-45S1	SY EX121 Separate Type (For output) Base Mounted Manifold	P. 597
SS5Y5-45S6A	SY EX510 Gateway-type Base Mounted Manifold: Stacking Type	P. 556
SS5Y5-45S6B	SY EX510 Gateway-type Base Mounted Manifold/Stacking Type/Plug-in	P. 604
SS5Y5-45T	SY Type 45T Base Mounted Manifold: 9 Pins Terminal Block	P. 565
SS5Y5-45T1	SY Type 45T1 Base Mounted Manifold: 18 Pins Terminal Block	P. 565
SS5Y5-60	SY Type 60 Body Ported Manifold: Cassette Type	P. 472
SS5Y7-20	SY Type 20 Body Ported Manifold: Bar Stock Type/Individual Wiring	P. 438
SS5Y7-20P	SY Type 20P Body Ported Manifold: Bar Stock Type/Flat Ribbon Cable	P. 448
SS5Y7-20SA	SY EX510 Gateway-type Body Ported Manifold/Bar Stock Type	P. 458
SS5Y7-42	SY Type 42 Base Mounted Manifold: Bar Stock Type/Individual Wiring	P. 490
SS5Y7-42P	SY Type 42P Base Mounted Manifold: Bar Stock Type/Flat Ribbon Cable	P. 506
SS5Y7-42SA	SY EX510 Gateway-type Base Mounted Manifold/Bar Stock Type	P. 520
SS5Y7-60	SY Type 60 Body Ported Manifold: Cassette Type	P. 472
SS5Y9-23	SY Type 23 Body Ported Manifold: Stacking Type/Individual Wiring	P. 444

SS5Y9-23P	SY Type 23P Body Ported Manifold: Stacking Type/Flat Ribbon Cable	P. 454
SS5Y9-23SA	SY EX510 Gateway-type Body Ported Manifold/Stacking Type	P. 464
SS5Y9-43	SY Type 43 Base Mounted Manifold: Stacking Type/Individual Wiring	P. 500
SS5Y9-43P	SY Type 43P Base Mounted Manifold: Stacking Type/Flat Ribbon Cable	P. 514
SS5Y9-43SA	SY EX510 Gateway-type Base Mounted Manifold: Stacking Type	P. 525
SY300	3 Port Valve: Mixed Mounting Type on 5 Port Valve Manifold	P. 610
SY300-WA□	Made to Order M8 Connector Conforming to IEC60947-5-2	P. 623
SY3000	5 Port Solenoid Valve: Body Ported/Single Unit	P. 404
SY3000	5 Port Solenoid Valve: Base Mounted/Single Unit	P. 420
SY3000-WA□	Made to Order M8 Connector Conforming to IEC60947-5-2	P. 623
SY3000-X20	Made to Order Body Ported External Pilot	P. 624
SY3000-X90	Made to Order Body Ported Fluororubber for Main Valve	P. 624
SY500	3 Port Valve: Mixed Mounting Type on 5 Port Valve Manifold	P. 610
SY500-WA□	Made to Order M8 Connector Conforming to IEC60947-5-2	P. 623
SY5000	5 Port Solenoid Valve: Body Ported/Single Unit	P. 404
SY5000	5 Port Solenoid Valve: Base Mounted/Single Unit	P. 420
SY5000-WA□	Made to Order M8 Connector Conforming to IEC60947-5-2	P. 623
SY5000-X20	Made to Order Body Ported External Pilot	P. 624
SY5000-X90	Made to Order Body Ported Fluororubber for Main Valve	P. 624
SY5A2R	Made to Order Body Ported Vacuum Release Valve with Throttle Valve	P. 625
SY7000	5 Port Solenoid Valve: Body Ported/Single Unit	P. 404
SY7000	5 Port Solenoid Valve: Base Mounted/Single Unit	P. 420
SY7000-WA□	Made to Order M8 Connector Conforming to IEC60947-5-2	P. 623
SY7000-X20	Made to Order Body Ported External Pilot	P. 624
SY7000-X90	Made to Order Body Ported Fluororubber for Main Valve	P. 624
SY9000	5 Port Solenoid Valve: Body Ported/Single Unit	P. 404
SY9000	5 Port Solenoid Valve: Base Mounted/Single Unit	P. 420
SY9000-WA□	Made to Order M8 Connector Conforming to IEC60947-5-2	P. 623
SY9000-X90	Made to Order Body Ported Fluororubber for Main Valve	P. 624

Others

30-SY300	UL Standard Compliant 3 Port Solenoid Valve: Body Ported/Single Unit	P. 632
30-SY300	UL Standard Compliant 3 Port Solenoid Valve: Base Mounted/Single Unit	P. 633
30-SY3000	UL Standard Compliant 5 Port Solenoid Valve: Body Ported/Single Unit	P. 630
30-SY3000	UL Standard Compliant 5 Port Solenoid Valve: Base Mounted/Single Unit	P. 631
30-SY500	UL Standard Compliant 3 Port Solenoid Valve: Body Ported/Single Unit	P. 632
30-SY500	UL Standard Compliant 3 Port Solenoid Valve: Base Mounted/Single Unit	P. 633
30-SY5000	UL Standard Compliant 5 Port Solenoid Valve: Body Ported/Single Unit	P. 630
30-SY5000	UL Standard Compliant 5 Port Solenoid Valve: Base Mounted/Single Unit	P. 631
30-SY7000	UL Standard Compliant 5 Port Solenoid Valve: Body Ported/Single Unit	P. 630
30-SY7000	UL Standard Compliant 5 Port Solenoid Valve: Base Mounted/Single Unit	P. 631
30-SY9000	UL Standard Compliant 5 Port Solenoid Valve: Body Ported/Single Unit	P. 630
30-SY9000	UL Standard Compliant 5 Port Solenoid Valve: Base Mounted/Single Unit	P. 631

SJ

SY

SY

S0700

S0700